

---

# PG-PLUS

## INTEGRATED CENTRAL OFFICE LINE UNIT

Model	List Number	Part Number	CLEI Code
PLL-725	1	150-1625-01	S9L1AG0AAA

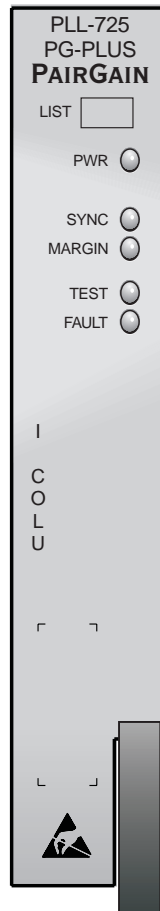

**PAIRGAIN TECHNOLOGIES, INC.**  
**ENGINEERING SERVICES TECHNICAL PRACTICE**



**SECTION 950-725-100-01**

---

**Revision History of This Practice**

Revision	Release Date	Revisions Made
01	February 19, 1999	Initial Release

**©Copyright 1999 PairGain Technologies, Inc.**

*PairGain and PG-Plus are trademarks of PairGain Technologies, Inc.*

*Information contained in this document is company private to PairGain Technologies, Inc., and shall not be modified, used, copied, reproduced or disclosed in whole or in part without the written consent of PairGain.*

*Other product names mentioned in this practice are used for identification purposes only and may be trademarks or registered trademarks of their respective companies.*

## USING THIS TECHNICAL PRACTICE

Two types of messages, identified by icons, appear in the text:



**Notes contain information about special circumstances.**



**Cautions indicate the possibility of equipment damage or the possibility of personal injury.**

## INSPECTING YOUR SHIPMENT

Upon receipt of the equipment:

- Unpack each container and visually inspect it for signs of damage. If the equipment has been damaged in transit, immediately report the extent of damage to the transportation company and to PairGain. Order replacement equipment, if necessary.
- Check the packing list to ensure complete and accurate shipment of each listed item. If the shipment is short or irregular, contact PairGain as described in the Warranty. If you must store the equipment for a prolonged period, store the equipment in its original container.

## ABBREVIATIONS

<b>ACO</b>	Alarm Cut-Off	<b>MJ</b>	Major
<b>AFE</b>	Analog Front End	<b>MLT</b>	Mechanized Loop Testing
<b>AWG</b>	American Wire Gauge	<b>MN</b>	Minor
<b>BER</b>	Bit Error Ratio	<b>NA</b>	Not Alarmed
<b>CEV</b>	Controlled Environmental Vault	<b>NORLUSW</b>	NO RLU Software
<b>CO</b>	Telco Central Office.	<b>NR</b>	Not Reported
<b>COLU</b>	Central Office Line Unit	<b>NT1</b>	Network Termination Type-1
<b>COTS</b>	Central Office Terminal Shelf	<b>PAU</b>	PG-Plus Alarm Unit
<b>CR</b>	Critical	<b>PFO</b>	Power Feed Open
<b>DDS</b>	Digital Data Service	<b>PFS</b>	Power Feed Short
<b>ES</b>	Errored Seconds	<b>PGF</b>	Power Feed Ground Fault
<b>FCC</b>	Federal Communications Commission	<b>PMU</b>	PG-Plus Management Unit
<b>HDSL</b>	High-bit-rate Digital Subscriber Line	<b>PMX</b>	PG-Plus Multiplexer Unit
<b>IDLC</b>	Integrated Digital Loop Carrier	<b>POTS</b>	Plain Old Telephone Service
<b>ISDN</b>	Integrated Services Digital Network	<b>RLU</b>	Remote Line Unit
<b>LED</b>	Light Emitting Diode	<b>RMA</b>	Return Materials Authorization
<b>LOSW</b>	HDSL Loss of SYNC Word	<b>RT</b>	Remote Terminal
<b>mA</b>	milli-Amps	<b>SCB</b>	Serial Communication Bus
<b>mV<sub>pp</sub></b>	milli-volts peak-to-peak	<b>SDT</b>	Subscriber Drop Test
<b>MAR</b>	Line Margin	<b>SES</b>	Severely Errored Seconds
<b>MISPWRA</b>	Power A Missing	<b>SYNC</b>	Synchronization
<b>MISPWRB</b>	Power B Missing	<b>UAS</b>	Unavailable Seconds counts
		<b>UVG</b>	

# TABLE OF CONTENTS

<b>Product Overview</b> .....	1
Description .....	1
Specifications .....	2
Power Consumption and Heat Dissipation .....	3
Maximum Heat Dissipation .....	3
Thermal Loading Limitations .....	3
Maximum Power Consumption .....	4
Maximum Current Drain.....	4
Monitoring, History, and Diagnostics .....	4
Performance Parameters .....	4
Alarms and Alarm Values.....	5
History.....	5
LEDs Descriptions.....	5
<b>Installation and Test</b> .....	6
Required Tools and Test Equipment .....	6
Installing the ICOLU .....	7
Initialization Sequence .....	7
Subscriber Drop Tests .....	8
<b>Administration</b> .....	8
Conventions Used in This Document.....	8
Logging On.....	9
Logging Off.....	9
PAU or PMU Main Screen.....	10
ICOLU Main Submenu .....	11
ICOLU Menu Bar Selections.....	12
ICOLU Summary Screen .....	13
Performance Submenu.....	14
HDSL Summary Screen.....	15
HDSL 24-Hour History Screen.....	16
HDSL 7-day History Screen .....	17
ISDN Summary Screen.....	18
ISDN 7-Hour History Screen.....	19
Alarms Submenu .....	20
System History Screen .....	21
HDSL History Screen .....	22
ISDN History Screen .....	23

Configuration Submenu .....	24
System Options Screen.....	25
System Alarm Types Screen.....	26
HDSL Alarm Thresholds Screen.....	27
HDSL Alarm Types Screen.....	28
ISDNn Options Screen .....	30
ISDNn Alarm Thresholds Screen .....	31
ISDNn Alarm Types Screen.....	32
Set Factory Defaults Screen .....	33
Test Submenu.....	34
Subscriber Drop Test Screen .....	35
Information Submenu .....	37
Inventory Screen.....	37
Event Log Screen.....	38
Help Screen.....	39
<b>Fault Isolation</b> .....	40
COLU and RT Fault Indicators.....	40
Subscriber Reported Faults .....	42
<b>Product Support</b> .....	Inside back cover



# PRODUCT OVERVIEW

This practice describes the PairGain® PG-Plus® Integrated Central Office Line Unit, PLL-726 List 1, a COLU that provides support for 4 DS0 and 6 DS0 rates on the HDSL link. The ICOLU supports the PG-Plus 6 POTS, 4 POTS, 3 POTS/1 ISDN, 1 POTS/1 ISDN, 2 ISDN, 6 UVG, and 4 UVG Remote Terminals, models respectively PRL-771 List 1B, PRL-770 List 1B, PRL-771 List 1B, PRL-774 List 1B, PRL-773 List 1B, PRL-779 List 1B, and PRL-780 List 1B.

## DESCRIPTION

The ICOLU can support several applications including POTS, UVG, and ISDN. To support the ISDN functions, a PAU or PMU must be installed in the COTS. The ICOLU communicates directly with the PAU or PMU for setup of the ISDN services. Figure 1 illustrates the means of supporting the listed RTs. When operating in the IDLC mode, the RT determines the type of service being supported.

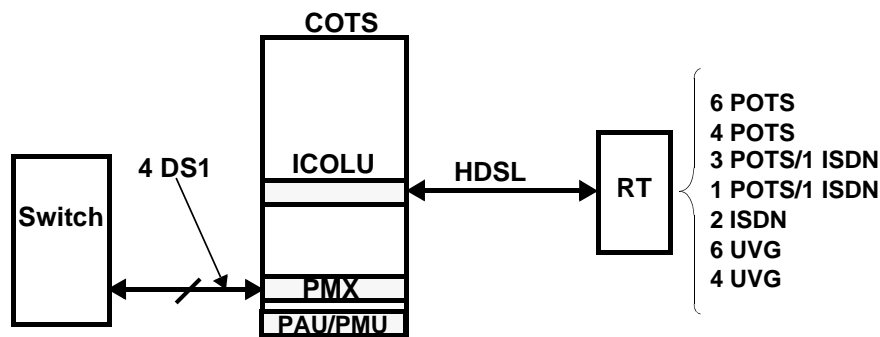

Figure 1. Typical IDLC Configuration

The HDSL interface provides a communication path between the ICOLU and RT. The type of service offered determines whether the operational rate of the HDSL is 4 DS0 or 6 DS0.

The 2 DS0 rate supports the longest distance between the ICOLU and RT. The 6 DS0 rate supports the shortest distance. The PLL-725 supports only the 4 DS0 and 6 DS0 rates. The operating rate is software selectable.

The HDSL interface carries the DS0 and overhead data for the HDSL link and DDS/POTS signalling. The HDSL interface also carries power to the RT eliminating the need for local power. The ICOLU performs echo cancellation, clock and data recovery, and line equalization for the HDSL interface. The ICOLU provides framing for the HDSL link and supports the HDSL data link function.

The POTS interface to the network is a bidirectional two-wire analog voice channel. The RT performs the analog-to-digital and digital-to-analog conversion required to transmit the voice information over a DS0 channel on the HDSL interface. The POTS interface supports all the POTS signalling requirements.

The ICOLU supports an interface to the PAU or PMU in the COTS. A digital interface transfers the ISDN and POTS data through the backplane. The PAU or PMU then multiplexes the data into a DS1 interface. This interface can be used to control and provision the ICOLU, and to send alarm and status information to the PAU or PMU. The ICOLU acts as a slave on this bus.

The ICOLU supports recognition of drop test request signals. The ICOLU supports both MLT and 4TEL drop test initiation signals. The PAU or PMU then places a resistive signature on the test bus to indicate a pass or fail condition.

## SPECIFICATIONS

### System

Resistive Signature                      Tip to Ground 162 K; Ring to Ground 453 K

### Power Supply

Input Voltage                              -42.5 Vdc to -56 Vdc

### HDSL Line

Output Voltage                            ±140 Vdc (maximum)  
 Output Power                             27 W (maximum)  
 HDSL Line Code                         2B1Q  
 HDSL Line Rate                         262 Kb per second (392 Kb per second)  
 HDSL Reach                               15.0 kft, 26 gauge; 21.7 kft, 24 gauge; 49.7 kft, 22 gauge

### Maximum Line Attenuation

4 POTS, 1 POTS/1 ISDN, 4 UVG,  
1 UVG/1 ISDN                            45.9 dB at 65 kHz  
 6 POTS, 3 POTS/1 ISDN, 2 ISDN,  
3 UVG/1 ISDN, 6 UVG                 41.6 dB at 98 kHz

### Environment

Operating Temperature                 -40° F to +150° F; -40° C to +65° C  
 Operating Humidity                      5 to 95 percent (noncondensing)  
 Altitude                                     -200 ft. to 13,000 ft.; -60 m to 4,000 m  
 Vibration                                    NEBS  
 ESD    Per GR-1089-CORE  
 Power and Lightning                    Per GR-1089-CORE  
 Human Safety                             UL 1459 for Restricted Access  
 Emissions Radiation and Immunity   Per GR-1089-CORE for class A equipment

**Connector**                                50 gold-plated card edge fingers

### Dimensions

Height                                       5.5 in., 13.97 cm  
 Width                                        1.1 in., 2.79 cm  
 Depth                                        10.25 in., 26 cm  
 Weight                                       1.0 lbs., 0.45 kg.



## POWER CONSUMPTION AND HEAT DISSIPATION

The three most important power demands of an ICOLU on the COTS power supply are its maximum power consumption, its maximum heat dissipation, and its maximum current drain. [Table 1](#) lists the power consumption and heat dissipation for the ICOLU, on a per slot and per COTS basis.



**The worst case conditions under which these parameters are measured include a 15,000 ft., 26 AWG loop, a fully loaded COTS, and a -42.5 Vdc COTS battery voltage. The RT is assumed to be an OEM with a maximum power consumption of 25 W.**

*Table 1. Power Consumption and Heat Dissipation*

Power	COLU Slot	19-inch COTS	23-inch COTS
<b>Maximum Heat Dissipation</b>			
HDSL Line Power Off	2.9 W	34.8 W	46.4 W
HDSL Line Power On	7.24 W	86.88 W	145.8 W
<b>Maximum Power Consumption</b>			
HDSL Line Power Off	2.9 W	34.8 W	46.4 W
HDSL Line Power On	33.9 W	406.8 W	542.4 W
<b>Maximum Current Drain</b>			
HDSL Line Power Off	73 mA	0.875 A	1.17 A
HDSL Line Power On	735 mA	8.82 A	11.76 A

### Maximum Heat Dissipation

The maximum heat dissipation measures the power converted into heat that is built up within the ICOLU. It contributes to the total heat generated in the space around the ICOLU. It is used to determine the maximum number of fully loaded COTS per bay that will not exceed the maximum allowable power dissipation density in Watts per square foot.

In CO locations, the maximum heat dissipation for open-faced, natural convection-cooled mountings is limited to 134.7 W per square foot per Section 4.1.4 of the NEBS standard *GR-63-CORE*. The footprint of a standard 16 slot, 23-inch COTS is 7.042 square foot. The maximum bay dissipation is therefore limited to 948.5 W. At 115.8 W per COTS, the number of fully loaded COTS is limited to eight per bay with a heat baffle between every COTS.

PairGain recommends that the number of COTS per bay be limited to six, to allow the flexibility to deploy the widest range of PG-Plus services from each COTS.



**This is a worst case situation in that it assumes the entire CO is subjected to the maximum power density. Conditions other than those presented in this practice would permit increasing the number of shelves per bay without jeopardizing the CO thermal integrity. Due to the chimney effect, it is recommended to install one heat-dissipating baffle between every COTS. Otherwise, the rated operating temperature of the COLU units may be exceeded.**

### Thermal Loading Limitations

The thermal loading limitations imposed when using the ICOLU in a CEV or other enclosures are determined by applying the ICOLU power parameters to the manufacturer's requirements for each specific housing.

## Maximum Power Consumption

The maximum power consumption is the total power that the ICOLU consumes or draws from its -48 Vdc COTS power source. This parameter is needed when the ICOLU is located remotely from its serving CO. It determines the battery capacity required to maintain an 8-hour standby battery reserve for emergency situations. It therefore limits the maximum number of line units in a RT.

## Maximum Current Drain

The maximum current drain is the maximum current drawn from the COTS power supply when it is at its minimum voltage (-42.5 Vdc). This determines the COTS fusing requirements.

## MONITORING, HISTORY, AND DIAGNOSTICS

COLUs provide extensive real-time, non-disruptive monitoring of HDSL transmission performance parameters for all units in a circuit. PG-Plus allows user-selectable threshold settings for performance monitoring measurements. Performance of the user interface ports is also monitored. Monitored parameters include:

- HDSL Noise margin, pulse attenuation, ES, UAS
- Interface ES, SES, UAS, BPV seconds
- Major Alarm Relay Form-C relay contacts (NO, NC, C). Fail-safe operation
- Loopbacks Local interface loopback, local HDSL loopback, remote loopback

## Performance Parameters

Based on the monitored parameters, the COLUs derive the following performance parameters:

- HDSL MAR A measure of the ratio of signal power to noise power, in dB, at a receiver point. A 0 dB value means the predicted transmission BER is equal to  $10^{-7}$ , a 6 dB value means the predicted transmission BER is equal to  $10^{-10}$ . The status display continuously updates the margin value.
- HDSL CRC-6 A 6-bit word in every HDSL frame representing a calculation based on the bits in that frame. Any mismatch at the receiver, between the received CRC-6 and the one calculated, based on the received data in the frame, indicates that one or more bits were received in error. The units use this parameter to derive the HDSL ES performance parameter.
- HDSL LOSW ICOLU has detected an error in one or more bits in six consecutive HDSL SYNC words. Two consecutive SYNC words must be received without error to clear this condition. A LOSW condition generally indicates the loop is down, thus data cannot be transmitted. The ICOLU uses this parameter to derive UAS performance parameter.
- HDSL ES An interval of 1 second during which at least one CRC-6 error is detected at the incoming HDSL port, or there is an LOSW condition.
- HDSL UAS An interval of 1 second during which a loop is down.

## Alarms and Alarm Values

The COLUs generate alarms for conditions on the HDSL transmission facility and at the application interface. These alarms can be individually set to the values of Critical, Major, Minor, Not Alarmed, and Not Reported:

- MAR
- ES
- LOSW
- PFO
- PFS
- PGF
- MISMATCH
- NORLUSW
- MISPWRAn
- MISPWRBn

## History

Current cumulative counts of the past 24 hours and historical data in the form of 24-hour history and a 7-day history are available to assist you in identifying problem sources.

- HDSL Interface 24-Hour and 7-Day for ES and UAS
- Alarm Time stamp of first and last occurrence, number of occurrences for all enabled alarms

## LEDs DESCRIPTIONS

Table 2 describes the ICOLU front-panel LEDs in which  $n$  equals the subscriber line. For further details, refer to “Initialization Sequence” on page 7 and the “COLU and RT Fault Indicators” on page 40.

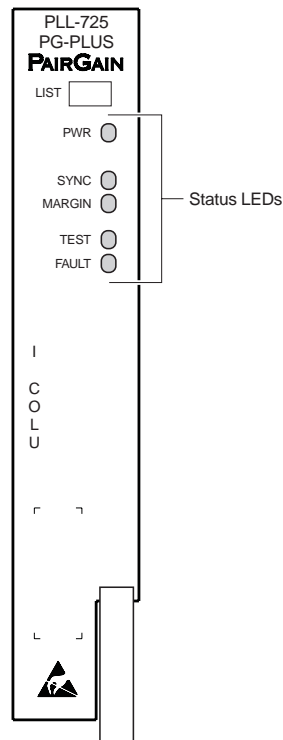

**Figure 2.** LEDs on Front Panel

**Table 2. LEDs Descriptions**

<b>LEDs</b>	<b>Mode</b>	<b>Description</b>	
<b>PWR</b>	Green	On	HDSL line feed is normal
		2 Hz Flash	Problem with the ICOLU power supply or the HDSL line feed is open
		Off	ICOLU is not receiving power or the fuse is blown
<b>SYNC</b>	Green	On	HDSL line is in synchronization between the ICOLU and RT
		Flash	HDSL line is attempting to synchronize with the RT
		Off	Active RT is not detected
<b>MAR</b>	Yellow	On	ICOLU HDSL margin is below a preset level
		2 Hz Flash	RT HDSL margin is below a preset level
		Off	HDSL margin is above a preset level
<b>TEST</b>	Yellow	On	Loopback active
		2 Hz Flash	SDT active
		Off	No tests active
<b>FAULT</b>	Red	On	Fault in the ICOLU (and RT, if RT is in fault at same time)
		Flash	Fault in the RT.
		Off	No faults are detected at the ICOLU or RT

## INSTALLATION AND TEST

The following sections describe the tools and procedure for installing and testing the ICOLU.

### REQUIRED TOOLS AND TEST EQUIPMENT

No tools are required to install the ICOLU. For testing, the following tools may be utilized:

- Telephone test set
- Optional, PSU-795, COTS Continuity Test Card, 150-1695-01 List 1

## INSTALLING THE ICOLU

You can install the ICOLU in any slot except the three positions labeled COMMON, MUX 1, and MUX 2.

- 1 Open the retaining latch on the front of the ICOLU.
- 2 Insert the ICOLU into the card guides in a vacant slot in the COTS that corresponds to the location of the wiring from the CO switch (see [Figure 3](#)). Refer to the cabling tables provided in the COTS documentation for slot and Telco cabling assignment.
- 3 Engage the retaining latch to hold the card in place.

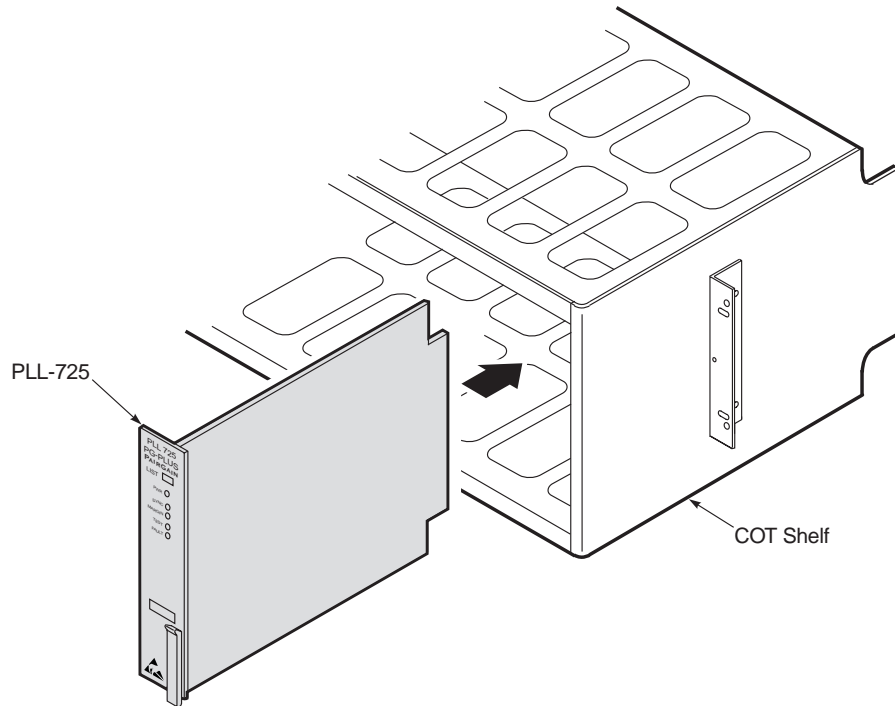

**Figure 3.** Installing the ICOLU into a COTS

## INITIALIZATION SEQUENCE

After inserting the ICOLU into the appropriate slot in the COTS, the following events occur in the order listed:

- All LEDs briefly blink On and then Off, with the exception of the PWR LED, which remains Flashing.
- After about 5 seconds, the ICOLU applies power and goes into start-up mode. If an RT is present and no PFSs, PFOs, or PGFs are detected, the PWR LED is On green. If the line is Offhook, the HDSL power is not applied until it goes Onhook for at least 3 seconds. There is a 5 second delay before turning on the HDSL power.
- After applying the HDSL power, the tests for overload and ground fault conditions are performed. If the HDSL line power is normal, the PWR LED is On steadily and HDSL start-up is initiated.
- As the ICOLU continues with start-up mode, the SYNC LED Flashes, indicating the HDSL line is attempting to acquire synchronization. When synchronization is complete, the SYNC LED is On. On nominal loop lengths, the HDSL synchronization process takes 45 to 60 seconds. If the start-up process fails, the power is recycled at the RT and the start-up process is re-initiated.

- If an overload or ground fault condition is detected before initiating an HDSL start-up, the system goes into the Restart Pending state and waits for 5 minutes, then applies power to the RT and attempts the HDSL synchronization again. This process is repeated until a successful HDSL synchronization is achieved.
- The MARGIN LED is On yellow indicating the ICOLU signal-to-noise ratio is equal to or below the selected signal-to-noise ratio threshold on the ICOLU. The MARGIN LED Flashes if the signal-to-noise ratio of the HDSL line is equal to or below the selected signal-to-noise ratio threshold on the RT.

## SUBSCRIBER DROP TESTS

PG-Plus supports testing of a subscriber drop. You can initiate a test through the VT-100 Terminal connected to the PAU or PMU maintenance port by selecting it from the *Test* menu (see POTS “Subscriber Drop Test Screen” on page 35). The relays in the RT provide a path for performing the SDT.

## ADMINISTRATION

Performance monitoring is built into PG-Plus application. You can access the VT-100 port of the PAU or the PMU to review performance measurements that provide an indication of the quality of transmission to the subscriber. You can perform system administration functions, such as alarm checking and clearing, configuration changes, performance monitoring, and testing for the ICOLU through the screens.

Connect a VT-100 terminal is connected to the RS-232 interface on the front panel of either the PAU or the PMU to access the ICOLU screens. If the system does not respond, verify the following values are present:

- VT-100 terminal Hardware Flow Control is set to On
- XON/XOFF is enabled
- ASYNC parameters: Data = 8, Parity = None, Start/Stop = 1.

For further information on connecting a terminal and accessing the screens refer to the PAU or the PMU Technical Practice.

## CONVENTIONS USED IN THIS DOCUMENT

Some screen shots in this document come from a prototype set-up and may appear slightly different from what you see on your Craft interface screen. The basic information and contents should be similar. This document uses the following conventions for menus and shortcuts.

<b>Example</b>	<b>Describes</b>
<i>menu</i>	name of menu item
<i>submenu</i>	name of submenu item
<b>prompts</b>	the place where you answer yes or no or some other response required
<b>error</b>	the name of what's wrong
error text	an explanation of what's wrong
xxxx	a variable, such as POTS unit 1 in a 6 POTS unit

## LOGGING ON

- 1 Press **SPACEBAR** several times to activate the Autobaud feature. Supported baud rates are 1200, 2400, 4800, 9600, and 38400. The Logon Password screen displays.

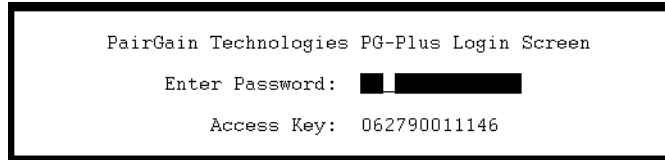

- 2 Type the default password and press **ENTER** to view the PAU or PMU Main menu bar.

Select the ICOLU you want to view. The screens presented to the VT-100 terminal are generated by the ICOLU. For further information on connecting a terminal and accessing the screens refer to the PAU or PMU Technical Practice.



**The factory-default password is password#1. If you establish a different password, you must type the new password at a subsequent log on.**

**Passwords are not case sensitive. The password must use at least 6 and no more than 10 characters, and MUST contain at least 1 alpha, 1 numeric, and 1 special character.**

**The factory defaults in this document are standard factory defaults. You may have a customized version of the product, in which case, refer to the PG-Plus Customized Factory Defaults for the values appropriate to the product version you have.**

## LOGGING OFF

If you must leave your VT-100 terminal unattended for any length of time, it is good practice to log out until you are ready to resume work. This prevents unauthorized persons from inadvertently changing any of your operating parameters. Log out by choosing Quit from the menu bar or by disconnecting the cable connecting the console to the PAU or the PMU.

# PAU OR PMU MAIN SCREEN

The first screen displays with the COTS Main menu bar. The screens are identified by the COTS slot number at the top of each screen. The provisionable System ID string displays at the bottom center, the date displays at the lower left of the screen and the time in military format displays at the lower right of the screen.

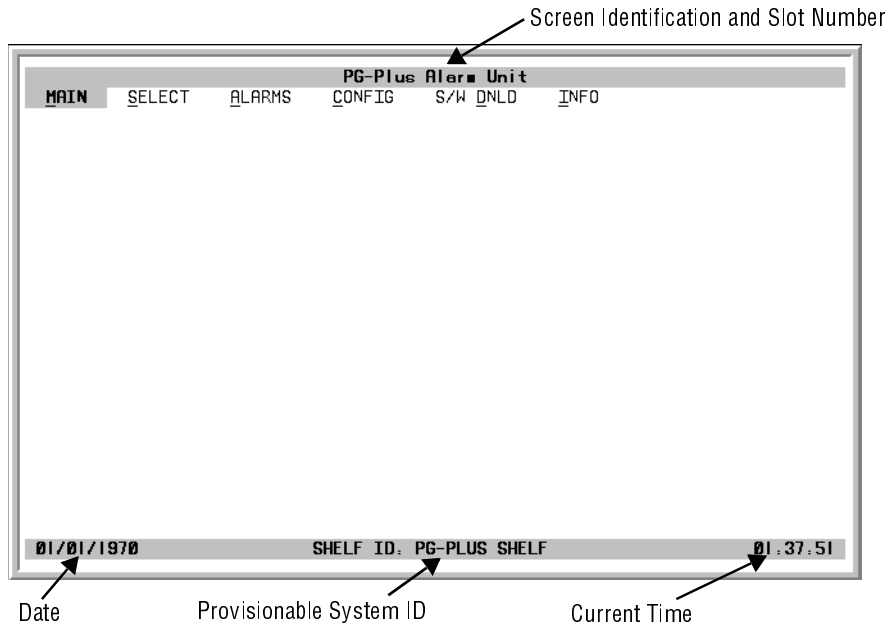

- 1 If you want to access a specific ICOLU but do not know the slot number, press **ENTER** to view the COTS information.
- 2 Note the slot number of the desired ICOLU. There may be more than one of the COLU type you are installing.

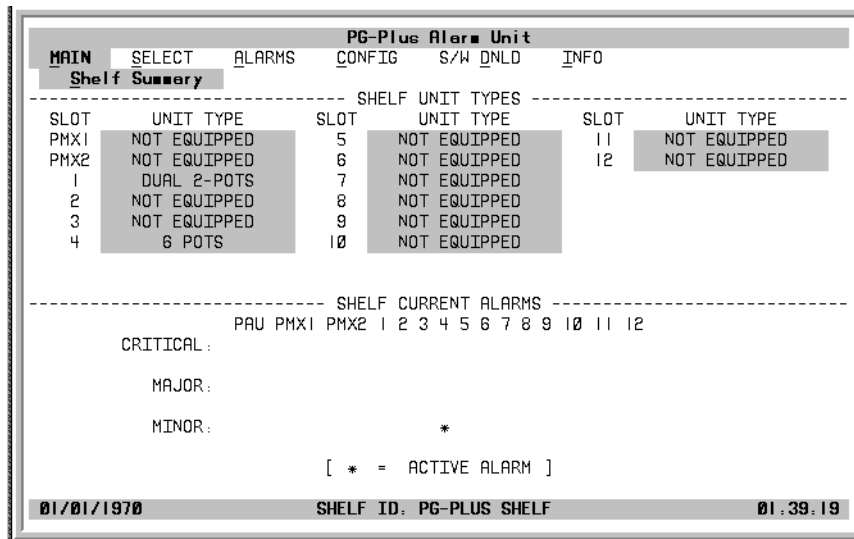

- 3 Press **ESC** to return to the Main menu bar.
- 4 Scroll to the *Select* option and press **ENTER** to access the submenu.
- 5 Scroll to the slot number noted above and press **ENTER**.



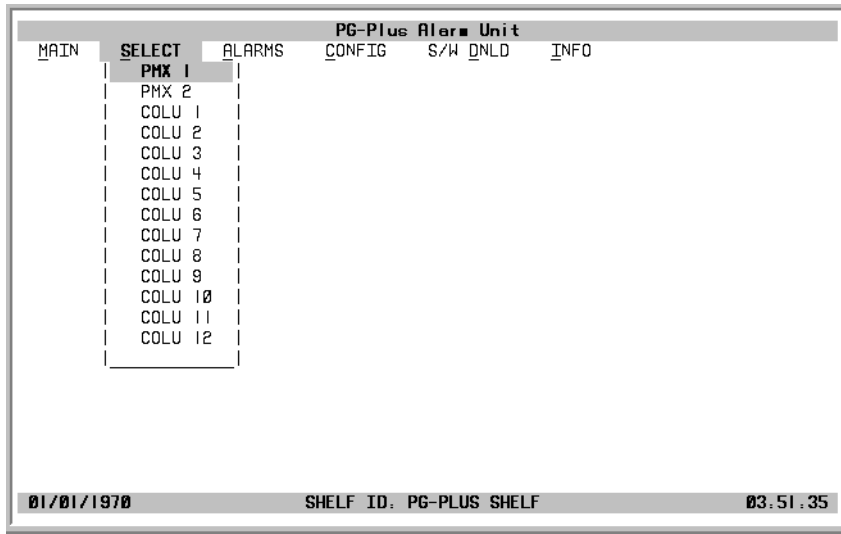

## ICOLU MAIN SUBMENU

When you select the ICOLU from the PAU/PMU *Select* menu option, the Main screen displays. You can perform any of the functions in [Table 3](#) from this screen. These following submenus and screens are set-up dependent. If you are using the ICOLU to support a 3 POTS/1 ISDN RT then only those submenu choices and screens are displayed. The following screens and submenus show a setup in which both POTS and ISDN are installed. You can view and interact with any screens needed by the ICOLU-to-RT set up that you have installed.

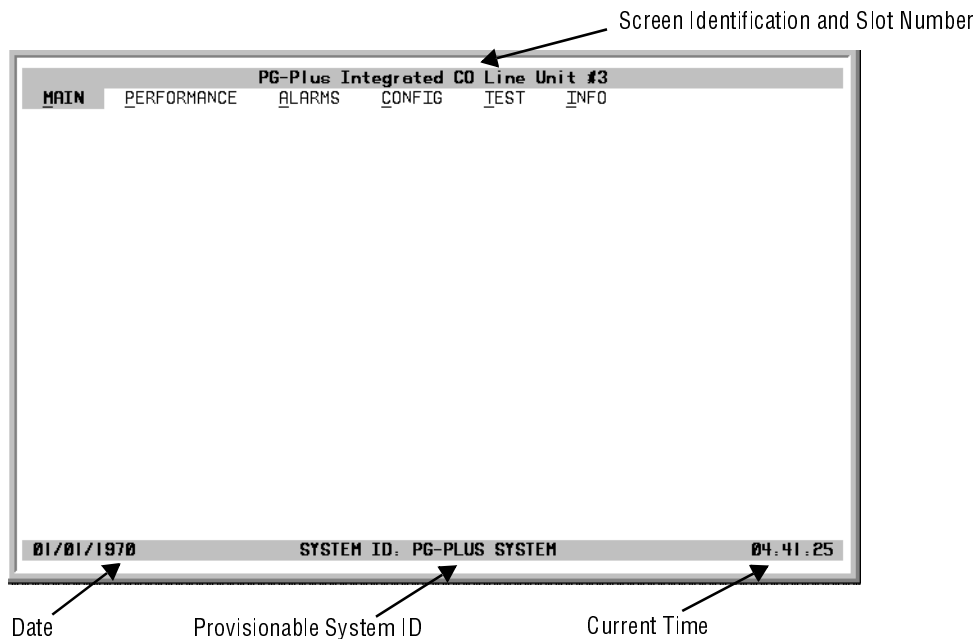

At the CONFIG submenu you will see screens for all the supported RT types. These screens allow you to configure the ICOLU for a different type RT while still connected to another. An example would be that you have the ICOLU attached to an all POTS RT and want to switch it to a 2 ISDN RT, then you can configure it prior to the field installation of the 2 ISDN RT. When the 2 ISDN RT is installed and online, other submenu options are available with which you can do fine tuning to the connection, such as setting the alarm thresholds.

## ICOLU Menu Bar Selections

Table 3 describes the menus and submenus selectable from the ICOLU menu bar.

**Table 3. Menu Bar Selections**

Select the underlined alpha character:	To View or Change:
<b><u>M</u>ain</b>	Circuit configuration. Performance summary information. Alarm summary information.
<b><u>P</u>erformance</b>	HDSL Summary and reset the minimum and maximum margin counts. Date and time of the last reset of the minimum and maximum margin counts. Information about the HDSL span, 24-hours of performance history including ES, UAS and validity of counts. History screens. 7-day history plus current day's accumulated performance information including ES, UAS and validity of counts. Signal history on any of the units, and clear the Trace buffer.
<b><u>A</u>larms</b>	HDSL History screen detailing the number of times each alarm occurred, time and date of first and last occurrence, the provisioned notification type, and current status. Alarm history
<b><u>C</u>onfig</b>	Options such as SDT, HDSL Periodic Power Up, and System ID. Alarm types of all System alarms Threshold crossing values for the 24-hour ES count and low margin dB. HDSL and DSL line power alarms. Signalling transmit level at the RT. Operating parameters reset to factory defaults.
<b><u>T</u>est</b>	SDT, includes hazardous voltages, foreign voltages, resistive faults, and CPE termination status.
<b><u>I</u>nto</b>	Registration information to track product manufacturing, configuration, and revision state. Event log Summary of navigational methods

## ICOLU Summary Screen

This screen details the performance condition of the ICOLU and RT.

- 1 Select *Main* from the menu bar and press **ENTER** to view the ICOLU Summary screen.

The screenshot shows the 'PG-Plus Integrated CO Line Unit #1' menu with options: MAIN, PERFORMANCE, ALARMS, CONFIG, TEST, INFO. The 'Channel Status' section shows POTS1 through POTS6 with 'COLU' status. The 'HDSL Status' section shows 'NORMAL' and 'SPAN' with 'RLU' status. The 'PERFORMANCE' section shows 'HDSL Margin (dB) : 20' and 'HDSL ES (24 Hr.) : 0'. The 'ALARMS' section shows 'SYSTEM : NONE' and 'HDSL : NONE'. The footer shows '12/22/1998', 'SYSTEM ID. PG-PLUS SYSTEM', and '22.11.05'.

Annotations on the right side of the screenshot:

- Channel Status and HDSL Status: Status indicators for the HDSL span and the subscriber interfaces
- PERFORMANCE: HDSL performance summary in terms of margin and ES count
- ALARMS: Status of current HDSL and System alarms

- 2 Press **ESC** to move up a menu level, or **CTRL + R** to return to the Main menu. Refer to the Performance and Alarms screens for a detailed description of data displayed in these areas.

**Table 4. System Status**

System Status	Description
<b>Channel Status</b>	Indicates the state of the subscriber line into the ICOLU.
Open	No CO battery detected. The Line Status is Open. This status does not change except for Test status.
Idle	CO battery detected and line is Onhook at RLU
Ringing	Line is ringing
Busy	Line is Offhook at RT
Test	Line is under SDT
N/A	Not available
<b>HDSL Status</b>	Displays a representation of the HDSL link.
HDSL Link Down	HDSL link is down
Start-up	System in start-up mode where the HDSL link is acquiring synchronization (6 DS0 or 4 DS0)
Normal	System running normal where the HDSL link is synchronized and speech and signaling data are flowing between the ICOLU and the RT (6 DS0 or 4 DS0)
<b>ISDN Channels Status</b>	
Active	The ISDN M-channel is set in the customer direction (towards NT1) as well as network direction (towards LT)
Not Active	The ISDN M-channel is reset in the customer direction or network direction or both.

## PERFORMANCE SUBMENU

The Performance submenu provides access to the ICOLU performance screens. Select *Performance* at the menu bar and press **ENTER** to display the submenu.

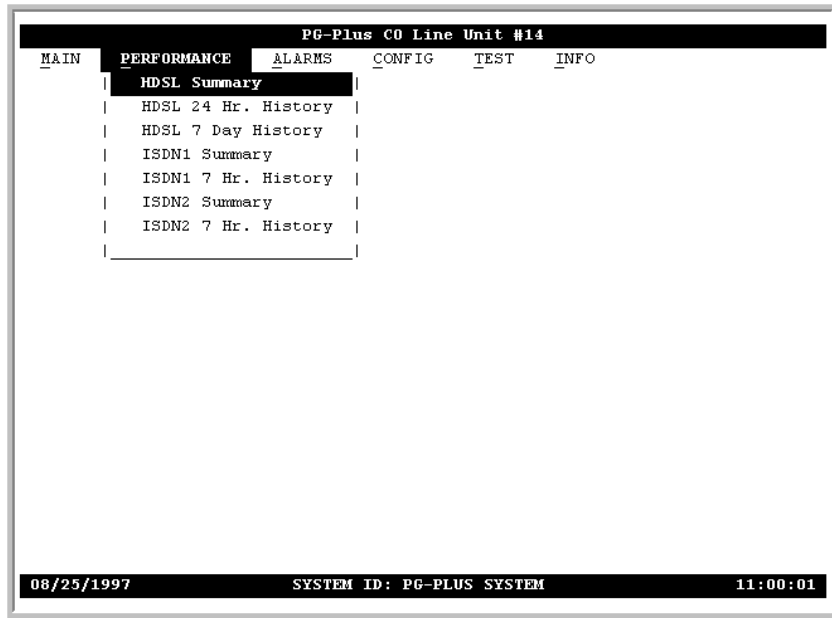

## HDSL Summary Screen

This screen depicts an HDSL performance summary in terms of the margin and ES count.

- 1 Select *Performance* and press **ENTER** to display the submenu.
- 2 Scroll to the *HDSL Summary* option and press **ENTER** to view the screen.

PG-Plus Integrated CO Line Unit #3					
MAIN	PERFORMANCE	ALARMS	CONFIG	TEST	INFO
HDSL Summary					
			COLU	RLU	
Current Margin (dB)	:	N/A	N/A		
Minimum Margin (dB)	:	N/A	N/A		
Maximum Margin (dB)	:	N/A	N/A		
Errored Seconds (24 Hr.)(ES)	:	0	0		
Unavailable Seconds (24 Hr.)(UAS)	:	0	0		
Insertion Loss (dB)	:	N/A	N/A		
HDSL Tip/Ring Reversal (YES/NO)	:	N/A			
RESET MIN/MAX MARGIN COUNTS (Y)?					
MIN/MAX MARGIN COUNTS LAST RESET: --/--/----					---:--:--
01/01/1970		SYSTEM ID: PG-PLUS SYSTEM		04:43:02	

- 3 You can reset the minimum and maximum margins to the current margin values for the ICOLU or RT. Type **Y** at the Reset MIN/MAX Margin Counts prompt to reset the values. If the MAR value falls below or exceeds the value set here, then alarms are registered at the criticality level selected at the “[HDSL Alarm Types Screen](#)” on page 28 and displayed at the “[ICOLU Summary Screen](#)” on page 13.

The date and time of the last reset of the minimum and maximum margin values display at the bottom of the screen.

- 4 Press **ESC** to move up a menu level, or **CTRL + R** to return to the PAU/PMU Main menu.

## HDSL 24-Hour History Screen

This screen shows twenty-four hours of HDSL performance history. The performance history data displayed includes ES and UAS counts, and the validity of the counts for the ICOLU and the RT.

- 1 Select *Performance* from the menu bar and press **ENTER** to display the submenu.
- 2 Scroll to the *HDSL 24 Hr. History* option and press **ENTER** to view the screen:

PG-Plus Integrated CO Line Unit #3					
MAIN	PERFORMANCE	ALARMS	CONFIG	TEST	INFO
HDSL 24 Hr. History					
Time	COLU		RLU		
	ES	UAS	ES	UAS	
04:30	0-ADJ	0-ADJ	0-ADJ	0-ADJ	
04:15	0-ADJ	0-ADJ	0-ADJ	0-ADJ	
04:00	0-ADJ	0-ADJ	0-ADJ	0-ADJ	
03:45	0-UNA	0-UNA	0-UNA	0-UNA	
03:30	0-UNA	0-UNA	0-UNA	0-UNA	
03:15	0-UNA	0-UNA	0-UNA	0-UNA	
03:00	0-UNA	0-UNA	0-UNA	0-UNA	
02:45	0-UNA	0-UNA	0-UNA	0-UNA	
02:30	0-UNA	0-UNA	0-UNA	0-UNA	
02:15	0-UNA	0-UNA	0-UNA	0-UNA	

COM = Complete, PAR = Partial, ADJ = Adjusted, UNA = Unavailable

PAGE HISTORY BACKWARD	PAGE HISTORY FORWARD	CLEAR HISTORY
-----------------------	----------------------	---------------

01/01/1970      SYSTEM ID: PG-PLUS SYSTEM      04:43:33

In the Time field, the current 15-minute interval information shows the real-time updates. For example, the time interval marked 4:00 contains the information for 4:00 am to 4:15 am. The ICOLU derives the ICOLU and RT performance parameters, which have the valid field values of:

- Unavailable: The system has not run long enough to fill this register.
- Partial: Data is being collected for this register.
- Complete: Data is saved in the history register for the complete interval.
- Adjusted: The time or date has been changed on the system during the interval.

- 3 Highlight either of the paging buttons and press **ENTER** to scroll through all ninety-six 15-minute intervals.
- 4 Highlight the Clear History button and press **ENTER** if you want to clear the history.



**If there is an active alarm associated with the current 15-minute performance history information, this alarm becomes inactive when the 24-hour performance history is cleared.**

- 5 Press **ESC** to move up a menu level, or **CTRL + R** to return to the PAU/PMU Main menu.

## HDSL 7-day History Screen

Shows seven days of performance history plus the current day's accumulated performance information. The information displayed includes ES counts, UAS counts, and the validity of the counts.

- 1 Select *Performance* from the menu bar and press **ENTER** to display the submenu.
- 2 Scroll to the *HDSL 7 Day History* option and press **ENTER** to view the screen:

PG-Plus Integrated CO Line Unit #3					
MAIN	PERFORMANCE	ALARMS	CONFIG	TEST	INFO
HDSL 7 Day History					
COLU			RLU		
Date	ES	UAS	ES	UAS	
01/01	0-ADJ	0-ADJ	0-ADJ	0-ADJ	
12/31	0-UNA	0-UNA	0-UNA	0-UNA	
12/30	0-UNA	0-UNA	0-UNA	0-UNA	
12/29	0-UNA	0-UNA	0-UNA	0-UNA	
12/28	0-UNA	0-UNA	0-UNA	0-UNA	
12/27	0-UNA	0-UNA	0-UNA	0-UNA	
12/26	0-UNA	0-UNA	0-UNA	0-UNA	
12/25	0-UNA	0-UNA	0-UNA	0-UNA	

COM = Complete, PAR = Partial, ADJ = Adjusted, UNA = Unavailable

CLEAR HDSL 7 DAY HISTORY (Y)?

01/01/1970      SYSTEM ID: PG-PLUS SYSTEM      04:44:20

The current day performance information shows real-time updates. At midnight of every day, the current day performance information is moved into the previous day slot and the current day performance information is cleared. The ICOLU derives the performance parameters for both the ICOLU and the selected RT with the valid field values of Unavailable, Partial, Complete, and Adjusted.

- 3 At the Clear HDSL 7 day History prompt, type **Y** if you want to clear the 7-day history information.



**Clearing the 7-day performance history does not clear the current day performance information. The current day performance information may only be cleared through the HDSL 24-hour performance history screen.**

**If there is an active alarm associated with the current 24-hour performance history information, this alarm becomes inactive when the 24-hour performance history is cleared.**

- 4 Press **ESC** to move up a menu level, or **CTRL + R** to return to the PAU/PMU Main menu.

## ISDN Summary Screen

Shows all of the stored ISDN performance data for the COLU and the RT.

- 1 Select *Performance* from the menu bar and press **ENTER** to display the submenu.
- 2 Scroll to the *ISDNn Summary* option and press **ENTER** to view the screen:

```

PG-Plus Integrated CO Line Unit #1
MAIN  PERFORMANCE  ALARMS  CONFIG  TEST  INFO
ISDN1 Summary

PM TYPE: Interim Path

COLU CURRENT      COLU PREVIOUS      RLU CURRENT      RLU PREVIOUS
Customer/Network  Customer/Network  Customer/Network  Customer/Network
HOURLY ES :      N/A / N/A      N/A / N/A      0 / 0      0 / 0
HOURLY SES :     N/A / N/A     N/A / N/A     0 / 0     0 / 0
HOURLY BE  :     N/A / N/A     N/A / N/A     0 / 0     0 / 0
DAILY ES   :     N/A / N/A     N/A / N/A     0 / 0     0 / 0
DAILY SES  :     N/A / N/A     N/A / N/A     0 / 0     0 / 0

CLEAR ISDN1 CURRENT COUNTS (Y)? █
ISDN1 CURRENT COUNTS LAST CLEARED:  --/--/----  --:--:--

01/06/1999      SYSTEM ID: PG-PLUS SYSTEM      14:36:59

```

The displayed information includes:

- ES and SES counts for the current hour, the previous hour, the current day and the previous day
- BE counts for the current hour and previous hour.

Errors in the Customer column indicate errors in transmission from the Network (ISDN switch) to the Customer. Errors in the Network column indicate errors in transmission from the Customer to the Network (ISDN switch).

- 3 You have the option to reset all the data to zero. To do so, at the prompt, type **Y** and press **ENTER**. The date and time the ISDN information was last cleared is displayed at the screen bottom. The PM counts are updated every fifteen seconds.



**Clearing the current ISDN performance data clears the performance counts for the COLU and the RLU. If there are alarms associated with the performance counts at the COLU and RT, those alarms are reset when the ISDN performance data is cleared.**

- 4 Press **ESC** to move up a menu level, or **CTRL + R** to return to the PAU/PMU Main menu.



## ISDN 7-Hour History Screen

Displays the 7-hour ISDN ES history information for the COLU and the RT. The ES counts for the current hour and the previous hour are also displayed for completeness. This means that the 7-hour history begins with the hour prior to the previous hour. The PM counts are updated every 15 seconds.

- 1 Select *Performance* from the menu bar and press **ENTER** to display the submenu.
- 2 Scroll to the *ISDN 7-Hr. History* option, then press **ENTER** to view the screen:

PG-Plus CO Line Unit #13					
MAIN	PERFORMANCE	ALARMS	CONFIG	TEST	INFO
ISDN1 7 Hr. History					
ISDN1 Hourly ES History					
		COLU		RLU	
		Customer/Network		Customer/Network	
Current Hour :		0 /	0	0 /	0
Previous Hour :		0 /	0	0 /	0
Previous Hour-1 :		0 /	0	0 /	0
Previous Hour-2 :		0 /	0	0 /	0
Previous Hour-3 :		0 /	0	0 /	0
Previous Hour-4 :		0 /	0	0 /	0
Previous Hour-5 :		0 /	0	0 /	0
Previous Hour-6 :		0 /	0	0 /	0
Previous Hour-7 :		0 /	0	0 /	0

08/25/1997      SYSTEM ID: PG-PLUS SYSTEM      10:40:41

Errors appearing in the Customer column indicate errors in transmission from the Network (ISDN switch) to the Customer. Errors in the Network column indicate errors in transmission from the Customer to the Network (ISDN switch).

- 3 Press **ESC** to move up a menu level, or **CTRL + R** to return to the PAU/PMU Main menu.

## ALARMS SUBMENU

The ICOLU detects and reports HDSL, POTS, and System related alarmed events to the PAU. Only events provisioned for Critical, Major, or Minor notification types are reported. Select *Alarms* at the menu bar and press **ENTER** to display the submenu.

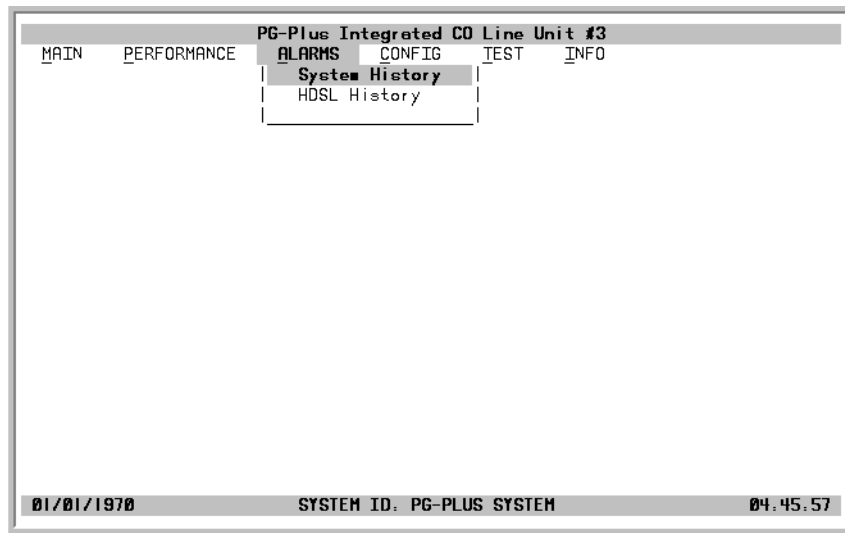

## System History Screen

Shows the system alarm history. Abbreviations for active alarms are listed. If no alarms are present, the status word OK displays. At this screen you can view the results of the alarms set at the Configuration “System Alarm Types Screen” on page 26.

- 1 Select *Alarms* from the menu bar and press **ENTER** to display the submenu.
- 2 Scroll to the *System History* option and press **ENTER** to view the screen. The current information shows real-time updates.

PG-Plus Integrated CO Line Unit #3							
MAIN	PERFORMANCE	ALARMS	CONFIG	TEST	INFO		
System History							
ALARMS		TYPE	CURRENT	COUNT	FIRST	LAST	
Power A Missing	(MISPWRA)	NA	OK	0	--/-- --:--	--/-- --:--	
Power B Missing	(MISPWAB)	NA	OK	0	--/-- --:--	--/-- --:--	
COLU-RLU Mismatch	(MISMATCH)	MN	OK	0	--/-- --:--	--/-- --:--	
No RLU S/W	(NORLUSW)	MN	OK	0	--/-- --:--	--/-- --:--	
PMX Parity Error	(PARITYERR)	MN	OK	0	--/-- --:--	--/-- --:--	
EEPROM Failure	(BKUPMEMP)	MN	OK	0	--/-- --:--	--/-- --:--	
CLEAR SYSTEM ALARM HISTORY (Y)?							
SYSTEM ALARM HISTORY LAST CLEARED: --/--/---- --:--:--							
01/01/1970		SYSTEM ID: PG-PLUS SYSTEM				04:46:37	

- 3 At the Clear System Alarm History prompt, type **Y** if you want to clear the history information. At midnight of every day, the current information is moved into the previous day slot and the current system alarm history information is cleared.
- 4 Press **ESC** to move up a menu level, or **CTRL + R** to return to the PAU/PMU Main menu



**Clearing the system alarm history does not clear the current alarms.**

## HDSL History Screen

The HDSL history maintained on the ICOLU contains a count of the number of times each alarm occurred, the time and date of the first and last occurrence, the provisioned notification type, and the current status. At this screen you view the results of the alarms set at the Configuration “HDSL Alarm Types Screen” on page 28. If no alarms are present, the status word OK displays.

- 1 Select *Alarms* from the menu and press **ENTER** to display the submenu.
- 2 Scroll to the *HDSL History* option and press **ENTER** to view the screen:

PG-Plus Integrated CO Line Unit #3						
MAIN	PERFORMANCE	ALARMS	CONFIG	TEST	INFO	
HDSL History						
ALARMS	TYPE	CURRENT	COUNT	FIRST	LAST	
COLU HDSL LOSW	MN	OK	0	--/--	--/--	
COLU HDSL ES 15 MIN THRESH	MN	OK	0	--/--	--/--	
COLU HDSL ES 24HR THRESH	MN	OK	0	--/--	--/--	
COLU HDSL UAS 15 MIN THRESH	MN	OK	0	--/--	--/--	
COLU HDSL UAS 24HR THRESH	MN	OK	0	--/--	--/--	
COLU HDSL LOW MARGIN	MN	OK	0	--/--	--/--	
COLU POWER FEED OPEN	MN	SUPPRESSED	1	01/01 04:01	01/01 04:01	
COLU POWER FEED SHORT	MN	OK	0	--/--	--/--	
COLU POWER GROUND FAULT	MN	OK	0	--/--	--/--	
RLU HDSL LOSW	MN	OK	0	--/--	--/--	
RLU HDSL ES 15 MIN THRESH	MN	OK	0	--/--	--/--	
RLU HDSL ES 24HR THRESH	MN	OK	0	--/--	--/--	
RLU HDSL UAS 15 MIN THRESH	MN	OK	0	--/--	--/--	
RLU HDSL UAS 24HR THRESH	MN	OK	0	--/--	--/--	
RLU HDSL LOW MARGIN	MN	OK	0	--/--	--/--	
CLEAR HDSL ALARM HISTORY (Y)?						
HDSL ALARM HISTORY LAST CLEARED: --/--						
01/01/1970		SYSTEM ID: PG-PLUS SYSTEM			04:47:43	

At this screen you see the results of the alarms types set at the Configuration “HDSL Alarm Types Screen” on page 28.

- 3 Type **Y** at the Clear HDSL Alarm History? prompt to clear the information. Clearing the alarm history clears the RT and the ICOLU alarm history. If there is an active alarm, then the count is set to 1 and the value in the Last date and time field is set to the First date and time field.
- 4 Press **ESC** to move up a menu level, or **CTRL + R** to return to the PAU/PMU Main menu.

## ISDN History Screen

The ISDN History has two pages: the first relates to the COLU, and the second relates to the RT. The information includes the alarm name, the provisional alarm type, the current status of the alarm, the number of times the alarm was reported, the date and time of the first report alarm that of the last reported alarm. Here you see the results of the alarms set at the Configuration “ISDNn Alarm Types Screen” on page 32.

- 1 Select *Alarms* from the menu and press **ENTER** to display the submenu.
- 2 Scroll to the *ISDNn History* option and press **ENTER** to view the screen:

PG-Plus CO Line Unit #14						
MAIN	PERFORMANCE	ALARMS	CONFIG	TEST	INFO	
ISDN1 History						
COLU ALARMS		TYPE	CURRENT	COUNT	FIRST	LAST
LOSS OF SYNC WORD		MN	OK	0	--/-- --:--	--/-- --:--
LOSS OF SIGNAL		MN	ACTIVE	2	01/01 00:00	08/13 09:16
ES HOURLY THRESH (CUST)		MN	OK	0	--/-- --:--	--/-- --:--
ES DAILY THRESH (CUST)		MN	OK	0	--/-- --:--	--/-- --:--
SES HOURLY THRESH (CUST)		MN	OK	0	--/-- --:--	--/-- --:--
SES DAILY THRESH (CUST)		MN	OK	0	--/-- --:--	--/-- --:--
ES HOURLY THRESH (NTWK)		MN	OK	0	--/-- --:--	--/-- --:--
ES DAILY THRESH (NTWK)		MN	OK	0	--/-- --:--	--/-- --:--
SES HOURLY THRESH (NTWK)		MN	OK	0	--/-- --:--	--/-- --:--
SES DAILY THRESH (NTWK)		MN	OK	0	--/-- --:--	--/-- --:--
DATA TRANSPARENCY LOST		MN	OK	0	--/-- --:--	--/-- --:--
D+ LOSS OF SYNC WORD		MN	OK	1	01/01 00:00	01/01 00:00
DISPLAY RLU ISDN1 ALARM HISTORY				CLEAR ISDN1 ALARM HISTORY		
ISDN1 ALARM HISTORY LAST CLEARED: --/--/---- --:--:--						
08/25/1997		SYSTEM ID: PG-PLUS SYSTEM			11:04:01	

- 3 Use the Display RLU ISDN Alarm History button at the bottom to scroll through other pages of the history.
- 4 Use the Clear ISDN Alarm History button at the bottom to clear the history information..



**Clearing the alarm history clears the RLU and the COLU alarm history, regardless of whether you clear it from the COLU or the RLU page of the history screen. If there is an active alarm, then the count will be set to 1 and the value in the Last date and time field will be set to the First date and time field. If an alarm is not active when you clear the history, the count is reset to 0 and the time stamps for the first and last alarms are cleared.**

- 5 Press **ESC** to move up a menu level, or **CTRL + R** to return to the PAU/PMU Main menu.

## CONFIGURATION SUBMENU

Provides access to system provisioning screens, and an easy means of resetting all options to factory defaults. Select *Config* at the menu bar and press **ENTER** to display the submenu.

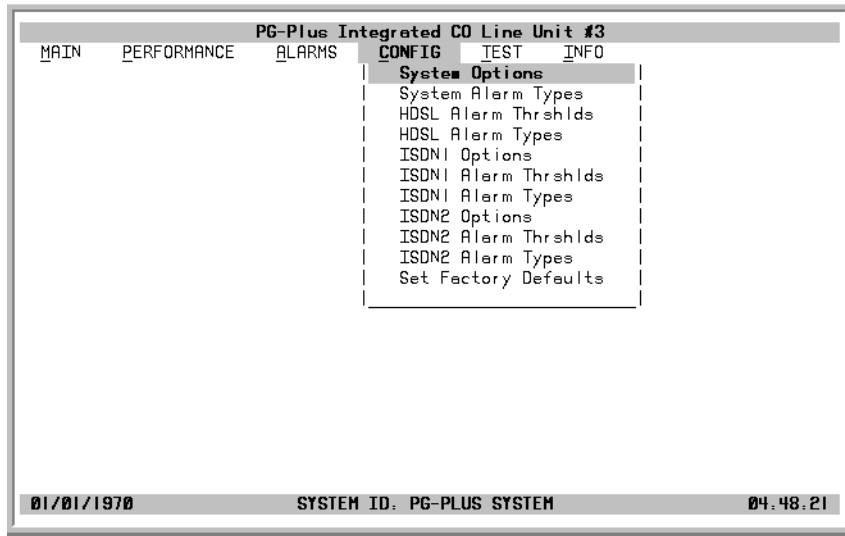

## System Options Screen

System Options screen allows the provisioning of options such as ringing frequency, SDT, HDSL Periodic Power Up, and a System ID. Table 5 shows the configured system option and the factory default value.

- 1 Select *CONFIG* from the menu and press **ENTER** to display the submenu.
- 2 Scroll to the *System Options* option and press **ENTER** to view the screen:

- 3 Highlight the desired field and press **SPACEBAR** to toggle to the desired value, or **TAB** to the next option.
- 4 Press **TAB** to move to the Accept System Option Changes button, and press **ENTER** to accept the changes.
- 5 Press **ESC** to move up a menu level, or **CTRL +R** to return to the PAU/PMU Main menu

**Table 5.** System Options Configuration Fields

Options	Description	Default
POTS Ringing Frequency	The ringing frequency sent from the RT to the subscriber. Possible values include 20 HZ, 25 HZ, 30 HZ, and 50 HZ.	20 Hz
SDT Compatibility	Specifies whether the PG-Plus initiates and operates with MLT or 4TEL loop test systems. Select the test type according to the loop testing system in use. Possible values include Off, MLT, and 4TEL. Craft initiated SDTs work in any selection.	Off
HDSL Periodic Power Up	When ENABLED, PG-Plus attempts to power up the HDSL line every 5 minutes or anytime the HDSL pair is shorted for two seconds and then opened. Setting to DISABLED inhibits the power up sequence under any circumstances.	Enabled
PG-Plus System ID	Configurable identification string for system. There are no special rules for changing the System ID. Any printable character, including space, is valid. This string can be up to 24 characters. Because the System ID is always visible at every ICOLU screen, it is easy to know which ICOLU screens are displayed.	PG-Plus System

## System Alarm Types Screen

Allows the provisioning of the alarm types of all system alarms. [Table 6](#) shows the System Alarm fields and their default settings. You can view the results of these settings from the “[ICOLU Summary Screen](#)” on page 13.

- 1 Select *CONFIG* from the menu and press **ENTER** to display the submenu.
- 2 Scroll to the *System Alarm Types* option and press **ENTER** to view the screen:

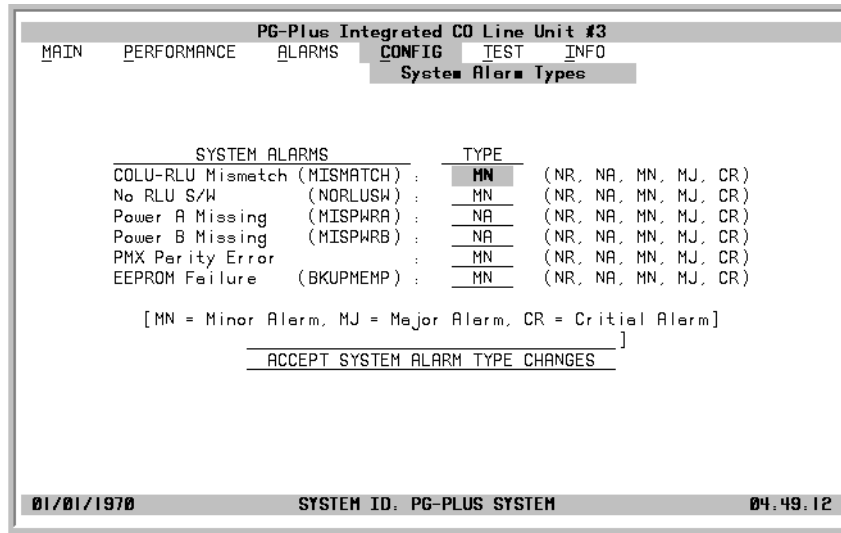

- 3 Highlight the desired field and press **SPACEBAR** to toggle to the desired value, or **TAB** to the next option.
- 4 Press **TAB** to move to the Accept System Alarm Type Changes button, and press **ENTER** to accept the changes.
- 5 Press **ESC** to move up a menu level, or **CTRL + R** to return to the PAU/PMU Main menu

**Table 6.** System Alarm Types Configuration Fields

Alarms	Description	Default
<b>MISMATCH</b>	Incompatible COLU and RT have been installed. For example, the ICOLU has been connected to an subscriber RT.	MN
<b>NORLUSW</b>	RT has no application software and is awaiting software download.	MN
<b>PMX error</b>	PMX parity error	MN
<b>MISPWRA</b>	ICOLU has detected that the A -48 Vdc power source is missing. If power is verified at the ICOLU, then the ICOLU must be replaced, because it has a blown fuse.	NA
<b>MISPWRB</b>	ICOLU has detected that the B -48 Vdc power source is missing. If power is verified at the ICOLU, then the ICOLU must be replaced, because it has a blown fuse.	NA
<b>EEPROM</b>	EPROM failure	MN



## HDSL Alarm Thresholds Screen

This screen is a means to provision the threshold crossing values for the 15 minute and 24-hour ES and UAS counts and low margin dB. [Table 7](#) lists the fields of the HDSL Alarm Thresholds and the default factory values.

- 1 Select *CONFIG* from the menu bar and press **ENTER** to display the submenu.
- 2 Scroll to the *HDSL Alarm Thrshlds* option and press **ENTER** to view the screen:

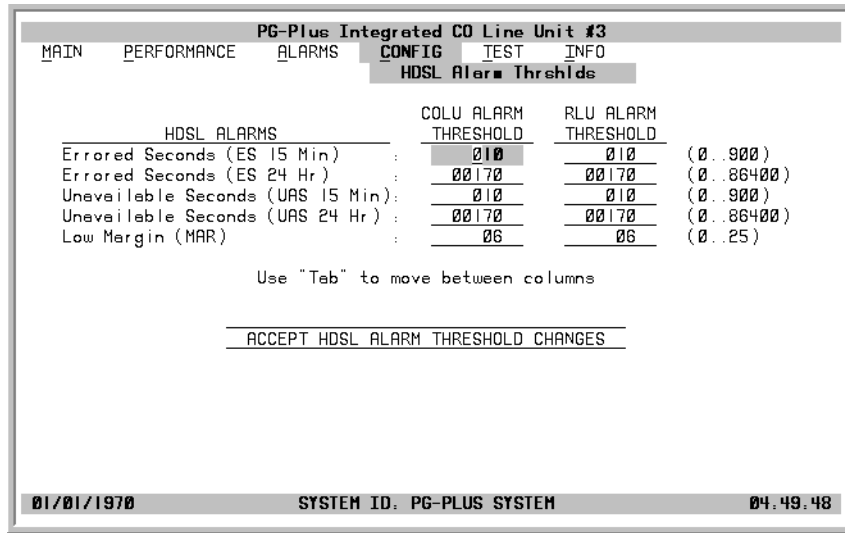

- 3 With the desired field highlighted, press **SPACEBAR** to toggle to the correct value for that field, then **TAB** to the next option.
- 4 When you have completed with the changes, **TAB** to move to the Accept HDSL Alarm Threshold Changes button and press **ENTER** to accept the changes.
- 5 Press **ESC** to move up a menu level, or **CTRL +R** to return to the PAU/PMU Main menu

*Table 7. HDSL Alarm Threshold Fields*

Thresholds	Description	Defaults
ES-15 Min.	HDSL ES alarm is set active if the current 15-minute HDSL ES count reaches or exceeds this threshold.	10
ES (24 hour count)	HDSL ES alarm is set active if ES counts become equal to or greater than this threshold.	170
UAS-15 Min.	HDSL UAS alarm is set active is the current 15-minute HDSL UAS count reaches or exceeds this threshold.	10
UAS-24 Hr.	HDSL UAS alarm is set active if UAS counts become equal to or greater than this threshold.	170
MAR (dB)	HDSL Low Margin alarm is set active if margin drops equal to or less than this threshold.	6

## HDSL Alarm Types Screen

Allows the provisioning of the alarm types for all HDSL Alarms. [Table 8](#) lists the Alarm Reports and [Table 9](#) shows the HDSL Alarms, the possible alarm Types, and the default factory settings. You can view the results of these settings from the “[HDSL History Screen](#)” on page 22.

- 1 Select *CONFIG* from the menu and press **ENTER** to display the submenu.
- 2 Scroll to the *HDSL Alarm Types* option and press **ENTER** to view the screen:

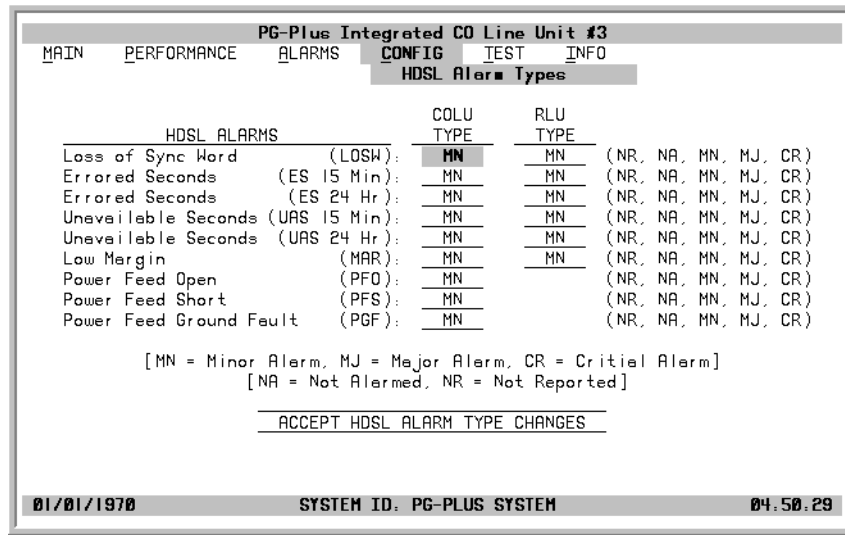

- 3 At the LOSW field in the ICOLU Type column, press **SPACEBAR** to toggle to the desired value, then **TAB** to the RLU Type column.
- 4 When you have completed the changes, move to the Accept HDSL Alarm Type Changes button, and press **ENTER** to accept the changes.
- 5 Press **ESC** to move up a menu level, or **CTRL + R** to return to the PAU/PMU Main menu.

**Table 8. Alarm Reports**

Settings	PAU/PMU Reports	Fault LED Affected	Main Summary Listing	Alarm History Updated
CR/MJ/MN	Yes	Yes	Yes	Yes
NA	No	No	No	No
NR	No	Yes	Yes	Yes

**Table 9. HDSL Alarms**

<b>Alarm</b>	<b>Description</b>	<b>Default</b>
LOSW	ICOLU cannot receive data over the given HDSL loop. ICOLU and RT cannot synchronize and is out of service.	MN
ES-15 Min	Exceeded the user-configurable threshold to give advance warning that HDSL performance is deteriorating. You can set this threshold from 0-15 ES over a 15-minute period, or disable the alarm completely. 24 hour ES alarm threshold reached or exceeded.	MN
ES-24 Hr	Exceeded the user-configurable threshold to give advance warning that HDSL performance is deteriorating. You can set this threshold from 0-255 ES over a 24-hour period, or disable the alarm completely. 24 hour ES alarm threshold reached or exceeded.	MN
UAS-15 Min	Exceeded the user-configurable threshold to give advance warning that HDSL performance is deteriorating. You can set this threshold from 0-15 UAS over a 15-minute period, or disable the alarm completely. 24 hour UAS alarm threshold reached or exceeded.	MN
UAS-24 Hr	Exceeded the user-configurable threshold to give advance warning that HDSL performance is deteriorating. You can set this threshold from 0-255 UAS over a 24-hour period, or disable the alarm completely. 24 hour UAS alarm threshold reached or exceeded.	MN
HDSL MAR	HDSL noise margin of the loop has fallen below the user-configurable threshold. HDSL margin reaches or drops below the current threshold value.	MN
PFO	ICOLU cannot power the RT due to an open circuit. An undercurrent condition as detected by the RT exists for the given pair (<20 mA). A possible cause is that there is no RT at the other end of the circuit. No user intervention is required.	MN
PFS	ICOLU cannot power the RT due to a short circuit. An excessive current condition as detected by the ICOLU exists for either pair (>50 mA). A PFS alarm indicates an overcurrent condition due to wire shorting or an RT failure. The ICOLU automatically turns off power feeding to both loops in response to a PFO or PFS condition on a single loop. No user intervention is required.	MN
PGF	ICOLU cannot power the RLU due to a ground fault.	MN

## ISDNn Options Screen

Allows the provisioning of ISDNn options: Sealing Current, EOC Mode, and RT SES Count. Table 10 shows the configured system option and the factory default value.

- 1 Select *CONFIG* from the menu and press **ENTER** to display the submenu.
- 2 Scroll to the *ISDNn Options* line and press **ENTER** to view the screen:

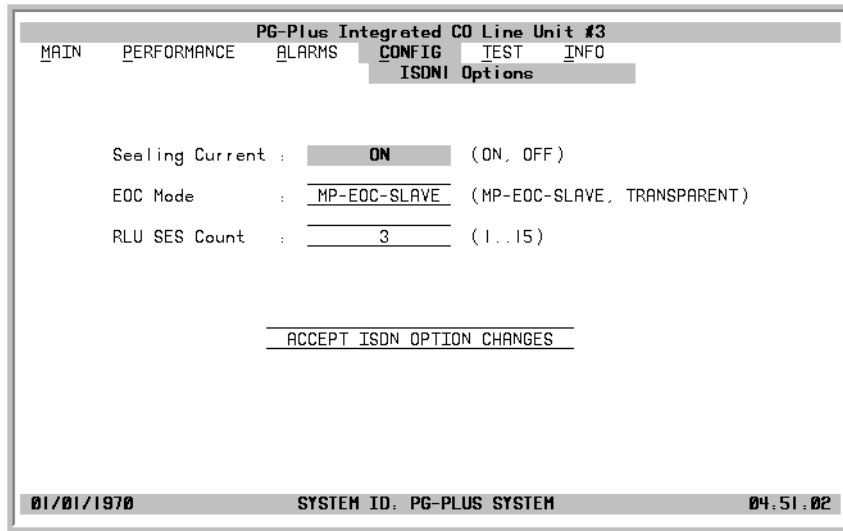

- 3 Highlight the Sealing Current line, press **SPACEBAR** to toggle to the desired value, then **TAB** to the next field to be edited.
- 4 When you have completed the changes, press a directional key to move to the Accept ISDNn Option Changes button, and press **ENTER** to accept the changes.
- 5 Press **ESC** to move up a menu level, or **CTRL + R** to return to the PAU/PMU Main menu.

*Table 10. ISDNn Options*

Alarm	Description	Default
Sealing Current	Sealing Current fields allows the current to be turned On or Off between the RT and the CPE.	ON
EOC Mode	EOC Mode field allows the EOC processing type to be selected.	MP-EOC-Slave
SES	The number of ISDN block errors (BE) allowed before SES count is incremented.	3

## ISDNn Alarm Thresholds Screen

Allows the provisioning of ISDNn alarm thresholds. Table 11 shows the configured system option and the factory default value. The fields on this screen are measured hourly and daily.

- 1 Select *CONFIG* from the menu and press **ENTER** to display the submenu.
- 2 Scroll to the *ISDNn Alarm Thrshlds* option and press **ENTER** to view the screen:

PG-Plus Integrated CO Line Unit #3							
		MAIN	PERFORMANCE	ALARMS	CONFIG	TEST	INFO
ISDN2 Alarm Thrshlds							
ISDN ALARMS			NETWORK END	CUSTOMER END			
RLU Hourly ES Threshold	:		040	040	( 1..255 )		
RLU Daily ES Threshold	:		0100	0100	( 1..4095 )		
RLU Hourly SES Threshold	:		010	010	( 1..127 )		
RLU Daily SES Threshold	:		0025	0025	( 1..2047 )		
ACCEPT ISDN2 ALARM THRESHOLD CHANGES							
		01/01/1970	SYSTEM ID: PG-PLUS SYSTEM			04:54:11	

- 3 Highlight the RLU Hourly ES Threshold line, press **SPACEBAR** to toggle to the desired value, then **TAB** to the next field to be edited.
- 4 When you have completed the changes, press a directional key to move to the Accept ISDNn Alarm Threshold Changes button, and press **ENTER** to accept the changes.
- 5 Press **ESC** to move up a menu level, or **CTRL + R** to return to the PAU/PMU Main menu.

*Table 11. ISDNn Alarm Thresholds*

Threshold	Description	Network End	Customer End
RLU Hourly ES Threshold	An ISDN hourly ES alarm is generated if the accumulated hourly ES count at the COLU/RLU reaches or exceeds this threshold value. A single threshold value is used for thresholding errors in the customer or network direction. The range of values is from 1 to 255. The default value is 40.	40	40
RLU Daily ES Threshold	An ISDN daily ES alarm is generated if the accumulated daily ES count at the COLU/RLU reaches or exceeds this threshold value. A single threshold value is used for thresholding errors in the customer or network direction. The range of values is from 1 to 4095. The default value is 100.	100	100
RLU Hourly SES Threshold	An ISDN hourly SES alarm is generated if the accumulated hourly SES count at the COLU/RLU reaches or exceeds this threshold value. A single threshold value is used for thresholding errors in the customer or network direction. The range of values is from 1 to 127. The default value is 10.	10	10
RLU Daily SES Threshold	An ISDN daily SES alarm is generated if the accumulated daily SES count at the COLU/RLU reaches or exceeds this threshold value. A single threshold value is used for thresholding errors in the customer or network direction. The range of values is from 1 to 2047. The default value is 25.	25	25

## ISDNn Alarm Types Screen

Allows the provisioning of ISDNn alarm types. Table 12 shows the configured system option and the factory default value.

- 1 Select *CONFIG* from the menu and press **ENTER** to display the submenu.
- 2 Scroll to the *ISDNn Alarm Types* option and press **ENTER** to view the screen:

```

PG-Plus Integrated CO Line Unit #3
MAIN  PERFORMANCE  ALARMS  CONFIG  TEST  INFO
                                ISDN1 Alarm Types

                                ISDN ALARMS
                                RLU
                                TYPE
Loss Of Sync Word                (LOSW) :  MN
Loss Of Signal                    (LOS)  :  MN
Customer Hourly Errored Seconds   (ES)   :  MN
Customer Daily Errored Seconds    (ES)   :  MN
Customer Hourly Severely Errored  (SES)  :  MN
Customer Daily Severely Errored   (SES)  :  MN

[MN = Minor Alarm, MJ = Major Alarm, CR = Critical Alarm]
[NA = Not Alarmed, NR = Not Reported]

DISPLAY ISDN ALARM TYPES PAGE 2  ACCEPT ISDN ALARM TYPE CHANGES

01/01/1970                      SYSTEM ID: PG-PLUS SYSTEM                      04:52:19

```

- 3 Highlight the Loss of SYNC Word line, press **SPACEBAR** to toggle to the desired value, then **TAB** to the next field to be edited.
- 4 When you have completed the changes on this page, press the Display ISDN Alarm Types Page 2 button to view the second page of alarms.

```

PG-Plus Integrated CO Line Unit #3
MAIN  PERFORMANCE  ALARMS  CONFIG  TEST  INFO
                                ISDN2 Alarm Types

                                ISDN ALARMS
                                RLU
                                TYPE
Loss Of Sync Word                (LOSW) :  MN
Loss Of Signal                    (LOS)  :  MN
Customer Hourly Errored Seconds   (ES)   :  MN
Customer Daily Errored Seconds    (ES)   :  MN
Customer Hourly Severely Errored  (SES)  :  MN
Customer Daily Severely Errored   (SES)  :  MN

[MN = Minor Alarm, MJ = Major Alarm, CR = Critical Alarm]
[NA = Not Alarmed, NR = Not Reported]

DISPLAY ISDN ALARM TYPES PAGE 2  ACCEPT ISDN ALARM TYPE CHANGES

01/01/1970                      SYSTEM ID: PG-PLUS SYSTEM                      04:55:10

```

- 5 When you have completed the changes, press a directional key to move to the Accept ISDNn Alarm Types Changes button, and press **ENTER** to accept the changes.
- 6 Press **ESC** to move up a menu level, or **CTRL + R** to return to the PAU/PMU Main menu.

**Table 12.** ISDNn Alarm Types

Names	Description	Default
LOSW	ISDN loss of SYNC word condition at COLU and RT.	MN
LOS	ISDN loss of signal condition at COLU and/or RT.	MN
ES	ISDN hourly and/or daily ES count has reached or exceeded the configured value at COLU or RT.	MN
SES	ISDN hourly and/or daily SES count has reached or exceeded the value at the COLU or RT.	MN
DATA-TP-LOST	An unusually high number of bit errors has been detected on the ISDN link at the COLU or RT.	MN
D+-LOSW	ISDN M-channel framing pattern has been lost on the HDSL link.	MN

## Set Factory Defaults Screen

Sets all configuration data back to factory default values.

- 1 Select *CONFIG* from the menu and press **ENTER** to display the submenu.
- 2 Scroll to *Set Factory Defaults* line and press **ENTER** to view the screen:

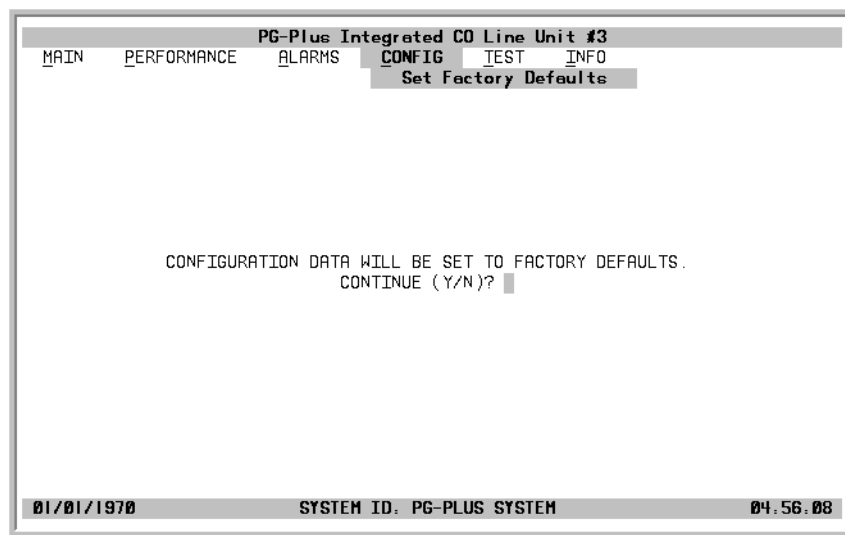

- 3 Type **Y** at the Continue? prompt to reset the system to the Factory Default values, or **N** to maintain the current configuration defaults.
- 4 Press **ESC** to move up a menu level, or **CTRL + R** to return to the PAU/PMU Main menu.

## TEST SUBMENU

Provides access to SDT tests. Select *Test* at the menu bar and press **ENTER** to display the submenu.

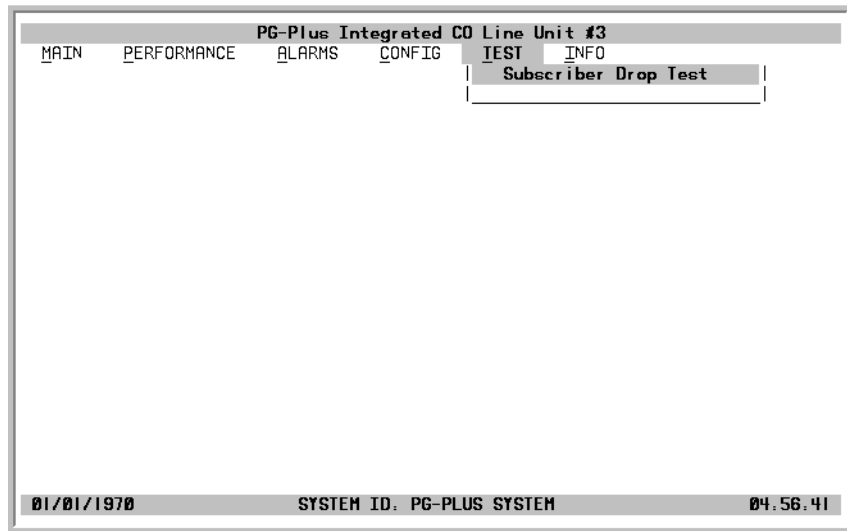



## Subscriber Drop Test Screen

PG-Plus supports testing of a subscriber drop in two ways. A test can be initiated by applying a test voltage between the Tip and Ring at the ICOLU through an MLT test set or by selecting it from the menu item through the VT-100 terminal connected to the PAU Craft port. The relays in the ICOLU and RT provide a path for performing a SDT.

- 1 Scroll to the *Subscriber Drop Test* option and press **ENTER** to view the results of the test:

```

PG-Plus Integrated CO Line Unit #3
MAIN PERFORMANCE ALARMS CONFIG TEST INFO
Subscriber Drop Test

*** RLU type unknown. ***
*** Subscriber Drop Test Disabled. ***

Press <ESC> to return to screens.

01/01/1970 SYSTEM ID: PG-PLUS SYSTEM 04:57:05

```



**Performing a SDT on one of the HDSL channel interrupts service on the line under test. The remaining lines on the PG-Plus system remain in service.**

When the tests are complete, the Drop Tests Results screen displays. The results contains Subscriber Test, Failure Condition, and Test Status. Tests are performed in the order of display. If a test fails, the remaining tests are not performed (as per TR-909). It takes approximately 7 to 8 seconds for all tests to complete.

```

PG-Plus EBS CO Line Unit #1
MAIN PERFORMANCE ALARMS CONFIG TEST INFO

Select circuit to test: EBS1 EBS2 EBS3 EBS4

SUBSCRIBER TEST FAILURE CONDITION TEST STATUS
Hazardous Potential T-G or R-G > 50 Vrms PASSED
T-G or R-G > 135 Vdc

Foreign Voltage T-G or R-G AC volt. > 10 Vrms PASSED
T-G or R-G DC volt. > 6 Vdc

Resistive Fault T-G, R-G, or T-R resist. < 150 Kohms PASSED

EBS CPE Termination Phone Present OR Not Present OR PHONE PRESENT
T-R is Reversed

11/10/1998 SYSTEM ID: PG-PLUS SYSTEM 11:25:38

```

If you have ISDN services supported, then the following screen displays:

```
PG-Plus C0 Line Unit #14
MAIN PERFORMANCE ALARMS CONFIG TEST INFO
Select circuit to test:
  ISDN1  ISDN2

SUBSCRIBER TEST  FAILURE CONDITION  TEST STATUS
Hazardous Potential  T-G or R-G > 50 Vrms  PASSED
                   T-G or R-G > 135 Vdc
Foreign Voltage     T-G or R-G AC volt. > 10 Vrms  PASSED
                   T_G or R-G DC volt. > 6 Vdc
Resistive Fault     T-G, R-G, or T-R resist. < 150 Kohms  PASSED
Network Termination No change in T-R DC resist. with  FAILED
                   a change in applied test voltage.

08/25/1997          SYSTEM ID: PG-PLUS SYSTEM          11:11:29
```

- 2 Press **ESC** to move up a menu level, or **CTRL + R** to return to the PAU/PMU Main menu.

## INFORMATION SUBMENU

Provides technical information about the ICOLU and contact information for PairGain Technologies, Inc.

- 1 Select *INFO* from the menu and press **ENTER** to display the submenu.

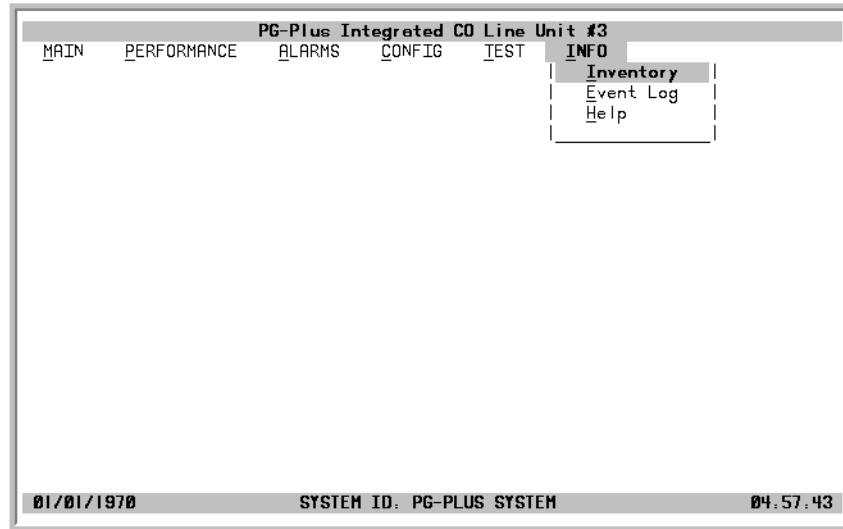

- 2 Select either *Inventory*, *Event Log*, or *Help* to view the associated screen.
- 3 Press **ESC** to move up a menu level, or **CTRL + R** to return to the PAU/PMU Main menu.

## Inventory Screen

Displays all the critical information about the ICOLU and RT. Press **ESC** to move up a menu level, or **CTRL + R** to return to the Main menu.

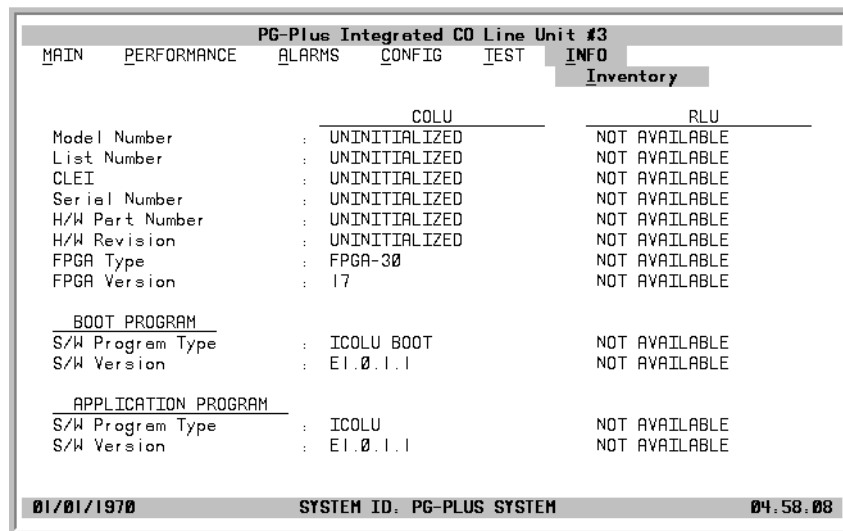

## Event Log Screen

The Event Log screen provides information events that occurred but that are not Alarmed events. The two Events logged are as follows:

- **MEMVER** A provisioning database conversion occurred when a software download occurred. MEMVER is informational only. Event is cleared if you reseal the ICOLU, however it is not required. No customer action is required.
- **MEMCHK** The provisioning factory defaults were restored due to a corrupted database. MEMCHK is informational only. To clear the MEMCHK alarm, at the CONFIG submenu option *Set Factory Defaults*, type Y at the Accept the Set Factory Defaults prompt. No customer action is required.

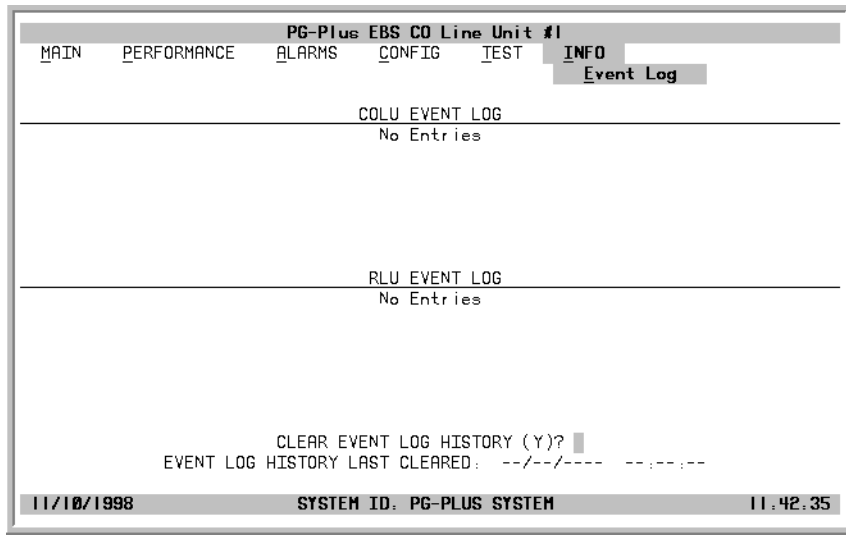

- 1 Type **Y** at the Clear Event Log History? prompt to clear the information. The date and time the Event Log History was last cleared displays.
- 2 Press **ESC** to move up a menu level, or **CTRL + R** to return to the PAU/PMU Main menu.

## Help Screen

Provides information on using the ICOLU screens and menus. The Help screen also lists the PairGain Customer Support and Bulletin Board telephone numbers. Press **ESC** to move up a menu level, or **CTRL + R** to return to the Main menu.

```

PG-Plus Integrated CO Line Unit #3
MAIN PERFORMANCE ALARMS CONFIG TEST INFO Help
Menu Operating Instructions:
Keypress      Effect on Menu      Effect on Screen
ENTER         Moves to submenu or screen  Confirms changes
LEFT ARROW/CTRL-F  Moves LEFT across main menu  Moves the cursor LEFT
RIGHT ARROW/CTRL-G  Moves RIGHT across main menu  Moves the cursor RIGHT
UP ARROW/CTRL-T     Moves UP a submenu           Moves the cursor UP
DOWN ARROW/CTRL-V   Moves DOWN a submenu         Moves the cursor DOWN
SPACE         No effect                  Cycles through choices
ESCAPE       Moves up a menu level       Returns to menus
CTRL-R       Returns to Main Menu        Returns to Main Menu

PairGain 24 Hour Phone Numbers:
Customer Service : 1-800-638-0031
Bulletin Board  : 1-714-730-3299

01/01/1970      SYSTEM ID: PG-PLUS SYSTEM      04:59:10

```

# FAULT ISOLATION

The following sections detail the fault isolation procedures. For sections that indicate a condition such as “distance limitation exceeded”, refer to the section “Specifications” on page 2 for the correct values.

## COLU AND RT FAULT INDICATORS

At the CO, you can use the Craft interface to initiate a SDT to determine the cause of any of the following problems. The SDT test performs Hazardous Potential, Foreign Voltage, Resistive Faults, Receiver Off-Hook, and Ringers Tests. At the customer site, the following sections provide procedures for isolating faults indicated by the COLU LEDs.

- No LEDs On**
- processor in the COLU stopped
    - 1 Remove and re-insert the COLU.
    - 2 At the Craft interface, go to the COLU Main Screen to view the Performance report to verify that no alarms exist. If you cannot view the COLU Main Screen, a communication error exists indicating a faulty COLU.
    - 3 If the LEDs do not illuminate, replace the COLU.
- PWR LED Off**
- no input power
  - on-board fuse is blown on COLU
    - 1 Check input power at COTS backplane with COLU removed.
    - 2 If power is present at COTS backplane, replace the COLU.
- PWR LED Flashing**
- HDSL line open
  - an overload exists
    - 1 Check line continuity and resistance.
    - 2 COLU power supply or the RT may be faulty.
- Fault LED On**
- indicates an existing alarm condition on the COLU (and RT, if RT in Fault state also)
    - 1 At the Craft interface, go to the COLU Main Screen to view the Performance report to determine the cause of the alarm. Correct the condition, if possible. If you cannot view the COLU Main Screen, a communication error exists.
    - 2 Remove and re-insert the COLU.
    - 3 If the communication error still exists, replace the COLU.
- Fault LED Flashing**
- indicates an existing alarm condition on the COLU, RT, or both
    - 1 At the Craft interface, go to the COLU Main Screen to view the Performance report to determine the cause of the alarm. Correct the condition, if possible. If you cannot view the COLU Main Screen, a communication error exists.
    - 2 Remove and re-insert the COLU.
    - 3 If the communication error still exists, replace the COLU.

- 
- Margin LED On**
- distance limitation exceeded
  - fault in HDSL line
  - faulty COLU
- 1 At the Craft interface, go to the COLU Main Screen to view the Performance report to verify that no alarms exist.
  - 2 Initial installation, check engineering records for distance between COTS and RT.
  - 3 If existing installation, measure loss of HDSL line to ensure that the maximum attenuation value has not been exceeded.
  - 4 Replace COLU and/or the RT.
- MARGIN LED Off**
- distance limitation exceeded
  - fault in HDSL line
- 1 Initial installation, check engineering records for distance between COTS and RT.
  - 2 If existing installation, measure loss of HDSL line to ensure that the maximum attenuation value has not been exceeded.
  - 3 Replace COLU and/or the RT.
- SYNC LED Off**
- HDSL line has lost synchronization
  - distance limitation may have been exceeded
  - faulty COLU
- 1 Initial installation, check engineering records for distance between COTS and RT.
  - 2 If existing installation, measure loss of HDSL line to ensure that the maximum attenuation value has not been exceeded.
  - 3 Replace COLU and/or the RT.

## SUBSCRIBER REPORTED FAULTS

At the CO, you can use the Craft interface to initiate a SDT to determine the cause of any of the following problems. The SDT test performs Hazardous Potential, Foreign Voltage, Resistive Faults, Receiver Off-Hook, and Ringers Tests. At the customer site, the following sections provide procedures for isolating faults, based on subscriber reports.

### No dialtone, can not dial

- Short-circuit or open-circuit
- faulty COLU or RT
  - 1 At the CO using the Craft screen, select TEST option, and view the test results. The tests run are for Hazardous Potential, Foreign Voltage, Resistive Fault, and CPE Termination.
  - 2 At the RT, lift the subscriber pair at the RT by opening the RJ-11 connector on the Integrated Protector Module. If dialtone is present at the RT and calls can be placed, the fault is in the subscriber side. Check for shorts or opens towards the subscriber or on the customer premise.
  - 3 If dialtone is not present with the RJ-11 test connector lifted, lift the jumper in the CO between the CO switch and the COTS. If dialtone is present at the switch, replace the COLU.
  - 4 If after replacing the COLU the dialtone is still not present, the fault is in the RT. Replace the RT.

### Phone does not ring

- high-resistance short on subscriber drop (REN load exceeded, see Specification table)
- faulty RT or COLU
  - 1 At the CO, using the Craft interface, go to the COLU Main Screen to verify the correct operation of the COLU. If you cannot view the COLU Main Screen, a communication error exists indicating a faulty COLU. Remove and re-insert the COLU.
  - 2 Go to the Test option, and select the desired circuit to test.
  - 3 View the SDT results. Refer to the Test Submenu section for specific results.
  - 4 At the RT, check for ringing at the RT with the RJ-11 test jack open. If ringing is not present, check for ringing on another line terminated on the same RT. If ringing is present on other lines, check for high-resistance shorts on the subscriber drop. If no high resistance shorts, replace the RT.
  - 5 If ringing is not present on another circuit terminated on the RT, lift the jumper between the CO switch and the COTS. If ringing is present, replace the COLU. If ringing is not present, the fault is in the switch.



**Phone does not  
stop ringing**

- faulty subscriber station instrument
- loop length too long
- faulty RT
  - 1 If phone stops ringing when using a butt-in set at the subscriber location, the subscriber's station internal resistance is too high. Replace phone.
  - 2 If phone does not stop ringing when using a butt-in set at the subscriber location, one or both of these conditions exist:
    - loop length is too long (refer to Specification table)
    - or the RT is faulty.

**Can not hear,  
can not be heard**

- subscriber problem
- faulty COLU or RT
  - 1 Open the RJ-11 test jack at the RT. If audible level is acceptable, the problem is with subscriber equipment.
  - 2 If audible level is too low at the RT with the RJ-11 test jack lifted, lift the jumper in the CO between the CO switch and the COTS.
    - If audible level is acceptable, replace the COLU or RT
    - otherwise, the problem is in the CO switch.



---

# PRODUCT SUPPORT

## TECHNICAL SUPPORT

PairGain Technical Assistance is available 24 hours a day, 7 days a week by contacting PairGain Customer Service Engineering group at:

**Telephone:** (800) 638-0031 or (714) 832-9922

**Fax:** (714) 832-9924

During normal business hours (8:00 AM to 5:00 PM, Pacific Time, Monday through Friday, excluding holidays), technical assistance calls are normally answered directly by a Customer Service Engineer. At other times, a request for technical assistance is handled by an on-duty Customer Service Engineer through a callback process. This process normally results in a callback within 30 minutes of initiating the request.

In addition, PairGain maintains a computer bulletin board system for obtaining current information on PairGain products, product troubleshooting tips and aids, accessing helpful utilities, and for posting requests or questions. This system is available 24 hours a day by calling (714) 730-2800. Transmission speeds up to 28.8 kbps are supported with a character format of 8-N-1.

## WARRANTY

PairGain Technologies warrants this product to be free of defects and to be fully functional for a period of 60 months from the date of original shipment, given correct customer installation and regular maintenance. PairGain will repair or replace any unit without cost during this period if the unit is found to be defective for any reason other than abuse or incorrect use or installation.

Do not try to repair the unit. If it fails, replace it with another unit and return the faulty unit to PairGain for repair. Any modifications of the unit by anyone other than an authorized PairGain representative voids the warranty.

If a unit needs repair, call PairGain for a Return Material Authorization (RMA) number and return the defective unit, freight prepaid, along with a brief description of the problem, to:

PairGain Technologies, Inc.  
14352 Franklin Avenue  
Tustin, CA 92780  
ATTN: Repair and Return Dept.  
(800) 638-0031

PairGain continues to repair faulty modules beyond the warranty program at a nominal charge. Contact your PairGain sales representative for details and pricing.

## FCC COMPLIANCE

This unit complies with the limits for Class A digital devices pursuant to Part 15 of the FCC rules. These limits are designed to provide reasonable protection against harmful interference when the equipment is operated in a commercial environment. This equipment generates, uses, and can radiate radio frequency energy and, if not installed and used in accordance with the instruction manual, can cause harmful interference to radio communications. Operation of this equipment in a residential area is likely to cause harmful interference, in which case the user will be required to correct the interference at his own expense.

Refer to the installation section of the appropriate instruction manual for the unit you are installing to get information on:

- Cabling
- Correct connections
- Grounding

## MODIFICATIONS

The FCC requires the user to be notified that any changes or modifications made to this device that are not expressly approved by PairGain Technologies, Inc. may void the user's authority to operate the equipment.

All wiring external to the products should follow the provisions of the current edition of the National Electrical Code

---

---

**Corporate Office**

14402 Franklin Avenue  
Tustin, CA 92780

Tel: (714) 832-9922

Fax: (714) 832-9924

**For Technical Assistance:**

(800) 638-0031

