

USER MANUAL

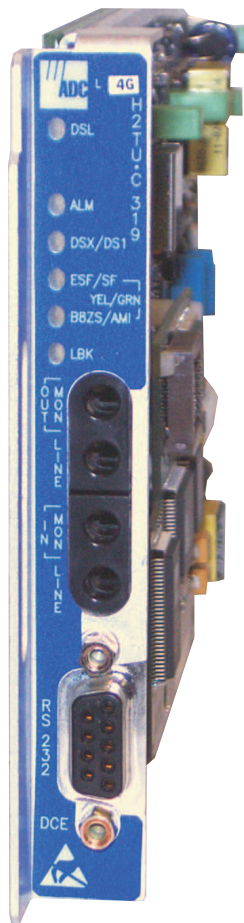

HiGain H2TU-C-319 List 4G Line Unit
Product Catalog: H2TU-C-319-L4G
CLEI: VACKAAAA

Revision History of This Manual

Revision	Release Date	Revisions Made
1	July 31, 2002	Initial release.

Copyright

July 31, 2002

© 2002 ADC DSL Systems, Inc. All rights reserved.

Trademark Information

ADC is a registered trademark of ADC Telecommunications, Inc.

HiGain is a registered trademark of ADC DSL Systems, Inc. No right, license, or interest to such trademarks is granted hereunder, and you agree that no such right, license, or interest shall be asserted by you with respect to such trademark.

Other product names mentioned in this document are used for identification purposes only and may be trademarks or registered trademarks of their respective companies.

Disclaimer of Liability

Information contained in this document is company private to ADC DSL Systems, Inc., and shall not be modified, used, copied, reproduced or disclosed in whole or in part without the written consent of ADC.

Contents herein are current as of the date of publication. ADC reserves the right to change the contents without prior notice. In no event shall ADC be liable for any damages resulting from loss of data, loss of use, or loss of profits, and ADC further disclaims any and all liability for indirect, incidental, special, consequential or other similar damages. This disclaimer of liability applies to all products, publications and services during and after the warranty period.

USING THIS MANUAL

The following conventions are used in this manual:

- Monospace type indicates screen text.
- Keys you press are indicated by small icons such as **Y** or **ENTER**. Key combinations to be pressed simultaneously are indicated with a plus sign as follows: **CTRL** + **ESC**.
- Items you select are in **bold**.
- Three types of messages, identified by icons, appear in text.



Notes contain information about special circumstances.



Cautions indicate the possibility of personal injury or equipment damage.



The Electrostatic Discharge (ESD) symbol indicates that a device or assembly is susceptible to damage from electrostatic discharge.

For a list of abbreviations used in this document, refer to [“Appendix E - Abbreviations”](#) on page 61.

INSPECTING SHIPMENT

Upon receipt of the equipment:

- Unpack each container and inspect the contents for signs of damage. If the equipment has been damaged in transit, immediately report the extent of damage to the transportation company and to ADC DSL Systems, Inc. Order replacement equipment, if necessary.
- Check the packing list to ensure complete and accurate shipment of each listed item. If the shipment is short or irregular, contact ADC DSL Systems, Inc. as described in [“Appendix D - Product Support”](#) on page 60. If you must store the equipment for a prolonged period, store the equipment in its original container.

TABLE OF CONTENTS

Overview	1
Features	1
Applications	2
Front Panel	3
Installation	6
Provisioning	8
Accessing the Provisioning Screens	8
Connecting to a Maintenance Terminal.....	8
Logon Screen	8
Provisioning Tasks	11
Setting Date and Time	11
Setting Circuit ID Numbers	12
Configuring the System	13
Resetting to Factory Defaults	24
Clearing the History, Alarm, and Event Log Screens	25
Monitoring System Activity and Performance	26
Using the Monitor Screen to View System Activity.....	26
Using the Performance Screens to View Performance Data.....	28
Performance History at the DS1 Interface.....	28
Performance History at the HDSL2 Interface	31
Using the Performance Screens to View Alarm Data.....	34
Alarm History at the DS1 Interface	34
Alarm History at the HDSL2 Interface.....	37
Using the System Event Log to Track Events	38
Event Log Messages	39
Origin Tags	40
Using the Report Menu	41
Testing	43
System Alarms	43
Alarm Option for the Digital Loop Carrier Feed.....	44
Remote LOS and AIS Response.....	44
OCT55 Test Pattern with AMI Line Code.....	45
Loopback Operation.....	45
Special Loopback (SPLB) Mode	46
GNLB Mode Loopback Commands.....	46
A3LB Mode Loopback Commands.....	46

Loopback Test Procedures	47
General Troubleshooting Tips	47
Setting the Loopback Time-Out Option.....	47
GNLB Test Procedures	48
A3LB Test Procedures	49
Loopback Testing Using a Maintenance Terminal	50
Loopback Testing Using Remote Unit Front-Panel Pushbuttons	50
Programmable DSX-1 Test Jacks	50
Appendix A - Specifications	53
Power Consumption	54
Maximum Power Dissipation	54
Maximum Current Drain	54
Loop Attenuation.....	55
H2TU-C Card-Edge Connector.....	55
Network Management Control Bus	56
Fuse Alarm.....	56
System Alarm Output Pin	56
Craft Port	57
Appendix B - Functional Operation	58
Timing	58
Ground Fault Detection	58
Appendix C - Compatibility	59
Appendix D - Product Support	60
Appendix E - Abbreviations	61
Certification and Warranty	Inside Back Cover

LIST OF FIGURES

1. H2TU-C Front Panel	3
2. Installing an H2TU-C into a Shelf	6
3. Logon Screen	9
4. Config Menu - Date and Time	11
5. Inventory Screen	12
6. Config Menu	13
7. Config Menu - Standard Options (defaults shown)	14
8. Config Menu - ADC Options (defaults shown)	14
9. Config Menu - Set Factory Defaults	24
10. Config Menu - Master Clear	25
11. Monitor Screen - Active Loopback with Alarms	26
12. H2TU-R DS1 31-Day Performance History	28
13. H2TU-C DS1 48-Hour Performance History	29
14. H2TU-R DS1 25-Hour Performance History	29
15. H2TU-R DS1 Current Statistics	30
16. H2TU-C DS1 Current Statistics	30
17. H2TU-C HDSL2 31-Day Performance History	32
18. H2TU-C HDSL2 48-Hour Performance History	32
19. H2TU-C HDSL2 25-Hour Performance History	33
20. H2TU-C HDSL2 Current Statistics	33
21. H2TU-C DS1 Alarm History Screen	35
22. H2TU-R DS1 Alarm History Screen	35
23. H2TU-C HDSL2 Alarm History Screen	37
24. System Event Log	38
25. Report Menu - Full Report	41
26. H2TU-R LOS and AIS Response Priorities	44
27. Loopback Summary	45
28. Loopback Modes	49
29. DSX-1 Testing Towards Customer	51
30. DSX-1 Testing Towards Network	51
31. Config Menu - DS1 Test Jack	52
32. H2TU-C Card-Edge Connector	55
33. RS-232 Craft Port Pinouts	57
34. H2TU-C Block Diagram	58

LIST OF TABLES

- 1. Front-Panel Description 4
- 2. LED Status and Functions..... 5
- 3. Navigational Keys for the Maintenance Terminal Screens..... 9
- 4. Logon Screen Menus..... 10
- 5. H2TU-C Standard Config Menu Options 15
- 6. H2TU-C ADC Config Menu Options 16
- 7. DS1 and DSX-1 24-Hour PM Threshold 18
- 8. Response to H2TU-R DS1 Frame Conversion Options..... 20
- 9. Extended SuperFrame Format..... 21
- 10. SuperFrame Format..... 21
- 11. DDS NI and DS0 DP Latching Loopback Sequence 22
- 12. HiGain HDSL2 Loopback vs. Latching Sequence 22
- 13. Response of H2TU-C and H2TU-R to LOS and AIS 23
- 14. Monitor Screen Descriptions..... 27
- 15. Error Acronyms Used on the DS1 Performance History Screens..... 31
- 16. Error Acronyms Used on the HDSL2 Performance History Screens 34
- 17. DS1 Alarm Descriptions 36
- 18. HDSL2 Alarm Descriptions 37
- 19. Event Log Entry Messages..... 39
- 20. Origin Tags..... 40
- 21. Report Types 42
- 22. System Alarms Summary..... 43
- 23. Summary of HDSL2 Generic Loopback Codes and Activation Methods 48
- 24. Addressable Repeater Loopback Commands (A3LB)..... 50
- 25. H2TU-C Power Parameters..... 54
- 26. HDSL2 Reach Chart 55

OVERVIEW

The H2TU-C-319 List 4G (H2TU-C) line unit is the Central Office (CO) side of a T1 transmission system. The HiGain HDSL2 product family is fully compliant with the HDSL2 standard ANSI T1.418.

The H2TU-C, when used with an H2TU-R remote unit, transmits a 1.544 Mbps payload on one unconditioned copper pair over the full Carrier Service Area (CSA) range. The CSA includes loops up to 12,000 feet of 24 AWG wire or 9,000 feet of 26 AWG wire, including bridged taps.

The H2TU-C is designed to mount in standard 3192 mechanics shelves. For a list of compatible shelves, see [“Appendix C - Compatibility” on page 59](#).

Enhanced firmware also allows the H2TU-C to be deployed in Wideband 3190 protection switching applications. These applications must meet the following system requirements: HiGain multiplexers (HXU-358s) using software version 1.04 or higher, an H2TU-R-402 remote unit with protection switching support.



The H2TU-C complies with the protection switching features of the PSC-606 List 1 protection switching card. See the PSC-606 List 1 technical practice, document number LTPH-TP-1006-xx for detailed information.

FEATURES

Standard features include:

- HDSL2 transmission features
 - Lightning and power cross-protection on HDSL2 interfaces
 - Full-duplex HDSL2 transmission on one pair at 1.552 Mbps
 - Ultra-low wander (Stratum 1 compliant)
 - Grounded loop detection on High-bit-rate Digital Subscriber Line 2 (HDSL2)
 - Tip and ring reversal detection on HDSL2 loop
 - Sources sealing current when connected to an H2TU-R
- Front-panel features
 - Programmable DSX-1 jacks for intrusive and non-intrusive testing
 - Status Light Emitting Diodes (LEDs)
 - RS-232 craft port for maintenance terminal connection
- Digital Data Service (DDS) latching loopback
- Maintenance screens to provision, monitor, and troubleshoot HDSL2 system
 - DS1 and HDSL2 performance monitoring
 - Loop attenuation and insertion loss reporting
 - Non-volatile storage of performance monitoring parameters
 - Performance Report Messaging (PRM) support for Supplemental PRM (SPRM) and Network PRM (NPRM) at the H2TU-R
 - Payload (PL) and HDSL Generic (HG) loopback source identification

- Margin Alarm (MAL) threshold
- Report menu option for downloading status and performance monitoring data to a file
- Remote provisioning through TL1 FDL
- Fractional T1 (FT1) support
- Configuration options
 - Selectable DSX-1 pre-equalizer
 - Bipolar Violation Transparency (BPVT)
 - Bit Error Rate (BER) alarm
 - Remote provisioning
 - Power Back Off - Customer (PBOC) and Power Back Off - Network (PBON) for configuring power output levels
 - Loss of Signal/Alarm Indication Signal (LOS/AIS) payload alarm
 - Selectable loopback activation codes
- Network Management and Administration (NMA) interface
- Supports automatic protection switching in Wideband 3190 applications



DS1 is used throughout this document to refer to either the remote unit's DS1 interface or the line unit's DSX-1 interface.

APPLICATIONS

HiGain HDSL2 systems provide a cost-effective, easy-to-deploy method for delivering T1 High Capacity Digital Service (HCDS) over a single copper pair. HiGain HDSL2 systems support a multitude of network connections and system models.

- The service is deployed over one unconditioned, non-loaded copper pair.
- Conventional inline DS1 repeaters are no longer required.
- Cable pair conditioning, pair separation and bridged tap removal are not required.

Each loop has no more than 35 dB of insertion loss (INSL) at 196 kHz, with driving and terminating impedances of 135 Ω . In general, HiGain HDSL2 systems:

- Operate effectively in the same cable binder group with other HDSL2 lines, HDSL, T1, ADSL, SDSL, POTS, DDS, and other transmission schemes.
- Can be used with customers requiring DS1 service on a temporary or permanent basis.
- Provide a means of quickly deploying service in advance of fiber-optic transmission systems.

FRONT PANEL

Figure 1 shows the H2TU-C front panel. Table 2 on page 5 describes the front-panel components. For pinout diagrams of the H2TU-C card-edge connector and craft port, refer to “Appendix A - Specifications” on page 53.

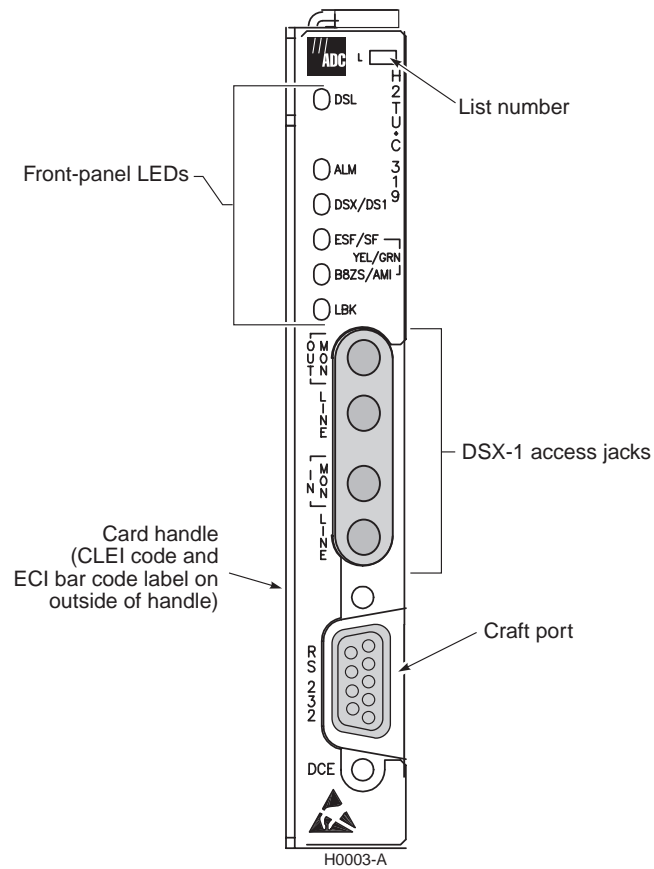

Figure 1. H2TU-C Front Panel

Table 1. *Front-Panel Description*

Front-Panel Feature	Function
List number	Identifies the list number of the H2TU-C.
Front-panel LEDs	Display HDSL2 and DS1 Line, provisioning, and alarm status through front-panel LEDs. Refer to Table 2 on page 5 for a listing of the front-panel LEDs and their functions.
CLEI and ECI bar code label	Provides the human-readable Common Language Equipment Identifier (CLEI) code number and the Equipment Catalog Item (ECI) bar code number.
DSX-1 access jacks	
MON	Provides non-intrusive monitoring jack access to (IN) and from (OUT) the HDSL2 span at the DSX-1 interface. Allows the two DS1 payloads to be monitored. Refer to “ Programmable DSX-1 Test Jacks ” on page 50 for test jack setting information.
LINE	Provides splitting jack access to and from the HDSL2 span or the network based on the DSX-1 Test Jack setting on the Configuration menu. Breaks the OUT and IN paths to permit test signal insertion and retrieval. Refer to “ Programmable DSX-1 Test Jacks ” on page 50 for test jack setting information.
Craft port (RS-232)	Provides bidirectional communication between the unit and an external terminal to allow configuration and performance monitoring through the maintenance terminal screens.
Card handle	Used to insert and extract the H2TU-C from the chassis.

Table 2 lists the LED status and their functions. The H2TU-C reports the alarm type or loopback status on its front panel.

Table 2. LED Status and Functions

LED and Status	Function
DSL	
OFF	No power is applied to the H2TU-C.
Solid green	Normal operation: all HDSL2 spans are synchronized without error.
Solid red	HBER, MARG, or PWRP alarm is present at the H2TU-C.
Flashing red once every second	HDSL2 loop is attempting synchronization.
ALM	
OFF	Normal operation: the DSX-1 signal is present at both the H2TU-R and H2TU-C.
Solid yellow	RLOS is present at the H2TU-R.
Solid red	LLOS is present at the H2TU-C.
DSX/DS1	
Solid green	Normal operation: the DSX-1 signal is error free.
Solid red	LLOS, BPV, frame error, or CRC is present at the H2TU-C.
ESF/SF	
OFF	Unframed DSX-1 is present at the H2TU-C or no DSX-1 is detected at the H2TU-C.
Solid yellow	ESF frame formatting is present at the H2TU-C.
Flashing yellow once every second	ESF frame formatting and frame error/CRC are present at the H2TU-C.
Solid green	SF frame formatting is present at the H2TU-C.
Flashing green once every second	SF frame formatting and frame error are present at the H2TU-C.
B8ZS/AMI	
OFF	No DSX-1 signal is present at the H2TU-C.
Solid yellow	B8ZS is present at the H2TU-C.
Flashing yellow once every second	B8ZS and excess zeros string are present at the H2TU-C.
Solid green	AMI is present at the H2TU-C.
Flashing green once every second	AMI and BPV are present at the H2TU-C.
LBK	
OFF	H2TU-C is not in loopback.
Solid yellow	H2TU-C is in either NLOC or CREM (RLB).

INSTALLATION

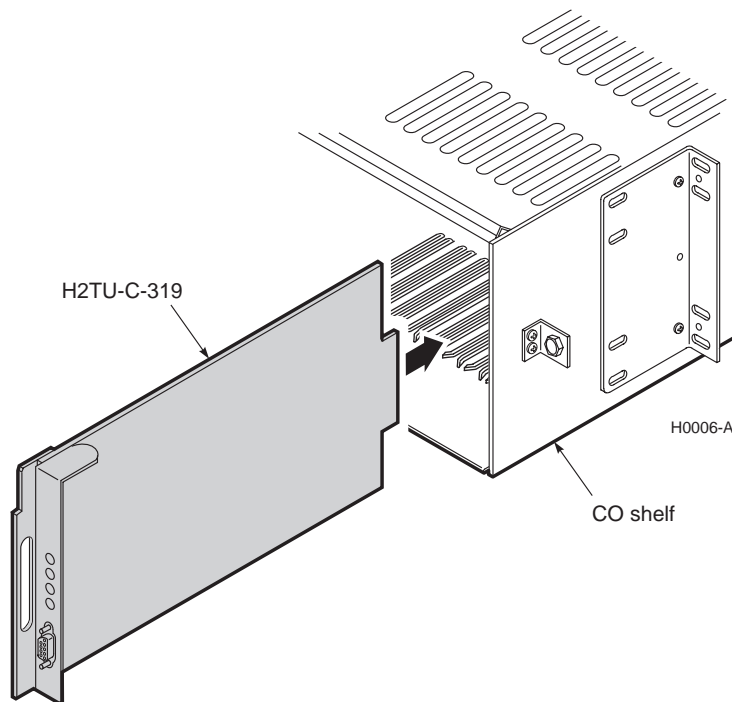

Figure 2. Installing an H2TU-C into a Shelf



Upon receipt of the equipment, inspect the contents for signs of damage. If the equipment has been damaged in transit, immediately report the extent of damage to the transportation company and to ADC.



When installing an H2TU-C in a chassis, be sure to wear an antistatic wrist strap. Avoid touching components on the circuit board.



To comply with the intrabuilding wiring requirements of GR-1089 CORE, Section 4.5.9, the shields of the ABAM-type cables that connect the H2TU-C DSX-1 output ports to the cross-connect panel must be grounded at both ends.

- 1 Align the H2TU-C with the enclosure slot guides, then push the unit in until it touches the backplane card-edge connector.
- 2 Place your thumbs on the H2TU-C front panel and push the H2TU-C firmly into the slot guides until the unit clicks into the backplane and is properly seated.

VERIFICATION

Once the H2TU-C is installed, verify that it is operating properly. To do this, monitor the front-panel status LEDs.

- 1 Verify that as the H2TU-C powers up, it attempts to communicate with a remote unit as the DSL LED flashes red once every second. (Table 2 on page 5 lists the status messages.)
 - If the H2TU-C is unable to communicate with the H2TU-R, the DSL LED displays solid red, indicating HBER, MARG, or PWRF alarms.
 - If the H2TU-C is able to communicate with the H2TU-R, the DSL LED displays solid green, indicating that the HDSL2 spans are synchronized without error.
- 2 Verify the presence of a DS1 signal by confirming that the ALM LED is off (not lit). If the ALM LED displays red or yellow, a DS1 LOS condition exists. Refer to Table 2 on page 5 to locate the problem.
- 3 Verify error free DS1 transmission by confirming that the DS1, framing (ESF/SF), and line code (B8ZS/AMI) LEDs display solid colors. Refer to Table 2 on page 5 to locate the problem if these LEDs are either flashing or display solid red.

PROVISIONING

ACCESSING THE PROVISIONING SCREENS

Use a maintenance terminal (ASCII terminal or a PC running terminal emulation software) connected to the H2TU-C craft port (or to an HMU craft port) to access the status, history, inventory, and provisioning screens (see [Figure 3 on page 9](#)).



No dip switches or jumpers are required to provision the H2TU-C as it contains a non-volatile RAM (NVRAM) which stores the system option settings. System option settings are retained if shelf power is lost or the H2TU-C is unplugged.

Connecting to a Maintenance Terminal

The craft port on the front panel allows you to connect the H2TU-C to a maintenance terminal, such as an ASCII terminal or PC running a terminal emulation program. Once connected to a maintenance terminal, you can access the maintenance, provisioning, and performance screens.

To connect to a maintenance terminal:

- 1 Connect a standard 9-pin terminal cable to the RS-232 craft port on the H2TU-C front panel ([Figure 1 on page 3](#)).
- 2 Connect the other end of the cable to the serial port on the maintenance terminal.
- 3 Start a terminal emulation program such as Procomm (emulating a VT100 terminal).
- 4 Configure the maintenance terminal for the following communication settings:
 - 9600 baud
 - No parity
 - 8 data bits
 - 1 stop bit
 - Hardware flow control set to OFF
- 5 If necessary, press **CTRL** + **R** to refresh the HDSL2 logon screen.

Logon Screen

The maintenance terminal screens allow you to monitor, provision, and troubleshoot an HDSL2 system.

To select a menu from the logon screen ([Figure 3 on page 9](#)), do one of the following:

- Press the underlined letter of the menu.
- Use the **←** **→** arrow keys to select the menu, then press **ENTER**.

[Table 3 on page 9](#) summarizes the navigational keys. They are also listed in the onscreen Help menu. [Table 4 on page 10](#) describes the logon screen menus.

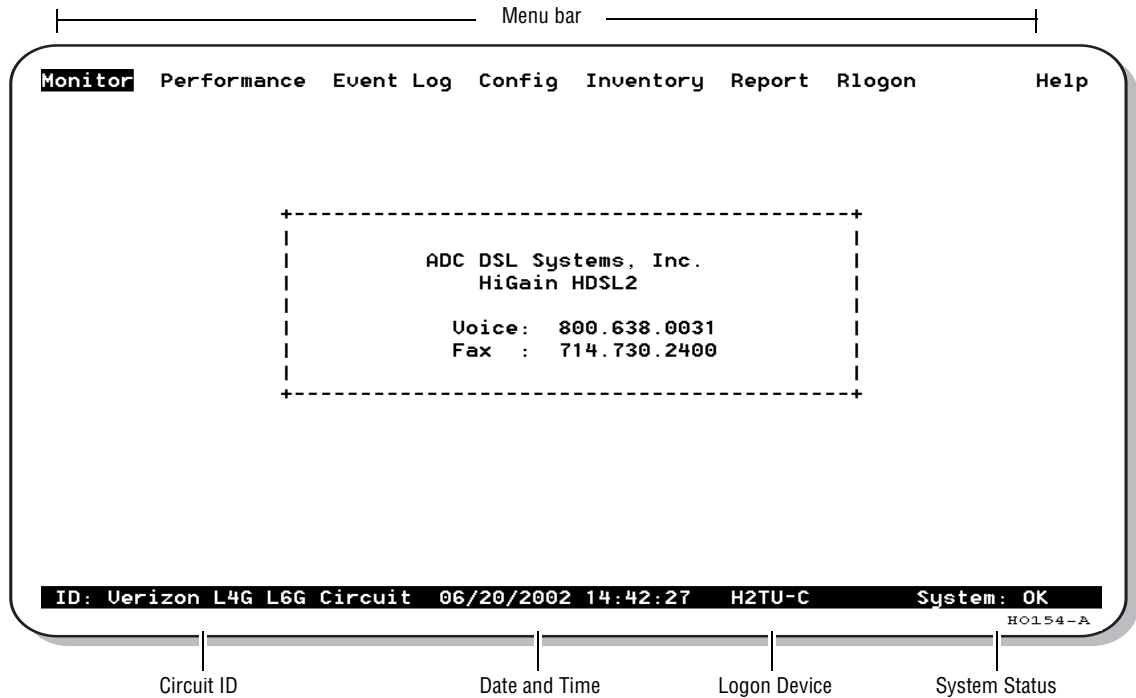

Figure 3. Logon Screen

Table 3. Navigational Keys for the Maintenance Terminal Screens

Key ^(a)	Function
SPACEBAR	Cycle through selections.
ENTER	Activate the current setting or choice, or display a menu.
ESC or F11 (VT100 only)	Return to the parent menu.
↑ or CTRL + E	Select the submenu or item above the current one, or return to the previous menu.
↓ or CTRL + X	Select the submenu or item below the current one.
→ or CTRL + D	Select the menu or item to the right of the current one.
← or CTRL + S	Select the menu or item to the left of the current one, or return to the previous menu.
CTRL + R	Refresh the screen.

(a) Legacy management units require use of control keys instead of arrow keys.



Most VT100 emulation programs support a print screen option. For Windows-based programs, such as Procomm or HyperTerminal, see the Help menu for instructions.

Table 4. Logon Screen Menus

Press this key:	To access this menu:	Menu Functions
M	Monitor	Monitors loopbacks and alarms, provides a graphical representation of circuit activity, including ES, UAS, SES, and line code.
P	Performance	Provides performance and alarm histories for current, 25-hour, 48-hour, or 31-day periods for either the DS1 or HDSL2 interface.
E	Event Log	Identifies the 100 most recent system events and reports the date and time of occurrence.
C	Config	Provides standard configuration options, ADC options, date and time setting, and a reset option (factory settings). Also provides a master clear option that clears all performance, alarm, and event log entries.
I	Inventory	Provides product information about the various devices that are in the system and lists circuit and device identifications.
O	Report	Provides four types of reports: Full Report, Short Report, System Information Report, and Event Report.
R	Rlogon/Rlogout	Remote logon can be performed from the H2TU-C or H2TU-R. The screen displays Rlogout when the H2TU-C or H2TU-R is remotely logged on to the other unit at the end of the circuit. To log off from the remote unit, press R . Rlogout changes to Rlogon. The unit is now locally logged on until R is pressed again to reinitiate the remote logon.
H	Help	Provides a glossary of terms used in the maintenance screens, a list of navigational keys, print guide, and ADC contact information.

PROVISIONING TASKS

After the H2TU-C is successfully installed, perform these basic provisioning tasks:

- Set date and time (see “Setting Date and Time” on this page).
- Set circuit ID numbers (see “Setting Circuit ID Numbers” on page 12).
- Make any configuration changes (see “Configuring the System” on page 13).
- Clear history, alarm, and event log screens to remove miscellaneous data acquired during startup (see “Clearing the History, Alarm, and Event Log Screens” on page 25).

Setting Date and Time

To set the date and time:

- 1 Press **C** to select the Config menu.
- 2 Use the **↑** and **↓** arrow keys to select **Date and Time**, then press **ENTER**.
- 3 Type the date in the format indicated (see Figure 4), then press **ENTER**.
- 4 Type the time in the format indicated (entering seconds is optional), then press **ENTER**.

```

Monitor Performance Event Log Config Inventory Report Rlogon Help
+-----+
| Standard Options  -> |
| ADC Options      -> |
| DS1 Test Jack    -> |
| Date and Time    -> |
+-----+
| Date (mm/dd/yyyy) : 06/20/2002 |
| Time (hh:mm[:ss]) : 16:04:05 |
+-----+

ID: Verizon L4G L6G Circuit 06/20/2002 16:04:34 H2TU-C System: OK
H0155-A

```

Figure 4. Config Menu - Date and Time

Setting Circuit ID Numbers

The Inventory screen provides product information on all units in the system and allows setting of the circuit and unit identification numbers.

To set the circuit ID numbers:

- 1 Press **I** to select the Inventory screen.
- 2 Type the Circuit ID number in the field indicated (see [Figure 5](#)), then press **ENTER**.
- 3 Type the ID numbers of all other devices listed in the system, pressing **ENTER** after each entry.

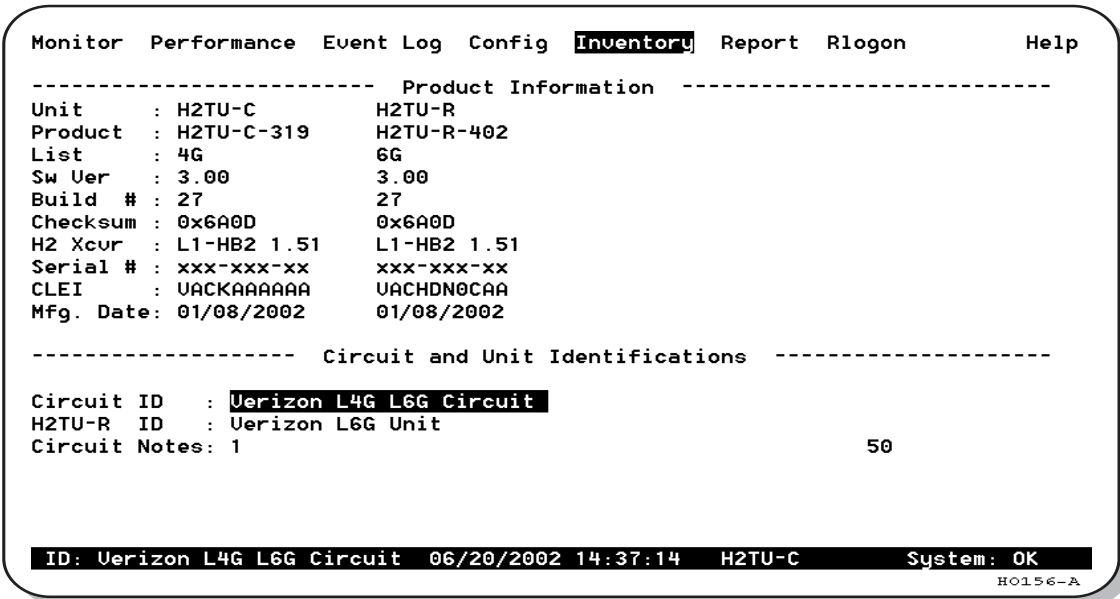

Figure 5. Inventory Screen

Configuring the System

The Config menu (see [Figure 6](#)) allows you to make the following changes:

- Standard options (see [Figure 7](#) on page 14).
- ADC options (see [Figure 8](#) on page 14).
- Program DS1 test jacks (see “Programmable DSX-1 Test Jacks” on page 50).
- Date and time (see “Setting Date and Time” on page 11).
- Master clear (see “Clearing the History, Alarm, and Event Log Screens” on page 25).
- Reset to factory default configuration (see “Resetting to Factory Defaults” on page 24).

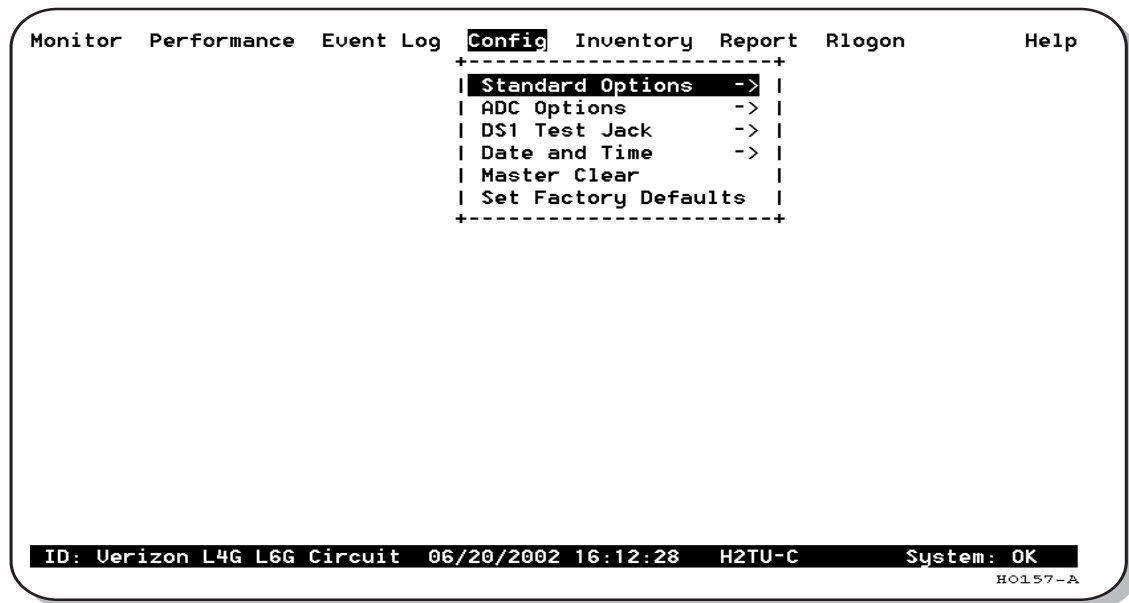

Figure 6. Config Menu

Making Changes to Standard and ADC Options

[Figure 7](#) on page 14 and [Figure 8](#) on page 14 show the Standard and ADC configuration options. Standard options are those supported by HiGain HDSL2 units when connected to units from other vendors. ADC options are an extended set of options that are only available when using HiGain units exclusively.

[Table 5](#) on page 15 and [Table 6](#) on page 16 describe the Config menu options and the available settings for each option. The settings in bold type are the factory default settings.

To make changes to these options:

- 1 Press **C** to select the Config menu.
- 2 Use the **↑** and **↓** arrow keys to select **Standard Options** or **ADC Options**, then press **ENTER**.
- 3 Use the arrow keys to select an option.
- 4 Press the **SPACEBAR** to cycle through the settings for that option.
- 5 Press **ENTER** to activate your choice.

```

Monitor Performance Event Log Config Inventory Report Rlogon Help
+-----+
| Standard Options -> |
+-----+
| Loopback Timeout (LBT0) : 120 min |
| Loop Attenuation Threshold (LATT) [0-40]: 32 dB |
| Margin Threshold (MARG) [0-15]: 4 dB |
| DS1 Frame Formatting (FRMG) : AUTO |
| DS1 Line coding (DS1) : B8ZS |
| H2TU-C Equalization (EQL) : 0 ft |
| H2TU-R Line Buildout (RLB0) : -7.5 dB |
| Alarm Pattern (ALMP) : AIS |
| H2TU-R TLOS Loopback (TLOS) : DIS |
| Network Loopback Pattern (NLBP) : AIS |
| Power Back Off Network (PBON) : DEF |
| Power Back Off Customer (PBOC) : DEF |
+-----+

Use <Spacebar> to cycle through option settings and <Enter> to activate
ID: Verizon L4G L6G Circuit 06/20/2002 16:16:01 H2TU-C System: OK
H0158-A
    
```

Figure 7. Config Menu - Standard Options (defaults shown)

```

Monitor Performance Event Log Config Inventory Report Rlogon Help
+-----+
| Standard Options -> |
| ADC Options -> |
+-----+
| Line Power Feed (PWRF) : ON |
| Remote Provisioning (RTPU) : ENA |
| Bipolar Violation Transparency (BPUT) : DIS |
| DS1 BER (DBER) : DIS |
| HDSL2 BER Threshold (HBER) : 1E-6 |
| Special Loopback Mode (SPLB) : GNLB |
| Smartjack Loopback (LPBK) : ENA |
| Minor Alarm (ALM) : DIS |
| Network AIS Pattern (NAIS) : CI |
| Performance Report Messaging (PRM) : S+N |
| RAI to RAI-CI toward NET (RACI) : ENA |
| ESF-RAI to SF-RAI Overwrite (ROUR) : ENA |
| H2TU-R DS1 Frame Conversion (CONU) : OFF |
| Fractional T1 Mode (FT1) : DIS |
+-----+

Use <Spacebar> to cycle through option settings and <Enter> to activate
ID: Verizon L4G L6G Circuit 06/20/2002 16:20:06 H2TU-C System: OK
H0159-A
    
```

Figure 8. Config Menu - ADC Options (defaults shown)

Table 5. H2TU-C Standard Config Menu Options

Standard Config Menu Options	Selection	Description
Loopback Timeout (LBTO)	NONE	Disables automatic time-out cancellation of all loopbacks.
	20 min	Sets automatic cancellation of all loopbacks to 20 minutes after initiation.
	60 min	Sets automatic cancellation of all loopbacks to 60 minutes after initiation.
	120 min	Sets automatic cancellation of all loopbacks to 120 minutes after initiation.
Loop Attenuation Threshold (LATT)	0 through 40 dB	Determines the maximum loop attenuation before an alarm is declared. Zero disables the alarm. The loop attenuation threshold can only be set through the maintenance screens.
	32 dB	Default value.
Margin Threshold (MARG)	0 to 15 dB	Determines the minimum allowable margin below which a system alarm can occur. Zero disables the alarm. The Margin (Alarm) Threshold can only be set through the maintenance screens.
	4 dB	Default value.
DS1 Frame Formatting (FRMG)	AUTO	Configures the HDSL2 system to operate in an auto-framing (AUTO) mode in which it continuously searches the input DS1 bit stream for a valid SF or ESF frame pattern. Both line and path performance parameters are maintained. Unframed payloads will cause the ES-P and SES-P counters to increment.
	SF	Configures the HiGain HDSL2 system to search for the SF framing pattern at its DS1 input.
	ESF	Configures the HiGain HDSL2 system to search for the ESF framing pattern at its DS1 input.
	UNFR	Configures the HDSL2 system to operate in an unframed mode. This mode disables the auto framing process and forces the system to function as a transparent bit pipe. Only line parameters are considered when monitoring DS1 performance.
DS1 Line Coding (DS1)	B8ZS	Places both the H2TU-C and H2TU-R into their B8ZS modes.
	AMI	Places both the H2TU-C and H2TU-R into their AMI modes.
H2TU-C Equalization (EQL) See "H2TU-C Equalization (EQL) Option." on page 17.	0 ft	Sets the equalizer to DSX-1 for 0 to 132 feet.
	133 ft	Sets the equalizer to DSX-1 for 133 to 265 feet.
	266 ft	Sets the equalizer to DSX-1 for 266 to 398 feet.
	399 ft	Sets the equalizer to DSX-1 for 399 to 532 feet.
	533 ft	Sets the equalizer to DSX-1 for 533 to 655 feet.
H2TU-R Line Buildout (RLBO)		Sets the DS1 receive level output toward the Customer Interface (CI). H2TU-R Line Buildout can only be set through the maintenance screens.
	0 dB	Sets the DS1 RLBO level toward the CI to 0 dB.
	-7.5 dB	Sets the DS1 RLBO receive level toward the CI to -7.5 dB.
Alarm Pattern (ALMP) See "Alarm Pattern (ALMP) Option." on page 17.	AIS	Enables the HDSL2 system to output an AIS payload at its DS1 ports for LOSW and DS1 LOS. For priority resolution, see Figure 26 on page 44 .
	LOS	Enables the HDSL2 system to output an LOS condition at its DS1 ports for LOSW and DS1 LOS.
H2TU-R TLOS Loopback (TLOS)	ENA	Enables a logic loopback at the H2TU-R when an LOS occurs at its DS1 input, if enabled at the H2TU-R. For priority resolution, see Figure 26 on page 44 .
	DIS	Disables Transmit Loss of Signal (TLOS) logic loopback.

Continued

Table 5. H2TU-C Standard Config Menu Options (Continued)

Standard Config Menu Options	Selection	Description
Network Loopback Pattern (NLBP)	AIS	Enables the H2TU-R to transmit an AIS toward CI for any network loopback. For priority resolution, see Figure 26 on page 44 .
	LOS	Enables the H2TU-R to transmit an LOS toward CI for any network loopback.
Power Back Off - Network (PBON) See “Power Back Off Customer (PBOC) and Power Back Off Network (PBON) Options” on page 18.	DEF	Configures the power output levels of the H2TU-C network unit toward the customer to comply with the Default template as defined in Section 6.1.4.2 of ANSI T1/E1.4.
	ENH	Configures the power output levels of the H2TU-C network unit toward the customer to comply with the Enhanced template as defined in Section 6.1.4.2 of ANSI T1/E1.4.
Power Back Off - Customer (PBOC) See “Power Back Off Customer (PBOC) and Power Back Off Network (PBON) Options” on page 18.	DEF	Configures the power output levels of the H2TU-R customer unit toward the network to comply with the Default template as defined in Section 6.1.4.2 of ANSI T1/E1.4.
	ENH	Configures the power output levels of the H2TU-R customer unit toward the network to comply with the Enhanced template as defined in Section 6.1.4.2 of ANSI T1/E1.4.

Table 6. H2TU-C ADC Config Menu Options

ADC Config Menu Options	Selection	Description
Line Power Feed (PWRF)	OFF	Disables powering to the HDSL2 pair.
	ON	Keeps the HDSL2 line voltage at nominal -180 Vdc.
Remote Provisioning (RTPV)	ENA	Enables provisioning at the H2TU-R remote unit
	DIS	Disables provisioning at the H2TU-R remote unit
Bipolar Violation Transparency (BPVT) See “Bipolar Violation Transparency (BPVT) Option” on page 18.	ENA	Enables HDSL2 CRC and BPV errors at the DS1 input to be converted into DS1 BPVs at the DS1 output at the distant end. This makes HDSL2 transparent to BPVs.
	DIS	Disables BPV Transparency.
DS1 BER (DBER) See “DS1 BER (DBER) Option” on page 18.	ENA	Enables the fixed 24-hour DS1 BER threshold (10^{-6}).
	DIS	Prevents the generation of a system alarm due to DS1 BER.
HDSL2 BER Threshold (HBER) See “HDSL2 BER Threshold (HBER) Option” on page 19.	1E-6	Front-panel alarm is displayed and the Status LED flashes red when the Block Error Rate (BER) threshold exceeds 10^{-6} . BER is based on the definition of Bit Error Rate.
	1E-7	Front-panel alarm is displayed and the Status LED flashes red when the Block Error Rate (BER) threshold exceeds 10^{-7} .
	NONE	Prevents generation of a system alarm due to BER.
Special Loopback Mode (SPLB) See “Special Loopback (SPLB) Mode” on page 46.	GNLB	Configures the HDSL2 system to respond to the generic inband loopback codes.
	A3LB	Configures the HDSL2 system to respond to the inband loopback codes of the Wescom addressable repeater.
SmartJack Loopback (LPBK)	ENA	Enables the HDSL2 system to recognize all inband SmartJack (SMJK) loopback commands.
	DIS	Configures the HDSL2 system to ignore all inband SmartJack loopback commands.

Continued

Table 6. H2TU-C ADC Config Menu Options (Continued)

ADC Config Menu Options	Selection	Description
Minor Alarm (ALM)	ENA	Enables the generation of the output alarm on pin H when a system alarm condition occurs.
	DIS	Disables the generation of the output alarm on pin H when a system alarm condition occurs.
Network AIS Pattern (NAIS)	CI	If ALMP is set to AIS, this option specifies which pattern is sent to the network when a remote LOS or AIS occurs. When configured for CI, an AIS-CI pattern is sent to the network. For priority resolution, see Figure 26 on page 44 .
	AIS	When configured for AIS, an AIS pattern is sent to the network.
Performance Report Messaging (PRM)	SPRM	The H2TU-R generates Supplemental PRM (SPRM) every second if no PRM is present from the CPE within 5 seconds of a reset or an LOS/AIS/OOF condition occurs. TL1 commands and responses are enabled.
	NPRM	The H2TU-R generates Network PRM (NPRM) if no PRM is present from the CPE. If the CPE is sending PRMs, NPRM is generated, in addition to the existing PRM, every second. TL1 commands and responses are enabled.
	S + N	The H2TU-R generates an NPRM which is tagged on to an SPRM every second. The H2TU-R generates SPRM if no PRM is present from the CPE. If the CPE is sending PRM, the PRM is converted to an SPRM. TL1 commands and responses are enabled.
	OFF	ESF Datalink (DL) is completely transparent. No PRMs are generated. There are no TL1 responses unless the system is first armed by a TL1 command, which enables Performance Monitoring.
RAI to RAI-CI towards NET See “RAI to RAI-CI toward NET (RACI) Option” on page 19.	ENA	Allows DS1 RAI (yellow alarm) signal received by the H2TU-R to be converted to an RAI-CI signal towards the network.
	DIS	Prevents conversion of the DS1 RAI to an RAI-CI signal.
ESF-RAI to SF-RAI Overwrite (ROVR) See “ESF-RAI to SF-RAI Overwrite (ROVR) Option” on page 20.	ENA	If the CONV option is set to FCON or ACON, an ESF DS1 payload from the network with an embedded RAI pattern is converted to an SF-RAI pattern toward the CI at the H2TU-R.
	DIS	Prevents conversion to an SF-RAI pattern.
H2TU-R DS1 Frame Conversion (CONV) See “H2TU-R DS1 Frame Conversion (CONV) Option” on page 20.	OFF	Framing determined by the DS1 frame formatting option.
	ACON	Auto (ACON) detection of framing and potential frame conversion at the remote.
	FCON	Auto detection of framing and forced frame format conversion (FCON) at the H2TU-R.
Fractional T1 Mode See “Fractional T1 Mode (FT1) Option” on page 22.	ENA	Enables system response to DDS latching loopback commands for fractional T1 applications, CP disconnect, and trouble indication. For priority resolution, see Figure 26 on page 44 .
	DIS	Disables system response to DDS latching loopback commands for fractional T1 applications, CP disconnect, and trouble indication.

H2TU-C Equalization (EQL) Option. The equalizer shapes the DS1 output signal of the H2TU-C to conform to a very specific pulse template when it arrives at the DSX-1 cross-connect point. The degree of pulse-shaping required is a function of the distance between the H2TU-C equipment bay and the DSX-1 panel. Thus, the equalizer has six discrete settings, in increments of 133 feet to cause the maximized separation of 655 feet.

Alarm Pattern (ALMP) Option. To improve HiGain HDSL2 compatibility with the switch-to-protect features used in Digital Loop Carrier (DLC) feeder applications, the H2TU-C has an Alarm Pattern (ALMP) option that allows you to select either an AIS or LOS DS1 output payload for the following alarms:

- LOSW on any loop
- LOS DS1

Power Back Off Customer (PBOC) and Power Back Off Network (PBON) Options. Power Back Off Customer (PBOC) and Power Back Off Network (PBON) allow the HDSL circuit to support two transmit power templates: default (DEF/higher level) and enhanced (ENH/lower level). These are defined in Section 6.1.4.2 of the ANSI T1E1.4 HDSL2 standard. Each HDSL2 receiver detects the level it is receiving during the start-up, pre-activation sequence. It then compares this level to the level it should be receiving according to the PBOC and PBON option settings (DEF or ENH). If the received level is outside the template limits, the receiver sends a message to the upstream HDSL2 transmitter requesting the proper level. These levels are adjusted only during the start-up routine or if the PBOC or PBON option settings are changed during normal operation. Since the ENH template levels are up to 15 dBm below those of the DEF template, the ENH setting can be used to reduce crosstalk levels into adjacent circuits. (For example, if crosstalk noise is being induced by the H2TU-R, set the PBOC option to its lower (ENH) level setting. Conversely, if the HDSL2 signal at the H2TU-R is being affected by crosstalk noise induced from adjacent pairs, set the PBOC option to its higher (DEF) level setting.



Changing these Power Back Off option settings on a live circuit causes the HDSL2 loop to momentarily drop and then reacquire synchronization. This setting can also affect the operating margins.

Bipolar Violation Transparency (BPVT) Option. The H2TU-C improves compatibility with Digital Loop Carrier (DLC) feeder applications because of its ability to transmit DS1 BPV occurrences between its DS1 interfaces. This feature is required to support protection switching in DLC applications. Each DLC terminal must be able to monitor the integrity of its Receive DS1 payload and then switch to the protect line when the integrity of the path drops below specific user selected limits. An essential requirement of this feature is the need for each DLC terminal to detect BPVs in its DS1 input. Standard HDSL systems correct DS1 BPVs at the input and, therefore, prevent them from being detected by the DLC terminals to which they are connected. The H2TU-C and its associated remote units remove this limitation and become BPV transparent by detecting and counting input BPVs at each end and then by replicating them at the DS1 output port of the distant end.

The BPV count is converted into BPVs at the distant end during the following second at a rate of 1 BPV every 128 DS1 bits up to a maximum of 12000 ($BER = 7.7 \times 10^{-3}$). This maximum rate is more than adequate since it exceeds the maximum 10^{-3} BER required by most DLC systems.

DS1 BER (DBER) Option. The DS1 BER alarm occurs when any of the DS1 or DSX-1 performance monitoring parameters listed in Table 7 exceed the counts shown for the 24-hour period between 12:00:00 AM through 11:59:59 PM. These thresholds correspond to a 10^{-6} BER. All PM counters clear to zero at 12:00:00 AM or when Master Clear is selected.

Table 7. DS1 and DSX-1 24-Hour PM Threshold

Parameter	Threshold Count
CV-L (BPV)	133,400
ES-L, ES-P, PRM, PDVS-L	648
SES-L, SES-P	100
UAS-P, UAS-L	10

HDSL2 BER Threshold (HBER) Option. The HBER option permits the monitoring of loop integrity and reporting of alarms when excessive errors are detected. The PM primitive used for this purpose is the CRC checksum performed on the HDSL2 frame for both directions of transmission. It is, therefore, called a block error rate rather than the bit error rate associated with the DS1 interface. The CRC errors and counts are displayed on the Monitor screen for both the H2TU-C and H2TU-R. The HBER option allows an alarm to be generated if the total number of CRCs at either the H2TU-C or H2TU-R exceeds the selected BER threshold during the last 1-minute interval.

- HBER option = 1E-6. Alarm is generated if CRC > 93
- HBER option = 1E-7. Alarm is generated if CRC > 9

Once initiated, the HBER count clears when the CRC count drops below the selected threshold. Selecting NONE inhibits this alarm.

RAI to RAI-CI toward NET (RACI) Option. The H2TU-C in conjunction with the H2TU-R supports the RAI-CI function.

The RAI-CI signal is a RAI signal which contains a signature indicating that an LOF or AIS failure has occurred in the customer installation (CI) at the H2TU-R unit and that the defect or failure which caused the origination of that RAI is not found in the signal from the network. Therefore, RAI-CI is transmitted toward the network when the following two conditions are simultaneously true at the point from which RAI-CI originated (at the H2TU-R, toward the network):

- Condition 1—RAI is received from the CI.
- Condition 2—No LOF, LOS, or AIS failure is detected in the signal received from the network.

Sending RAI-CI terminates within 500 μ s when either of the following occurs:

- Cessation of RAI from the CI.
- Declaration of LOF, LOS, or AIS in the signal from the network.

To prevent the transmission of RAI-CI during the failure-clearing interval of a network failure, the transition from RAI to RAI-CI is delayed for 20 seconds following the detection of conditions 1 and 2 above. Since RAI-CI meets the definition of RAI, it may be detected and used exactly as RAI. The longer period of time required for detection of RAI-CI does not affect its use for functions which require RAI.

The RAI-CI pattern is a function of the payload frame format as follows:

- ESF—The RAI-CI signal is a repetitive pattern in the Frame Bit for Data Link (FDL) with a period of 1.08 seconds. RAI-CI is formed by sequentially interleaving 0.99 (+/- 2 ms) seconds of the normal message 00000000 11111111 (right-to-left) with 90 milliseconds (+/- 2 ms) of the message 00111110 11111111 (right-to-left) to flag the signal as RAI-CI.
- SF—The SF-RAI-CI signal is transmitted inband by setting each of the 24 channel time lots to 1000 1011 (left-to-right). In addition to the criteria specified above, the generation of SF-RAI-CI has to be held off for 1 second to examine the DS0s for a framed, all-zeros pattern. If present, the generation of SF-RAI-CI is suspended for the duration of the all-zeros pattern.



Since the RAI to RAI-CI conversion modifies the payload, an RACI option is available to inhibit the RAI to RAI-CI conversion for those applications that cannot tolerate payload modifications.

ESF-RAI to SF-RAI Overwrite (ROVR) Option. If the ESF-RAI to SF-RAI Overwrite (ROVR) option is enabled, it allows a network ESF-RAI or ESF-RAI-CI pattern to be converted into a CPE SF-RAI or SF-RAI-CI pattern.

If the ROVR option is disabled, it prevents conversion of a network ESF payload with an embedded RAI pattern. Disabling the ROVR option preserves the integrity of the CPE payload as it was originally transmitted.

H2TU-R DS1 Frame Conversion (CONV) Option. Frame format conversion is only applicable to the remote H2TU-R, but selectable by the H2TU-C or H2TU-R. This option enables the network to be ESF, which is used to embed SPRM or NPRM into the datalink towards the network. During conversion, frame bit errors are regenerated to ensure transparency.

The HDSL2 system attempts to find ESF or SF framing or determines that no framing exists. The DS1 framing is then synchronized with the HDSL2 frame. If the framing is lost, the system generates an Out-of-Frame (OOF) defect which results in Unavailable Seconds - Path (UAS-P). As a result, the system reverts to frame search mode.

This option has the following settings:

- OFF: No frame conversion takes place. All framing issues are determined by the FRMG option settings of AUTO and UNFR.
- ACON: This is the automatic conversion setting. If the system detects ESF from the network and SF from the CPE, it automatically converts the CPE SF to ESF towards the network as well as the network ESF to SF towards the CPE.

Upon power-on-reset, after loopdown, or after changing the frame conversion option, the framing needs to be re-established before a complete conversion takes place. If there is a failure condition (LOS, AIS, or LOF) during steady state, the previous conversion state is maintained to ensure continuity when the system returns from the failure condition.

If SF is received from the network, the H2TU-R forces an ESF towards the network for about 1.5 seconds. This signals to the far-end PM-NIU at the network boundary that frame conversion is requested. If the far-end PM-NIU is capable of conversion, it changes the framing to ESF. If not, then the H2TU-R reverts to SF and does not apply any conversion.

If an ESF is received from the CPE, it is passed on to the network, and the network's inbound framing is passed on to the CPE.

- FCON: This is the forced conversion setting. [Table 8](#) lists the HiGain HDSL2 responses to both the ACON and FCON settings for the CONV option. The responses are identical, except in cases 3 and 4. In these cases, the FCON reply is attempting to force the network (or the far-end PM-NIU) to send ESF. It also alerts the CPE with an AIS alarm pattern while forcing the ESF to the network. Continuity is maintained as for ACON. [Table 9 on page 21](#) and [Table 10 on page 21](#) list the ESF and SF frame formats, respectively.

Table 8. Response to H2TU-R DS1 Frame Conversion Options

Case Number	NET Transmit	CPE Transmit	ACON Option	FCON Option
			NET > CPE NET < CPE	NET > CPE NET < CPE
1	ESF	SF	ESF → SF ESF ← SF	ESF → SF ESF ← SF
2	ESF	ESF	ESF → ESF ESF ← ESF	ESF → ESF ESF ← ESF
3	SF	ESF	SF → SF ESF ← ESF	SF → AIS ESF ← ESF
4	SF	SF	SF → SF SF ← SF	SF → AIS ESF ← SF

Table 9. *Extended SuperFrame Format*

ESF Number	Frame Bits		
	Framing Pattern Sequence (FPS) - 2 kb/s	Frame Bit for Datalink (FDL) - 4 kb/s	Cyclical Redundancy Check (CRC) Bits - 2 kb/s
1		m	
2			C1
3		m	
4	0		
5		m	
6			C2
7		m	
8	0		
9		m	
10			C3
11		m	
12	1		
13		m	
14			C4
15		m	
16	0		
17		m	
18			C5
19		m	
20	1		
21		m	
22			C6
23		m	
24	1		

Table 10. *SuperFrame Format*

SF Number	Frame Bits	
	Terminal Framing Bit	SuperFrame Signaling Bit
1	1	
2		0
3	0	
4		0
5	1	
6		1
7	0	
8		1
9	1	
10		1
11	0	
12		0

Fractional T1 Mode (FT1) Option. Fractional T1 circuits can be used in feeder networks to provide frame relay service. If such circuits are maintained by a DDS test group, then these circuits must respond to DDS/DS0 latching loopback commands, the only tool test groups have at their disposal. A latching loopback, once it has been initiated by the correct sequence, remains locked or “latched” until the correct loopdown sequence has been detected.

The FT1 option, when enabled, allows the H2TU-C to respond to DS0 latching loopback commands and, therefore, support fractional T1 frame-relay applications. This is in addition to the standard full bandwidth T1 2-in-5 loopup and 3-in-5 loopdown SmartJack commands. FT1 supports both the full T1 commands of ENA and the new DDS latching loopback commands, which must also be enabled. (For more information about latching loopback commands, refer to BellCore TA-TSY-000077, Issue 3, April 1986.)

The FT1 option supports both the DDS NI and DDS DS0 Data Port (DP) latching loopback sequences listed in Table 11.

Table 11. DDS NI and DS0 DP Latching Loopback Sequence

Enable Sequence	Minimum Number of Bytes	Byte Name	Network Code
1	35	Transition in Progress (TIP)	S0111010
2A	35	NI Loop Select Code (LSC)	S1000001
2B	35	DS0 DP Loop Select Code (LSC)	S0000101
3	100	Loopback Enable Code (LBE)	S1010110
4	35	All Ones	S1111111
5	100	LBE	S1010110
6	32	Far End Voice (FEV)	S1011010
Disable/Loopdown	35	TIP	S0111010

The sequences in Table 11 are sent in time slot 1. The S in the Network Code column is a “don’t care” bit. The loopback is activated after the detection of Sequence 6. Upon completion of the enable sequence, the Test Center continues to transmit FEV bytes in multiples of 20 until FEV confirmation bytes are returned, or until about 2 seconds have elapsed. If the confirmation bytes are not received, a failed attempt is reported. Anticipate the minimum number of bytes when the loopback code is transmitted by a pre-programmed machine test pattern generator. These minimum number of bytes will most likely be exceeded when the codes are sent manually. Also, manual testing may inject random data signals between valid control sequences. The detection algorithm ignores these occurrences and only responds to valid control codes.

Table 12 lists the relationship between the latching loopback sequences and the specific HiGain HDSL2 loopback they initiate.

Table 12. HiGain HDSL2 Loopback vs. Latching Sequence

HiGain HDSL2 Loopback	Latching Sequence
NREM	1, 2A, 3, 6
NLOC	1, 2B, 3, 6

The NLOC loopback is called tandem DS0 DP loopback. It is used to select one of many loopback points when there are several identical data ports in tandem. The NI loopback is assigned to the H2TU-R (NREM) since it is usually located at the Network Interface (NI). The DS0 DP tandem loopback is assigned to the rest of the HiGain HDSL2 loopbacks because most DDS test sets support this tandem command set.

The Test Center transmits a group of 40 TIP bytes to loop down the loopback. It continues to transmit TIP bytes in multiples of 20 until the TIP bytes are not returned or until about 2 seconds have elapsed. If the bytes are absent, a successful loopdown is reported; otherwise, a failed loopdown is reported. The loopdown can also be initiated by depressing the H2TU-R loopback control pushbutton or by any of the standard 3-in-5 loopdown commands. The implemented detection or release loopback algorithm functions properly in the presence of a 10^{-3} bit error rate.

Since the FT1 mode is a combination of both the full T1 and the latching loopback modes, all codes are always active. Therefore, if a loopback is initiated by a latching sequence, it can be looped down by either a latching or generic loopback and vice versa. All loopback commands are completely symmetric in the FT1 mode.

If the latching sequence shown in Table 12 (page 22) is interrupted for more than 20 minutes, the detection is cleared, and the H2TU-C reverts back to its initial state where it searches for the initial sequence 1.

After a successful latching sequence terminates in a latched loopback state, the state remains until the Disable command is detected, or until the LBTO option of NONE, 20, 60, or 120 minutes has expired, whichever occurs first.

The unframed AIS pattern that is normally sent towards the network for a CILOS fault condition must be replaced by the new patterns listed in Table 13 when the FT1 loopback option is selected.

Table 13. Response of H2TU-C and H2TU-R to LOS and AIS

Case	FT1 Option	H2TU-C Input	H2TU-C Output Pattern			H2TU-R Input	H2TU-R Output	Status Screen
			Framing	Payload	FDL			
1	ENA	SF	SF	01111110	N/A	LOS/AIS	AIS	RCV RLOS/RAIS XMT IDLE
2	ENA	ESF	ESF	01111110	X ^(a)	LOS/AIS	AIS	RCV RLOS/RAIS XMT IDLE
3	ENA	LOS/AIS	UNFR	01111110	N/A	LOS/AIS	AIS	RCV RLOS/RAIS XMT IDLE
4	ENA	LOS/AIS	SF	PL	X ^(a)	SF/PL	AIS	RCV LLOS/LAIS
5	ENA	LOS/AIS	ESF	PL	X ^(a)	ESF/PL	AIS	RCV LLOS/LAIS

(a) Don't care bit.

Resetting to Factory Defaults

To reset the H2TU-C to its original factory defaults:

- 1 Press **C** to select the Config menu.
- 2 Use the **↑** and **↓** arrow keys to select **Set Factory Defaults** (see Figure 9), then press **ENTER**.
- 3 Press **Y** to reset the H2TU-C or press **N** to cancel this action.



Resetting the H2TU-C to its original factory settings may cause interruption of service.

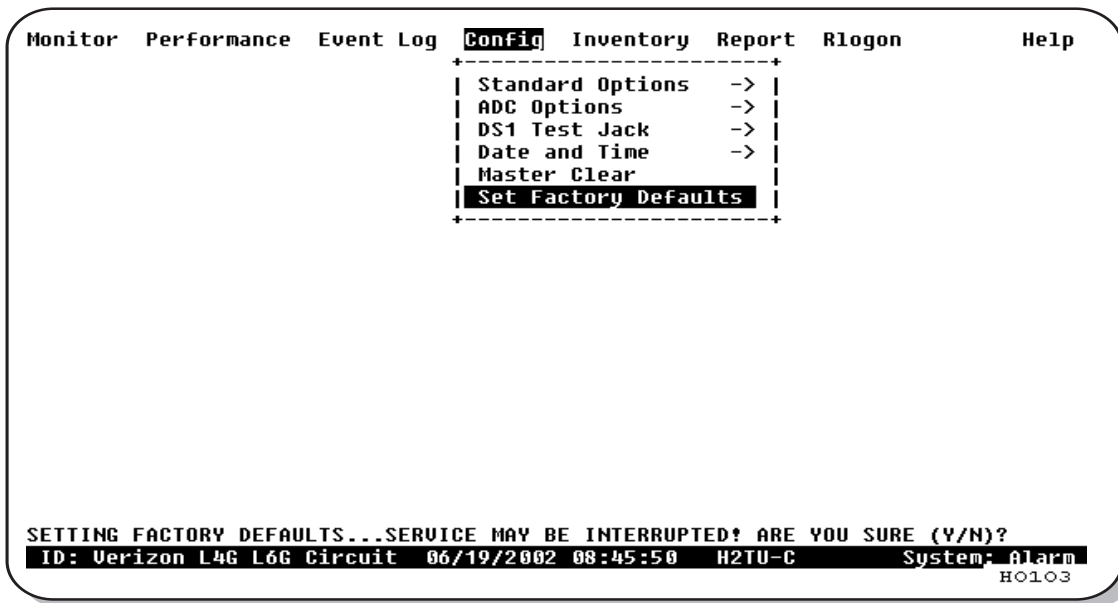

Figure 9. Config Menu - Set Factory Defaults

Clearing the History, Alarm, and Event Log Screens

Select Master Clear to clear the History, Alarm, and Event Log screens after the system has been installed and is functioning properly. This removes miscellaneous data acquired during the start-up session and ensures that you have meaningful data thereafter.

To clear the Event Log, press **E** to select the Event Log screen, then press **L** to clear the screen.

To clear an individual history or alarm screen, do the following:

- 1 Press **P** to select the Performance screen.
- 2 Press the **SPACEBAR** to select either interface (**H2TU-C DS1**, **H2TU-R DS1**, **H2TU-C HDSL2**, or **H2TU-R HDSL2**), then press **ENTER**.
- 3 Press **↓** to select statistics.
- 4 Press the **SPACEBAR** to select the type of statistics (**Current**, **Alarm History**, **25-Hour History**, **48-Hour History**, or **31-Day History**), and press **ENTER** after your selection.
 - Selecting **31-Day History** allows you to clear the current, 25-hour, 48-hour, and 31-day performance history screens for the selected interface.
 - Selecting **Alarm History** allows you to clear the alarm history screen for the selected interface. For information about the DS1 and HDSL2 Alarm screens, see [Table 15 on page 31](#) and [Table 16 on page 34](#), respectively.
- 5 Press **L** to clear the screen.
- 6 Press **Y** to confirm.

To clear ALL history, alarm, and event log screens by this method:

- 1 Press **C** to select the Config screen.
- 2 Use the **↑** and **↓** arrow keys to select **Master Clear** (see [Figure 10](#)).
- 3 Press **ENTER** to activate.
- 4 Press **Y** to clear all screens.

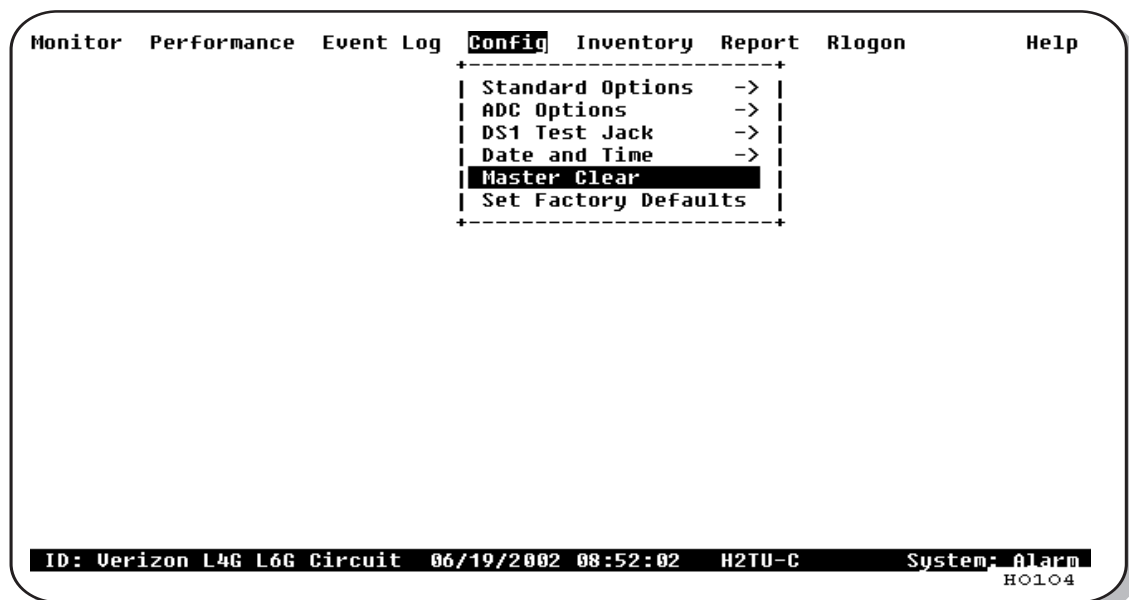

Figure 10. Config Menu - Master Clear

MONITORING SYSTEM ACTIVITY AND PERFORMANCE

The HDSL2 system provides the following maintenance screens for monitoring system activity and assessing performance.

- The Monitor screen provides a graphical representation of circuit activity and allow initiation of loopbacks.
- The Performance screens provide current, 25-hour, 48-hour, and 31-day performance histories and a continuous alarm history.
- The Event Log provides a description of the 100 most recent events, which include their origin, time and date of occurrence, and message.

USING THE MONITOR SCREEN TO VIEW SYSTEM ACTIVITY

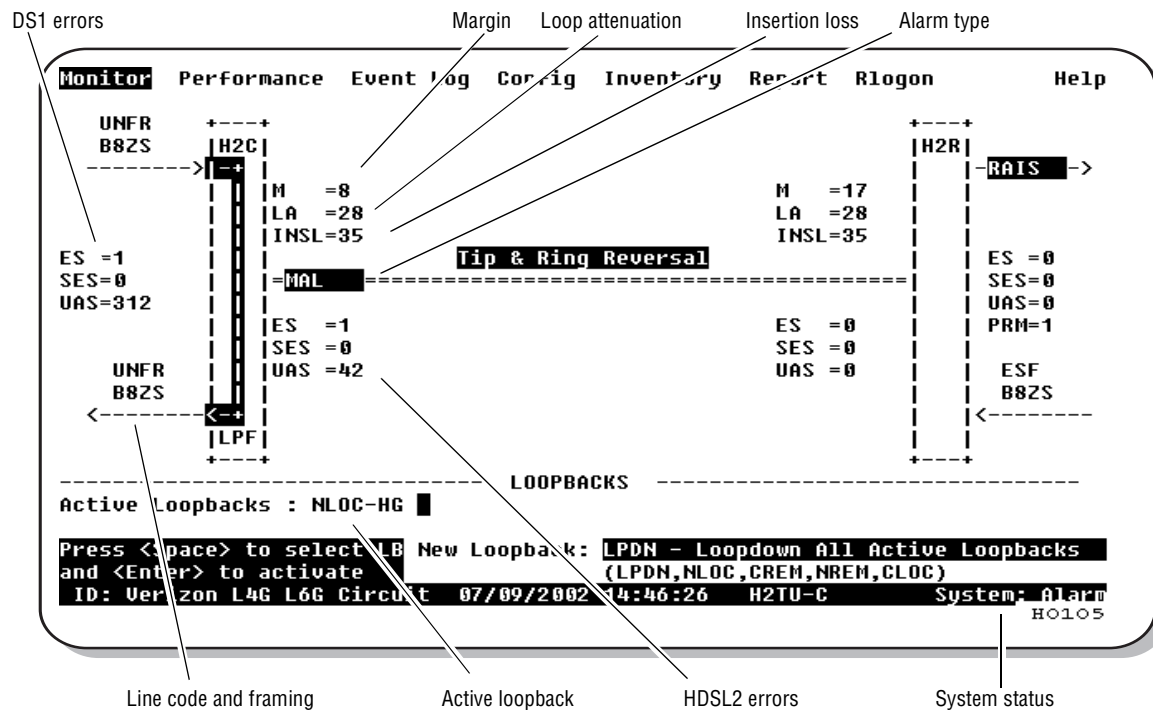

Figure 11. Monitor Screen - Active Loopback with Alarms

- 1 Press **M** to view the system diagram.
 Figure 11 shows an armed circuit with an active loopback and alarms. Terms used on the system diagram are defined in the onscreen Help menu glossary. Abnormal situations are highlighted on the diagram. Table 14 on page 27 describes the screen fields.
- 2 To initiate a loopback, press the **SPACEBAR** to cycle through the loopback choices. Press **ENTER** to make your choice.

When prompted with the message: Are you sure (Y/N)?, press **Y** to initiate the loopback or **N** to cancel. For more information about loopbacks, see “Testing” beginning on page 43.

- 3 To initiate a loopdown of all active loopbacks, press the **SPACEBAR** to select **LPDN**, then press **ENTER**. When prompted with the message: Are you sure (Y/N)?, press **Y** to initiate the loopdown or **N** to cancel.

Table 14. Monitor Screen Descriptions

Field	Description
Active Loopback	An active loopback is indicated on the lower third of the Monitor screen. Available loopbacks are indicated by gray text. See Table 23 on page 48 for a summary of the HDSL2 generic loopback codes and activation methods.
Alarm Type	Indicates type of alarm.
Code Type	Type of DS1 line coding received or sent (B8ZS or AMI).
DS1 ES Count	Errored Seconds—The sum of the Errored Seconds-Line (ES-L) and Errored Seconds-Path (ES-P) counts detected on the DS1 input over a 24-hour period. Errors include DS1 frame errors, BPV, and ESF CRC errors.
DS1 SES Count	Severely Errored Seconds—The sum of the DS1 Severely Errored Seconds-Line (SES-L) and Severely Errored Seconds-Path (SES-P) counts over the last 24 hours.
DS1 UAS Count	Unavailable Seconds—The number of seconds during which the DS1 input signal was absent over a 24-hour period.
Frame Type	Type of DS1 framing detected at the input stream (SF, ESF, or UNFR).
HDSL2 ES Count	Errored Seconds—The number of 1-second intervals that contained at least one CRC or LOSW error. This value is a running total of the last 24 Hours.
HDSL2 SES Count	Severely Errored Seconds—The number of 1-second intervals that contain at least 50 CRC errors or one or more LOSW defects. An LOSW defect occurs when at least three consecutive HDSL frames contain one or more frame bit errors. This value is a running total of the last 24-hours.
HDSL2 UAS Count	Unavailable Seconds—The number of seconds the HDSL2 loop is unavailable. This occurs after 10 contiguous HDSL SES and is retired after 10 contiguous non-SES seconds. This value is a running total of the last 24 hours.
HG or (PL)	HG displays when the loopback was initiated from a HiGain (HG) front panel or by a maintenance terminal loopback command. PL displays when the loopback was initiated by a command embedded in the DS1 data path payload (PL).
ID	Circuit identification number.
INSL	Insertion Loss—The signal loss value for a 196 kHz signal over the cable.
LA	Loop Attenuation—Indicates the attenuation of the Overlapped Pulse Amplitude Modulation Transmission with Interlocking Spectra (OPTIS) pulse from the distant end. The value is related to insertion loss at 196 kHz and should be kept under 28 dB. This value differs from the insertion loss value of a conventional 196 kHz signal.
LPF	Line Power Feed—Indicates the HDSL2 line power is on.
M	Margin—The signal-to-noise ratio at all HDSL2 ports, relative to a 10 ⁻⁷ Bit Error Rate.
MAL	Margin Alarm—Indicates the margin on HDSL2 loop has dropped below the threshold (0 to 15 dB) set by the operator.
PRM	The sum of the Performance Report Messaging - Near End (PRM-NE) and Performance Report Messaging - Far End (PRM-FE) counts.
System Status	The presence or absence of an alarm condition is indicated on the lower right corner of all screens. System: OK indicates that there are no alarms present; System: Alarm indicates the presence of an alarm. Refer to “Using the Performance Screens to View Alarm Data” on page 34 .

USING THE PERFORMANCE SCREENS TO VIEW PERFORMANCE DATA

The Performance screens display:

- CRC statistics for the HDSL2 or DS1 interface in 31-day, 48-hour, 25-hour, and current history reports.
- Alarm statistics for the DS1 interfaces (Figure 21 on page 35 and Figure 22 on page 35) or HDSL2 interfaces (Figure 23 on page 37) on a continuous basis.

To access the Performance history screens:

- 1 Press **P** to select the Performance screen.
- 2 Press the **SPACEBAR** to select either interface (**H2TU-C DS1**, **H2TU-R DS1**, **H2TU-C HDSL2**, or **H2TU-R HDSL2**), then press **ENTER**.
- 3 Press the **SPACEBAR** to select the type of statistics (**Current**, **Alarm History**, **25-Hour History**, **48-Hour History**, or **31-Day History**), then press **ENTER**.

Performance History at the DS1 Interface

The Performance History for the DS1 Interface provides a 31-day, 48-hour, 25-hour, and current statistics screens for the H2TU-C and H2TU-R (as viewed from the H2TU-C). To gain access to the Blockage Indicator History screen, you must be logged on remotely. See “Using the Performance Screens to View Performance Data” on this page for logon procedures.

Figure 12 below and Figure 14 on page 29 are examples of DS1 performance history screens at the remote unit. Figure 13 on page 29 is an example of DS1 performance history screen at the line unit. Refer to Table 15 on page 31 for descriptions of the errors reported on DS1 interface screens. Asterisks indicate performance monitoring from the previous day.

Figure 15 on page 30 and Figure 16 on page 30 show statistics for the DS1 interface at the remote unit and line unit, respectively. These screens report 1-day, 1-hour, and 15-minute statistics.

Monitor	Performance	Event Log	Config	Inventory	Report	Rlogon	Help			
H2TU-R DS1 31 Day History (Page 1 of 3)										
Date	CU-L	ES-L	SES-L	UAS-L	PDUS-L	ES-P	SES-P	UAS-P	PRM-NE	PRM-FE
05/22	-	-	-	-	-	-	-	-	-	-
05/23	-	-	-	-	-	-	-	-	-	-
05/24	-	-	-	-	-	-	-	-	-	-
05/25	-	-	-	-	-	-	-	-	-	-
05/26	-	-	-	-	-	-	-	-	-	-
05/27	-	-	-	-	-	-	-	-	-	-
05/28	-	-	-	-	-	-	-	-	-	-
05/29	-	-	-	-	-	-	-	-	-	-
05/30	-	-	-	-	-	-	-	-	-	-
05/31	-	-	-	-	-	-	-	-	-	-
06/01	-	-	-	-	-	-	-	-	-	-
06/02	-	-	-	-	-	-	-	-	-	-
Press: (N)ext Page, (P)revious Page, C(1)ear History										
Use <Space> to cycle through choices and <Enter> to view				Interface : H2TU-R DS1						
ID: Verizon L4G L6G Circuit				Statistics : 31-Day History						
06/21/2002 07:05:24				H2TU-C System: OK						
H0106										

Figure 12. H2TU-R DS1 31-Day Performance History

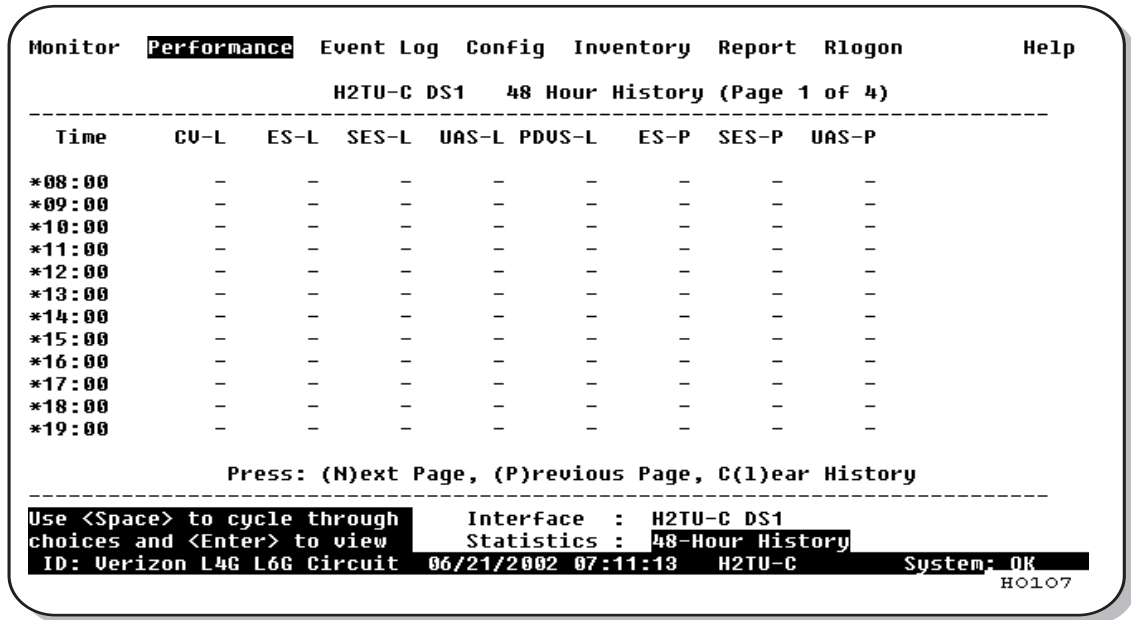

Figure 13. H2TU-C DS1 48-Hour Performance History

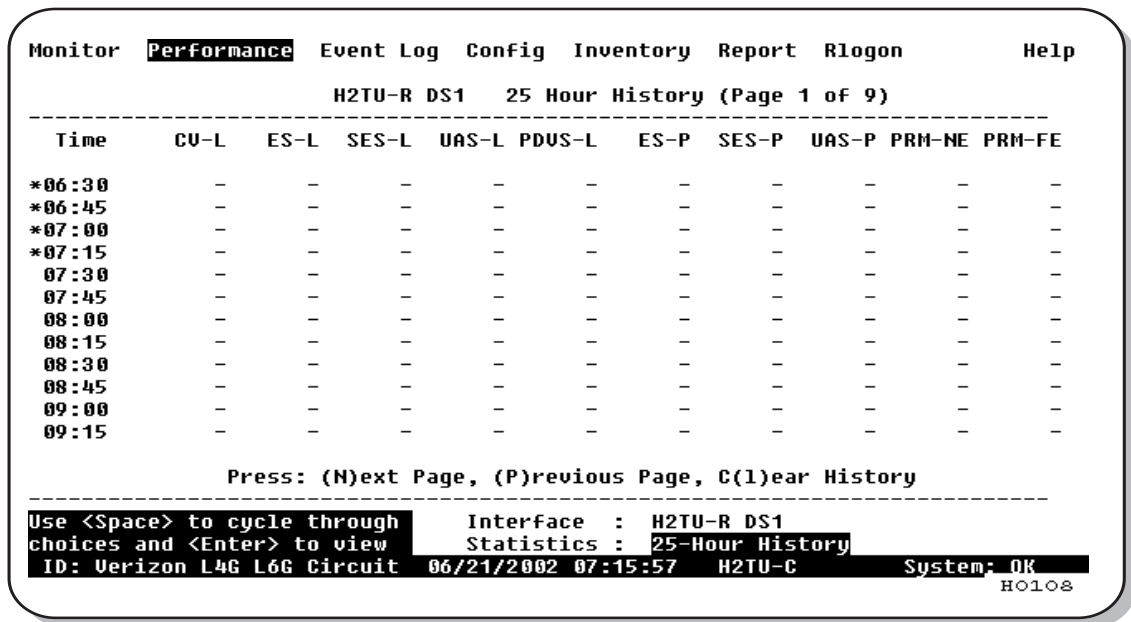

Figure 14. H2TU-R DS1 25-Hour Performance History

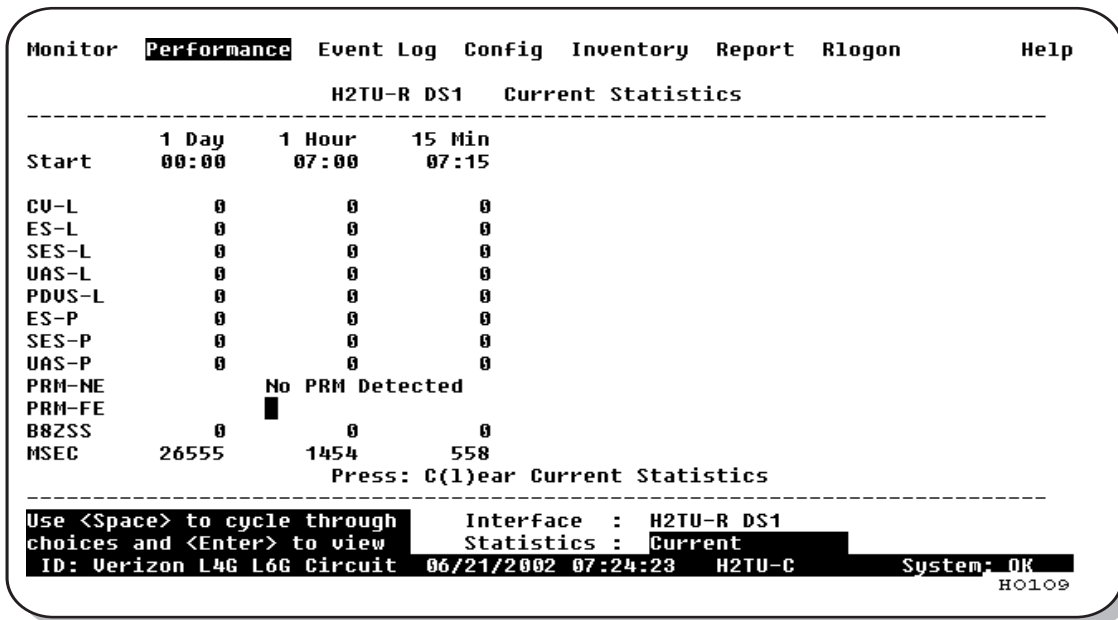

Figure 15. H2TU-R DS1 Current Statistics

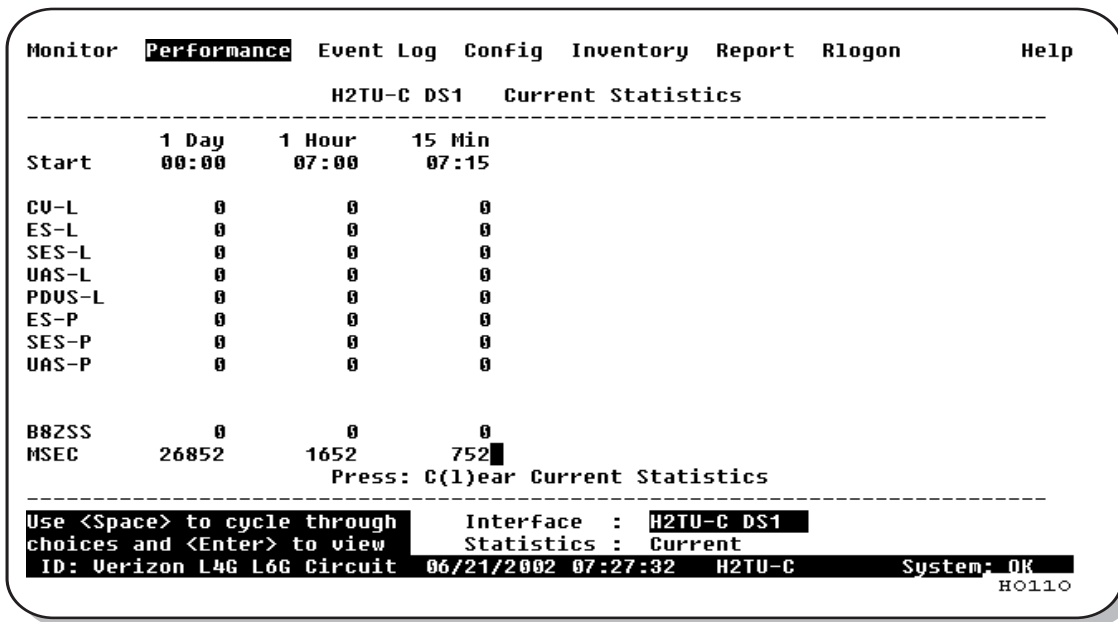

Figure 16. H2TU-C DS1 Current Statistics

Table 15. Error Acronyms Used on the DS1 Performance History Screens

Error Acronym	Description	Error Acronym	Description
CV-L	Code Violation - Line ^(a) Total BPV count.	SES-P	Severely Errored Seconds - Path Seconds with SES, CRC (ESF) ≥ 320 , or FE ^(b) (SF) $\geq 8 (F_T + F_S)$.
ES-L	Errored Seconds - Line Seconds with BPV ≥ 1 .	UAS-P	Unavailable Seconds - Path A second of unavailability based on SES-P or AIS ≥ 1 .
SES-L	Severely Errored Seconds - Line Seconds with BPV plus EXZ ≥ 1544 or LOS ≥ 1 .	PRM-NE ^(c)	Performance Report Monitoring - Near End The PRM registers in the ESF/FDL from CPE indicate errors, and the signal received from the network at the remote is error-free.
UAS-L	Unavailable Seconds - Line Seconds with LOS ≥ 1 .	PRM-FE ^(c)	Performance Report Monitoring - Far End The PRM registers in the ESF/FDL from the network indicate errors, and the signal received from the CPE is error-free.
PDVS-L	Pulse Density Violation Seconds - Line Seconds with excessive zeros (AMI = 16 zeros, B8ZS = 8 zeros).	B8ZSS ^(d)	B8ZS Monitored Seconds Seconds with B8ZS detection when AMI option is active.
ES-P	Errored Seconds - Path ^(e) Seconds with SEF ^(f) , CRC (ESF), or FE (SF) ≥ 1 .	MSEC ^(d)	Monitored Seconds of the current (15-minute/1-hour/1-day) screen.

(a) Line (L) refers to the AMI DS1 line used to transport the payload.

(b) FE is a frame bit error.

(c) Appears on H2TU-R Performance History screens.

(d) Appears on the DS1 Current Statistics screens.

(e) Path (P) refers to the total framed payload being transported between two points.

(f) Severely Errored Frame—Two or more frame bit errors occurring in a 0.75 ms interval for SF or a 3 ms interval for ESF.

Performance History at the HDSL2 Interface

The HDSL2 interface has 31-day, 48-hour, 25-hour, and current statistic screens for the H2TU-C. [Figure 17](#) and [Figure 18 on page 32](#) are examples of 31-day and 48-hour performance history screens. [Figure 19](#) and [Figure 20 on page 33](#) are examples of 25-hour and current statistics performance history screens. Refer to [Table 16 on page 34](#) for descriptions of the kinds of errors reported on all HDSL2 performance screens. Asterisks indicate performance monitoring from the previous day.

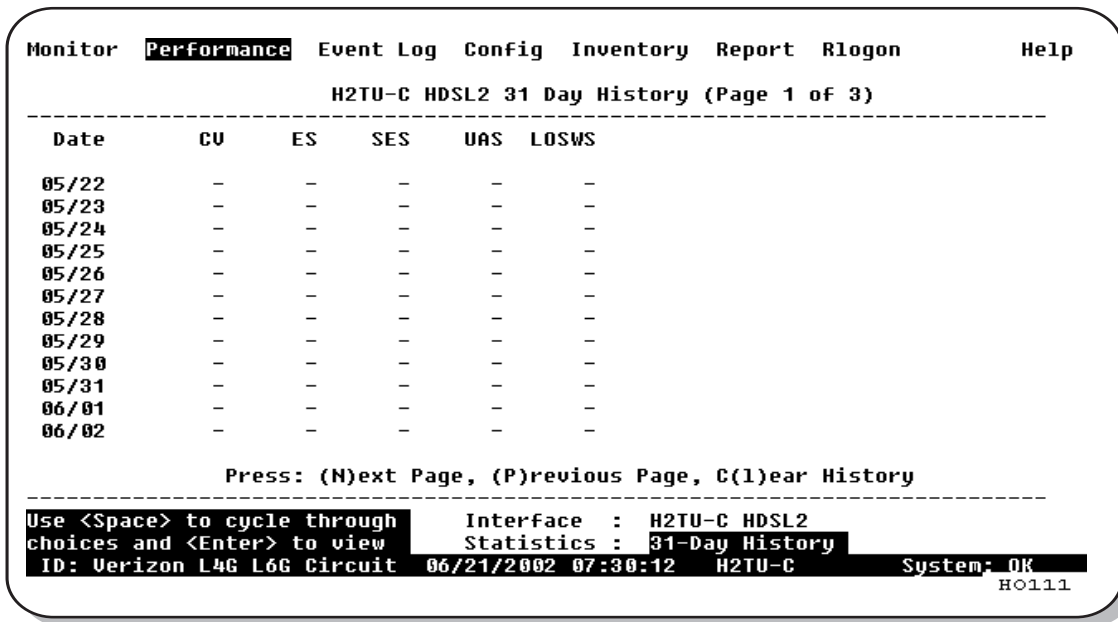

Figure 17. H2TU-C HDSL2 31-Day Performance History

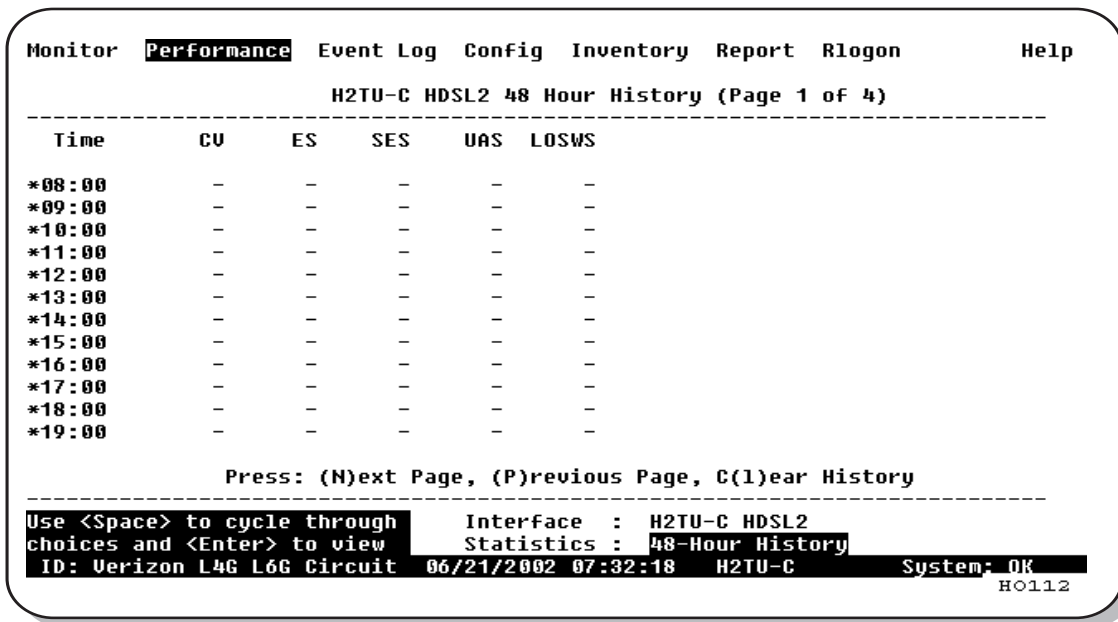

Figure 18. H2TU-C HDSL2 48-Hour Performance History

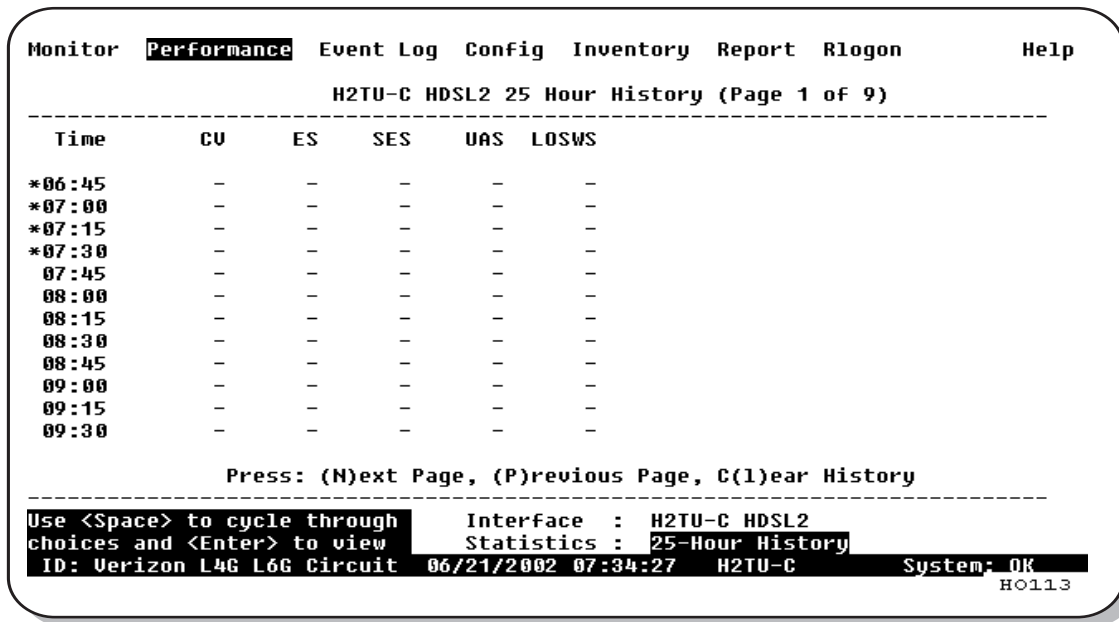

Figure 19. H2TU-C HDSL2 25-Hour Performance History

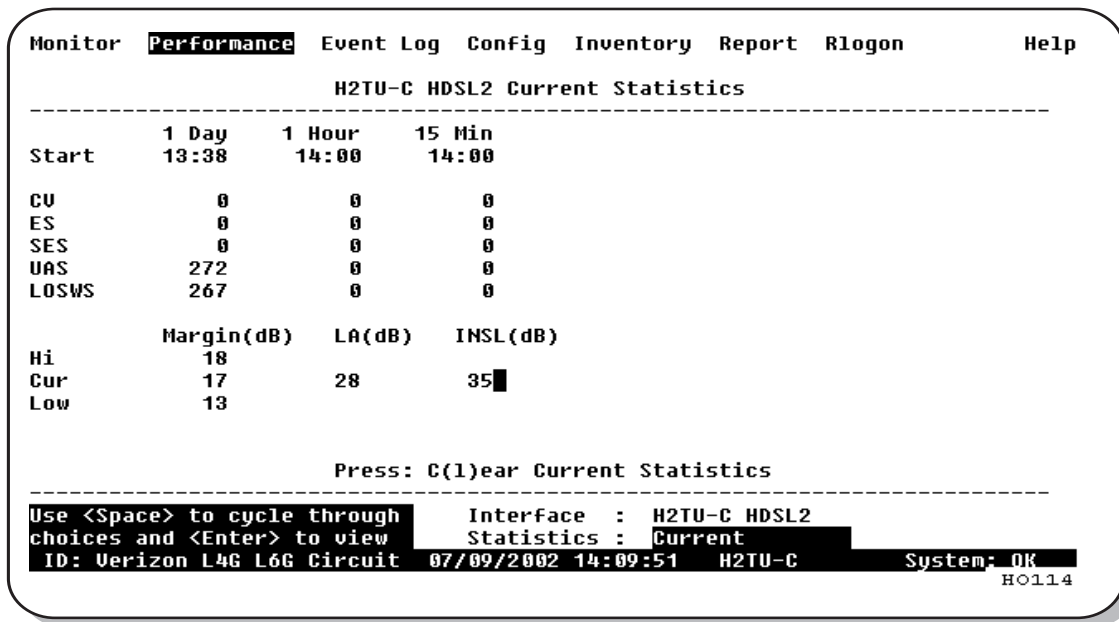

Figure 20. H2TU-C HDSL2 Current Statistics

Table 16. Error Acronyms Used on the HDSL2 Performance History Screens

Error Acronym	Description
CV	Code Violation Total count of HDSL2 CRC errors.
ES	Errored Seconds Seconds with HDSL2 CRC ≥ 1 or LOSW ≥ 1
SES	Severely Errored Seconds Seconds with HDSL2 CRC ≥ 50 or LOSW ≥ 1
UAS	Unavailable Seconds Based on 10 contiguous SES occurrences
LOSWS	Loss of Sync Word Second Seconds with LOSW ≥ 1

USING THE PERFORMANCE SCREENS TO VIEW ALARM DATA

To access the alarm history screens:

- 1 Press **P** to select the Performance screen.
- 2 Press the **SPACEBAR** to select an interface (**H2TU-C DS1**, **H2TU-R DS1**, **H2TU-C HDSL2**, or **H2TU-R HDSL2**), then press **ENTER**.
- 3 Press the **SPACEBAR** until **Alarm History** is selected, then press **ENTER**.
- 4 Press **N** or **P** to page through the alarm history screens.
- 5 Press **L** to clear the selected alarm history screen.

Alarm History at the DS1 Interface

The Alarm History screen reports on a continuous basis the DS1 statistics for the H2TU-C (Figure 21 on page 35) and the H2TU-R (Figure 22 on page 35). The types of alarms reported are described in Table 16 on page 34. Current alarms are shown in reverse video.

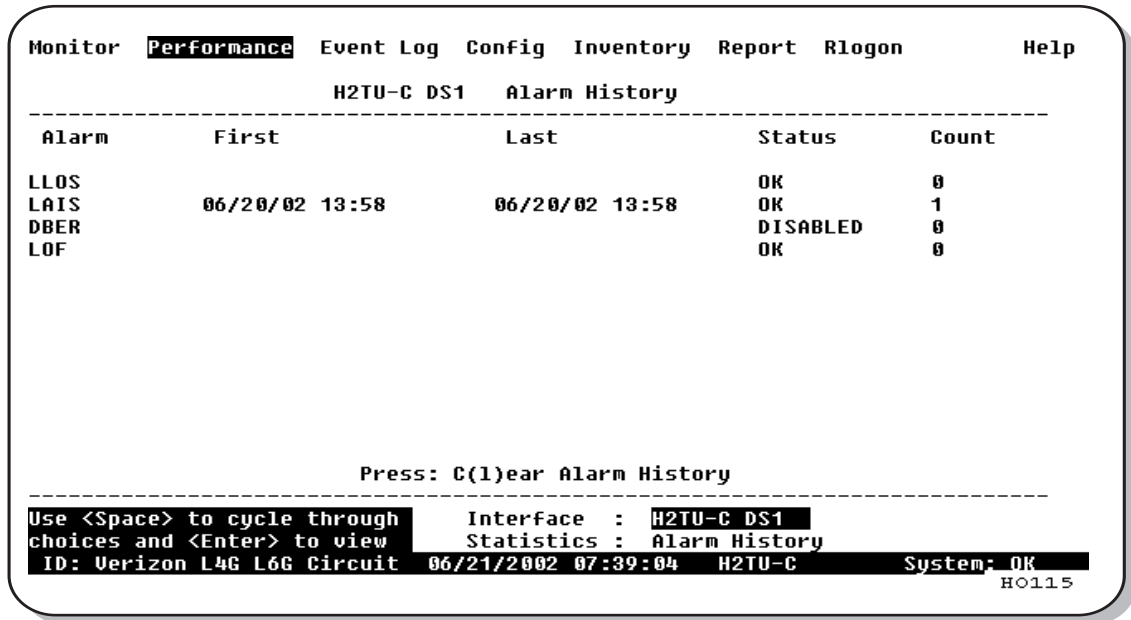

Figure 21. H2TU-C DS1 Alarm History Screen

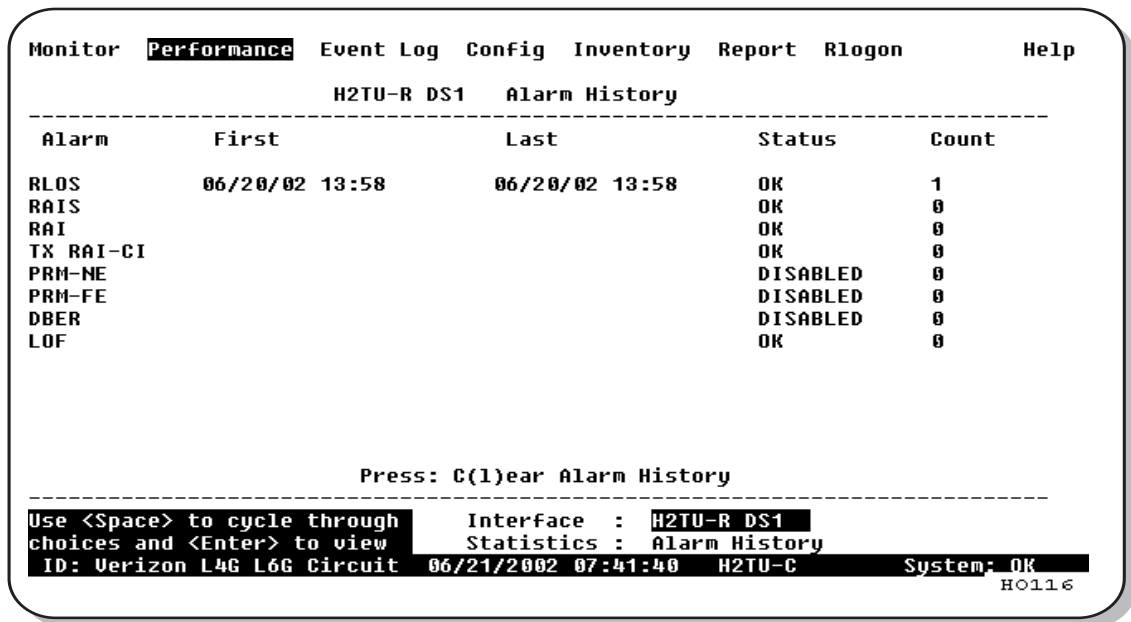

Figure 22. H2TU-R DS1 Alarm History Screen

Table 17. DS1 Alarm Descriptions

Message on Screen	Description
H2TU-C DS1 Alarms (see Figure 21 on page 35)	
LLOS ^(a)	Line (Unit) Loss of Signal—Loss of the H2TU-C DSX-1 input signal.
LAIS	Line Alarm Indication Signal—Indicates an AIS (all ones) pattern is being transmitted from the local DS1 output port. The ALMP option determines whether AIS (default) or LOS is sent toward the CPE.
DBER	Bit Error Rate—The DS1 BER has exceeded the built-in 24-hour threshold limits of approximately 10 ⁻⁶ .
LOF	Loss of Frame—Indicates the incoming DS1 payload does not contain the specific frame pattern, ESF or SF, selected by the FRMG option. Only occurs if the FRMG option is set to SF or ESF.
H2TU-R DS1 Alarms (see Figure 22 on page 35)	
RLOS ^(a)	Remote (Unit) Loss of Signal—Loss of the H2TU-R DS1 input signal.
RAIS	Remote Alarm Indication Signal—Indicates an AIS (all ones) pattern is being received at the H2TU-R DS1 input port. By default AIS-CI ^(b) is sent toward the network. See Figure 26 on page 44.
RAI	Remote RAI - Remote Alarm Indication at the H2TU-R—Indicates an RAI alarm (yellow) from the CPE with errors from the line unit or network.
TX RAI-CI	Transmit RAI-CI - Remote Alarm Indication at the H2TU-R—Upon reception of an RAI (yellow) from the CPE, the H2TU-R sends an RAI-CI toward the network if the network signal received at the H2TU-R is clear. If the network signal is impaired (LOS, AIS, or LOF), then the RAI is passed on to the network unaltered. This is applicable to SF or ESF framing. In an all SF environment, RACI must be enabled to convert SF-RAI to SF-RAI-CI.
PRM-NE	Performance Report Monitoring - Near End—The count of the PRM-NE register at the H2TU-R exceeds the 10 ⁻⁶ BER threshold at 648 events since 12:00:00 AM.
PRM-FE	Performance Report Monitoring - Far End—The count of the PRM-FE register at the H2TU-R exceeds the 10 ⁻⁶ BER threshold at 648 events since 12:00:00 AM.
DBER	Bit Error Rate—The DS1 BER has exceeded the built-in 24-hour threshold limits of approximately 10 ⁻⁶ .
LOF	Loss of Frame—Indicates the incoming DS1 payload does not contain the specific frame pattern, ESF or SF, selected by the FRMG option. Only occurs if the FRMG option is set to SF or ESF.

(a) This is a DS1-specific alarm that also issues a minor alarm (sent to the management unit or the backplane), if enabled.

(b) AIS-CI is a modified AIS alarm pattern. Equipment not suited to detect AIS-CI still detects this signal as an AIS. AIS-CI is sent toward the network indicating that an LOS (RLOS) or AIS (RAIS) has been received from the CPE.

Alarm History at the HDSL2 Interface

The HDSL2 Alarm History screens report alarms at the H2TU-C and the H2TU-R. [Figure 23](#) shows the H2TU-C HDSL2 alarm history. [Table 18](#) describes the alarms that are reported at the H2TU-C or H2TU-R.

```

Monitor  Performance  Event Log  Config  Inventory  Report  Rlogon  Help
-----
                H2TU-C HDSL2 Alarm History
-----
 Alarm      First          Last          Status      Count
-----
 LOSW                               OK          0
 MAL                               OK          0
 LA                               OK          0
 HBER                               OK          0
 SHORT                               OK          0
 GND                               OK          0
 OPEN                               OK          0

                Press: C(1)ear Alarm History
-----
Use <Space> to cycle through  Interface : H2TU-C HDSL2
choices and <Enter> to view   Statistics : Alarm History
ID: Verizon L4G L6G Circuit 06/21/2002 07:43:24 H2TU-C System: OK
                                     HO117

```

Figure 23. H2TU-C HDSL2 Alarm History Screen

Table 18. HDSL2 Alarm Descriptions

Message on Screen	Description
HDSL2 Alarms at the H2TU-C and H2TU-R	
LOSW	Loss of Sync Word—The HDSL2 loop has lost synchronization.
MAL	Margin—The margin on the HDSL2 loop has dropped below the minimum threshold value set for the system.
LA	Loop Attenuation—The attenuation on the HDSL2 loop has exceeded the maximum value set for the HDSL2 loop attenuation threshold. (xxx denotes either TUC or TUR.)
HBER	Block Error Rate—The HDSL2 BER has exceeded the set threshold limits of 10^{-6} or 10^{-7} .
HDSL2 Alarms at the H2TU-C only	
SHORT	A short between the Tip and Ring of the HDSL2 pair is present.
GND	The HDSL2 loop is grounded.
OPEN	A line power open condition is present.

USING THE SYSTEM EVENT LOG TO TRACK EVENTS

The System Event Log screen (Figure 24) displays 100 of the most recent events (most recent event displayed first) and provides the following information:

- Origin tags to identify the source of a Write entry (see “Origin Tags” on page 40)
- Date and time
- Event log messages (see Table 19 on page 39)

To view a running log of system events, press **E** to select the Event Log.

- Press **N** or **P** to page through the event log.
- Press **T** to return to the top of the log.
- Press **L** to clear the event log.

Monitor	Performance	Event Log	Config	Inventory	Report	Rlogon	Help
----- System Event Log (Page 1 of 7) -----							
#	Origin	Date and Time	Entry				
1	Line Unit	06/20/02 13:59:04	DS1 AIS Alarm: End				
2	Remote Unit	06/20/02 13:59:03	DS1 LOS Alarm: End				
3	Remote Unit	06/20/02 13:58:59	DS1 LOS Alarm: Begin				
4	Line Unit	06/20/02 13:58:59	DS1 AIS Alarm: Begin				
5	RU Craft Port	06/20/02 13:58:17	Event Log Reset				
6	- EMPTY -						
7	- EMPTY -						
8	- EMPTY -						
9	- EMPTY -						
10	- EMPTY -						
11	- EMPTY -						
12	- EMPTY -						
13	- EMPTY -						
14	- EMPTY -						
15	- EMPTY -						
Press: (N)ext Page, (P)revious Page, (T)op of Log, C(l)ear Log							
ID: Verizon L4G L6G Circuit 06/21/2002 07:46:15 H2TU-C System: OK							
H0118							

Figure 24. System Event Log

Event Log Messages

Table 19 lists all the possible messages that can be displayed by the System Event Log screen.

Table 19. *Event Log Entry Messages*

Any DS1 Alarm History reset
Any DS1 PM register reset
Any HDSL2 Alarm History reset
Any HDSL2 PM register reset
Any Loop Down (any segment)
Any Loop Up (any segment)
Any provisioning option change: <provisioning mnemonic>: changed from <old> to <new>
CPE DBER alarm (1-day threshold crossed of any PM data except PRM-NE or PRM-FE)
CPE DS1 AIS begins/ends
CPE DS1 LOS begins/ends
CPE PRM-NE BER alarm (<i>at the remote only</i> : 1-day threshold crossed of PRM-NE: trouble on CPE receive)
Current statistics reset
Event Log reset
H2TU-C Power up/down
H2TU-R Power up/down
HDSL2 DC pair open begins/ends on any segment
HDSL2 Ground fault begins/ends on any segment
HDSL2 HBER alarm (threshold crossed) on any segment.
HDSL2 loop attenuation (threshold crossed) on any HDSL2 interface
HDSL2 margin alarm (threshold crossed) on any HDSL2 interface
HDSL2 unavailability begins/ends on any segment
Master zero reset
NTWK DBER alarm (1-day threshold crossed of any PM data)
NTWK DS1 LOS begins/ends
NTWK PRM-FE BER alarm (<i>at the remote only</i> : 1-day threshold crossed of PRM-FE: trouble on NTWK far end)
NTWK DS1 AIS begins/ends
Power Feed Open begins/ends
Power Feed Short begins/ends
RAI begins/ends
TX RAI-CI begins/ends (RAI-CI sent from the remote towards the network)

Origin Tags

The origin tags identify the source of all Write entries and how an event occurred. The exact meaning is dependent on the type of event and the unit reporting the event. A Write entry changes a system parameter or an option setting, but it does not affect circuit status changes, such as alarms. Table 20 lists the various origin tags and their definitions.

Table 20. *Origin Tags*

Origin Tag	Description
Provisioning changes initiated at the line unit (logged on to the line unit)	
LU Craft Port	Event was initiated from the RS-232 craft port located on the H2TU-C front panel.
Management Host	Event was initiated from a host management unit, such as an HMU-319, that sent a command over the management bus on the H2TU-C shelf backplane.
Provisioning changes initiated at the line unit (logged on to the remote unit)	
Line Unit	This generic origin tag can only occur when viewing the Event Log screen at the remote unit. It is a general indication that the event was initiated at the line unit. The Event Log screen must then be viewed at the line unit (through an R logon command) for more specific origin information.
Provisioning changes initiated at the remote unit (logged on to the remote unit)	
RU Front Panel	Event was initiated from the front-panel pushbutton(s) on the H2TU-R.
RU Craft Port	Event was initiated from the RS-232 craft port located on the H2TU-R front panel.
TL1 Command	Event was initiated by a non-intrusive TL1 command embedded in the FDL of the ESF DS1 signal received by the HDSL2 circuit.
Provisioning changes initiated at the remote unit (logged on to the line unit)	
Remote Unit	This generic origin tag can only occur when viewing the Event Log screen at the line unit. It is a general indication that the event was initiated at the remote unit. The Event Log screen must then be viewed at the remote unit (through an R logon command) for more specific origin information.
Loopback commands	
Remote Unit	Implies that the loopback command was initiated at the remote unit by the front-panel pushbuttons, craft port, or in the remote unit's DS1 input payload. A loopback initiated from a terminal would have a Remote Unit tag if the initiating terminal is in a remote logon session.
Line Unit	Implies that the loopback command was initiated at the line unit by the craft port or in the line unit's DSX-1 input payload.
Alarms	
Remote Unit	Indicates that the alarm occurred at the remote unit.
Line Unit	Indicates that the alarm occurred at the line unit. LOSW, SHORT, GND, and OPEN are always tagged as line unit alarms.

USING THE REPORT MENU

The Report menu (Figure 25) provides screens containing status and performance monitoring data for line and remote units which can be downloaded to a file for analysis or future reference. Table 21 on page 42 describes the four types of reports provided by the Report menu.

To select each individual report, do the following:

- 1 Press **O** to select Report menu.
- 2 Press the **SPACEBAR** to select a report type and print mode.
 - Continuous Print Mode generates a non-stop version of the report.
 - Page Mode generates a page-by-page version of the report for easy viewing on the screen.
- 3 Use your terminal emulation software (HyperTerminal or Procomm) to capture the selected report to your printer. Press **ENTER** to generate. (If Page Mode is selected, press the **SPACEBAR** to continue or **ESC** to quit.)
- 4 End the captured report.
- 5 Press **CTRL + R** to refresh the Report menu screen.

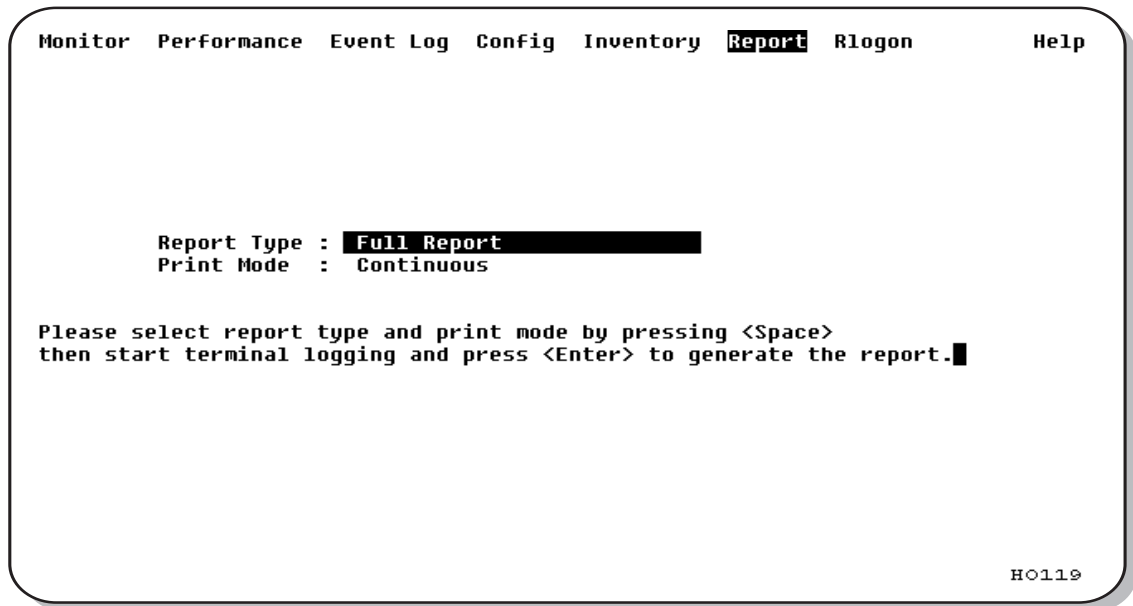

Figure 25. Report Menu - Full Report

Table 21. Report Types

Type	Contains the following information:
Full Report	<ul style="list-style-type: none">• Circuit and unit identifications• Product information• System configuration• Current performance statistics• Alarm history• Performance history• System event log
Short Report	<ul style="list-style-type: none">• Product information• System configuration• Current performance statistics• Circuit and unit identification
System Information Report	<ul style="list-style-type: none">• Circuit and unit identifications• Product information• System configuration
Event Report	<ul style="list-style-type: none">• Circuit and unit identifications• Product information• System event log

TESTING

This section provides information about system alarms, LOS and AIS response, OCT55 test procedure, and loopback testing.

SYSTEM ALARMS

Table 22 provides a summary of the system alarms displayed on the H2TU-C alarm history screens (see “Using the Performance Screens to View Alarm Data” on page 34).

Table 22. System Alarms Summary

Message on Screen	Alarm	Description	To Inhibit
SHORT	Power Feed Short	A short exists between the Tip and Ring of the HDSL2 pair.	Cannot be inhibited.
GROUND	Power Feed Ground	The HDSL2 loop is grounded.	Cannot be inhibited.
OPEN	Power Feed Open	A line power open condition exists.	Cannot be inhibited.
LOSW	Loss of Sync Word	The HDSL2 loop has lost synchronization.	Cannot be inhibited.
LLOS	Line (Unit) Loss of Signal	Loss of the DSX-1 input signal.	Cannot be inhibited.
RLOS	Remote (Unit) Loss of Signal	Loss of the H2TU-R DS1 input signal.	Cannot be inhibited.
LAIS	Line Alarm Indication Signal	Indicates an AIS (unframed all ones) pattern is being received at the H2TU-C DS1 input port.	Cannot be inhibited.
RAIS	Remote Alarm Indication Signal	Indicates an AIS (unframed all ones) pattern is being received at the H2TU-R DS1 input port.	Cannot be inhibited.
TX RAI-CI	Transmit RAI-CI—Remote Alarm Indication at the H2TU-R	Upon reception of an RAI (yellow) from the CPE, the H2TU-R sends RAI-CI toward the network if the network signal received at the H2TU-R is clear. If the network signal is impaired (LOS, AIS, or LOF), then the RAI is passed on to the network unaltered.	Cannot be inhibited.
RAI	Remote RAI—Remote Alarm Indication at the H2TU-R	Indicates an RAI alarm (yellow) from the CPE with errors from the line unit or network.	Cannot be inhibited.
DBER	DS1 Bit Error Rate	The DS1 BER has exceeded the set threshold limits of approximately 10^{-6} .	Select DIS for the DBER system option.
PRM-FE	Performance Report Messaging - Far End	Indicates H2TU-R PRM-FE BER threshold is exceeded.	Set DBER threshold to DIS.
PRM-NE	Performance Report Messaging - Near End	Indicates H2TU-R PRM-NE BER threshold is exceeded.	Set DBER threshold to DIS.
HBER ^(a)	HDSL2 Block Error Rate	The HDSL2 BER has exceeded the set threshold limits of 10^{-6} or 10^{-7} .	Select NONE for the HBER system option.
MAL ^(a)	Margin Alarm	The margin on the HDSL2 loop has dropped below the minimum threshold value set for the system.	Set the Margin Alarm Threshold option to 0 (zero).
LA ^(a)	Loop Attenuation	The attenuation on the HDSL2 loop has exceeded the maximum value set for the HDSL2 loop attenuation threshold.	Set the HDSL2 Loop Attenuation Threshold option to zero.

(a) Only these alarms assert the System Alarm bus on pin H of the card-edge connector if the ALM option is enabled.

Alarm Option for the Digital Loop Carrier Feed

To improve HDSL2 compatibility with the switch-to-protect features used in Digital Loop Carrier (DLC) feeder applications, the H2TU-C has an Alarm Pattern (ALMP) option that allows either AIS or LOS DS1 output payload selection for the following alarms:

- LOSW on any loop
- LOS DS1

Remote LOS and AIS Response

Figure 26 shows the different ways the HDSL2 can respond to the network, depending on the configuration of the TLOS, NLBP, FT1, ALMP, and NAIS configuration options described in Table 5 on page 15 and Table 6 on page 16.

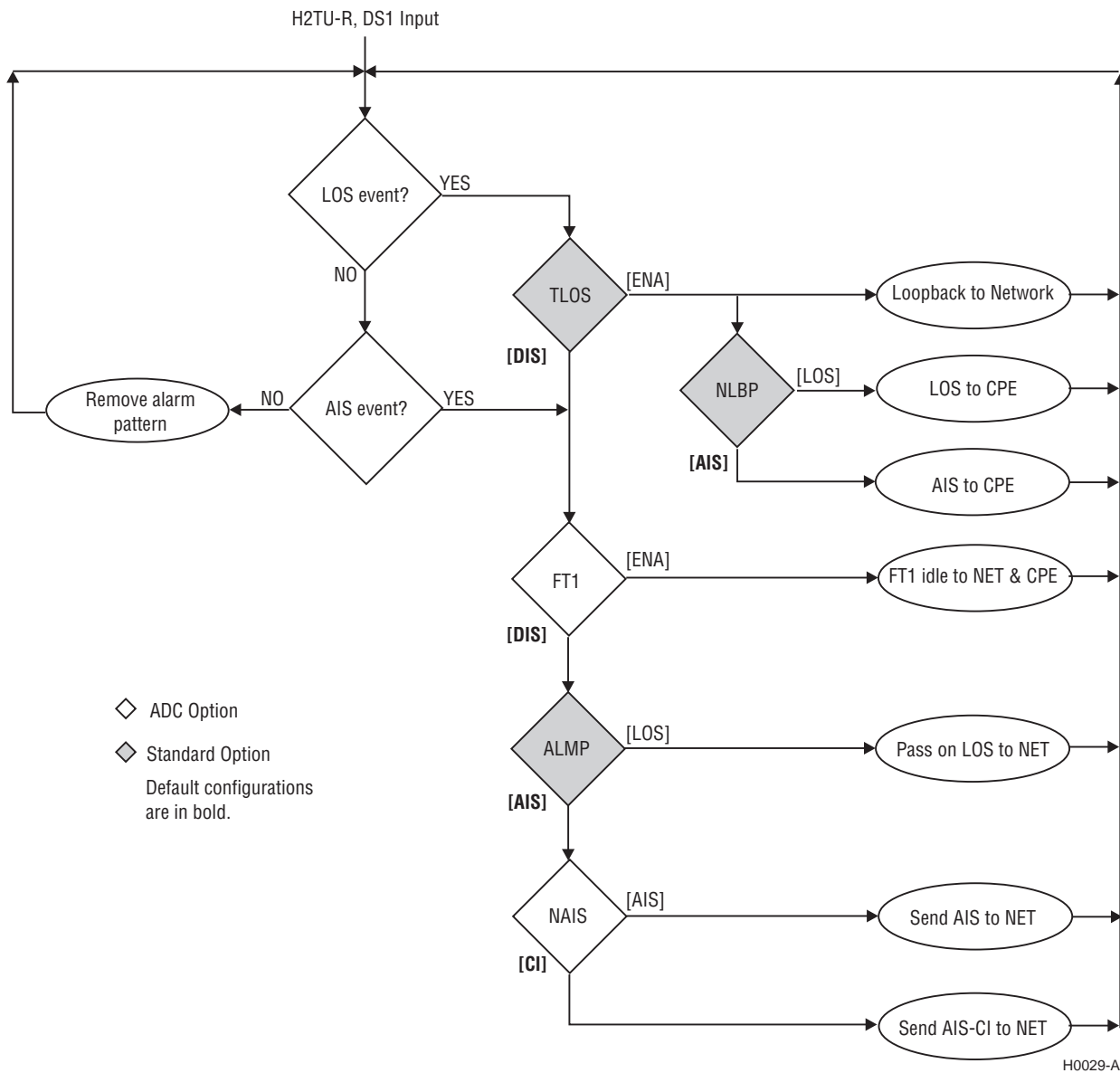

Figure 26. H2TU-R LOS and AIS Response Priorities

OCT55 TEST PATTERN WITH AMI LINE CODE

The OCT55 test pattern can be used in unframed mode to stress the system and verify data integrity. In an SF or ESF framing mode, excessive zero anomalies may occur, which causes the H2TU-C to report ES, SES, and UAS errors according to ANSI T1.231-1997.

LOOPBACK OPERATION

HiGain HDSL2 has a variety of loopback options for analyzing circuit functionality. The loopback signal is transmitted and returned to the sending device for comparison. This allows you to verify the integrity of the HDSL2 channels to the H2TU-C, the H2TU-C DSX-1 interface, and the DS1 channels to the customer.

Loopback commands can be initiated by:

- Entering the loopback code into the test equipment connected to the H2TU-C or H2TU-R.
- Selecting the loopback type from the Monitor menu when connected to the H2TU-C or H2TU-R (see “[Loopback Testing Using a Maintenance Terminal](#)” on page 50).
- Using the loopback pushbuttons (LLB and RLB) on the H2TU-R (see “[Loopback Testing Using Remote Unit Front-Panel Pushbuttons](#)” on page 50).
- Special loopback modes:
 - Generic Mode Loopback (GNLB) commands, including the SmartJack (SMJK) option (see “[GNLB Mode Loopback Commands](#)” on page 46).
 - A3LB Mode Addressable Repeater Loopback commands (see “[A3LB Mode Loopback Commands](#)” on page 46).



HiGain supports multiple loopbacks, but a single loopback is the preferred method.

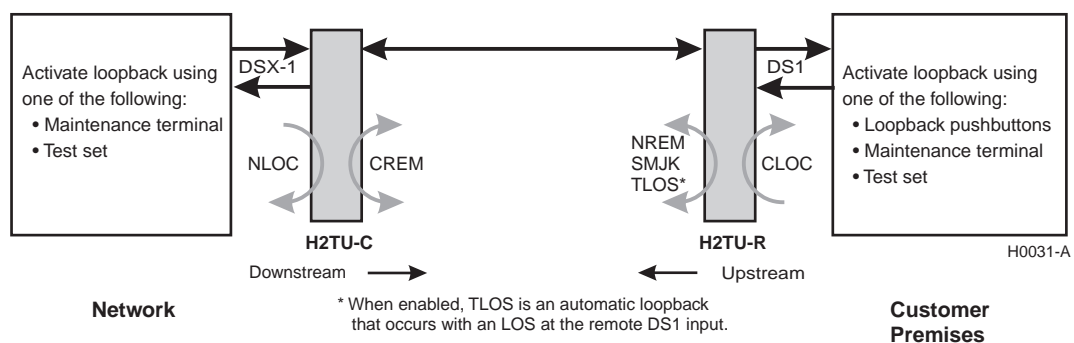

Figure 27. Loopback Summary

SPECIAL LOOPBACK (SPLB) MODE

The HDSL2 system can be configured from the ADC Options menu for one of two SPLB modes, GNLB or A3LB. These modes permit the HDSL2 system to respond to the loopback commands described in the following paragraphs.

GNLB Mode Loopback Commands

The GNLB (Generic Loopback) commands allow the use of inband codes to loop up either NLOC (4-in-7) or NREM (3-in-7) towards the network. Additionally, these inband codes loop up CREM (6-in-7) or CLOC (5-in-7) towards the customer. Either loopup condition can be terminated (looped down) with the 3-in-5, SMJK loopdown code. All inband codes must be present for at least 5 seconds before the HDSL2 system responds. TLOS is a logic loopback caused by loss of the DS1 input from the CI.

Figure 27 on page 45 summarizes the available loopbacks in the system, and Table 23 on page 48 summarizes the HDSL2 generic loopback commands. See “GNLB Test Procedures” on page 48 for the test procedures that apply when using the GNLB Special Loopback Mode.



HiGain systems feature the SmartJack option which can emulate a Network Interface Device (NID) for loopback testing of the HDSL2 circuit. SMJK and NREM loopbacks perform the same functions, but their initiation differs. SMJK indicates that the loopback was initiated by the 2-in-5 inband command. Conversely, NREM is initiated by the 3-in-7 inband command, or by a command issued from the maintenance terminal.

Use the inband commands to enable or disable the SMJK loopback options. The HDSL2 system setting is normally enabled to recognize all inband SmartJack loopback commands.

A3LB Mode Loopback Commands

A3LB loopback commands can be sent by a test set connected to the H2TU-C or H2TU-R. See Table 24 on page 50 for a list of the commands.

A3LB is a special, addressable, repeater loopback mode which is supported by the H2TU-C. This loopback mode provides the HDSL2 system with sophisticated maintenance and troubleshooting tools. A3LB is patterned after the Westell addressable T1 repeater loopbacks.

A3LB supports the additional (1-in-6) SMJK loopback command.



SMJK loopback commands are activated only by inband commands.

LOOPBACK TEST PROCEDURES

The following sections provide step-by-step test procedures for verifying the integrity of the HDSL2 channels at every module location as well as the DS1 channels to the customer and the local DSX-1 interface.

General Troubleshooting Tips

If trouble is encountered on the DSX-1 interfaces of the H2TU-C, verify that the:

- H2TU-C is making a positive connection with its mounting assembly (shelf) connector.
- H2TU-C internal equalizer is set to the correct distance range per [Table 5 on page 15](#). All equalizers should be set to the distance from the DSX-1 to the shelf.

Setting the Loopback Time-Out Option

Before activating any loopback, verify that the Loopback Time-Out option is set to the desired value. [Table 5 on page 15](#) describes this option.

- 1 Log on to the maintenance terminal.
- 2 Press **ESC** to clear the screen, then press **C** to select the Config menu.
- 3 Select **Standard Options**, then **LBTO**.
- 4 Press the **SPACEBAR** to select the LBTO, then press **ENTER**.

Once activated, a loopback stays active until it times out (based on the LBTO setting) or until a loopdown command is executed to terminate the loopback. When a loopback terminates, the display returns to its normal display mode.

All loopbacks can be initiated by inband commands in the DS1 payload. Loopbacks can also be initiated by a command from the HDSL2 system using maintenance screen selections. Therefore, whenever a loopback is active, the method by which it was activated is indicated in the Loopback and Status screens by the annotation HG or PL adjacent to the identified loopback. For example, NREM-HG indicates that the loopback was initiated by the HDSL2 system.

GNLB Test Procedures

Figure 28 on page 49 is a graphical representation of the various loopback configurations with the associated GNLB commands shown. Table 23 summarizes the codes required to execute GNLB loopback commands. All code sequences must be present for at least 5 seconds.

To perform the GNLB loopback test procedure:

- 1 Have the CO tester send the NREM (3-in-7) inband loopup code for 5 seconds. The RLB/LLB LED on the H2TU-R front panel should be green, and the loopback mode should also be identified on the Monitor screen.
- 2 Have the CO tester transmit a DS1 test signal toward the H2TU-C and verify that the returned (looped) signal to the test set is error-free.
- 3 If Step 2 fails, have the CO tester transmit the (3-in-5) inband loopdown code.
- 4 Have the CO tester send the NLOC (4-in-7) inband loopup for 5 seconds. The RLB/LLB LED on the H2TU-R front panel should be yellow, and the loopback mode should also be identified on the Monitor screen.
- 5 Repeat Step 2. If the test passes, the problem is in the downstream direction. If it fails, the problem is in the upstream direction.

Table 23. Summary of HDSL2 Generic Loopback Codes and Activation Methods

Loopback	Code	Description	Method of Activation	
			Test Set	Craft Port
NLOC	1111000 4-in-7	DSX-1 signal is looped back to the network at the H2TU-C.	X	X
NREM	1110000 3-in-7	DSX-1 signal is looped back to the network at the H2TU-R.	X	X
CLOC	1111100 5-in-7	DS1 signal from the customer is looped back to the customer at the H2TU-R.	X	X
CREM	1111110 6-in-7	DS1 signal from the customer is looped back to the customer at the H2TU-C.	X	X
SMJK LpUp (PL) ^(a)	11000 2-in-5	SmartJack Loopup or NID payload (PL) code. Invokes H2TU-R loopback toward network.	X	
SMJK LpUp (ESF-DL) ^(a)	1111-1111-0100-1000	SmartJack Loopup or NID (ESF-DL) code. Invokes H2TU-R loopback toward network.	X	
SMJK LpDn (PL)	11100 3-in-5	SmartJack Loopdown or NID payload (PL) code. Removes SMJK, NLOC, NREM, CLOC, and CREM.	X	
SMJK LpDn (ESF-DL)	1111-1111-0010-0100	SmartJack Loopdown or NID (ESF-DL) code. Removes SMJK, NLOC, NREM, CLOC, and CREM.	X	
SMJK LpUp ^(a)	100000 1-in-6	SmartJack Loopup code from the network. Invokes H2TU-R loopback towards network.	X	
SMJK LpDn	100 1-in-3	SmartJack Loopdown code from the network or customer interfaces. Removes any loopback in the system.	X	

(a) This loopback command is valid only when the SmartJack Loopback (LPBK) option is ENABLED.

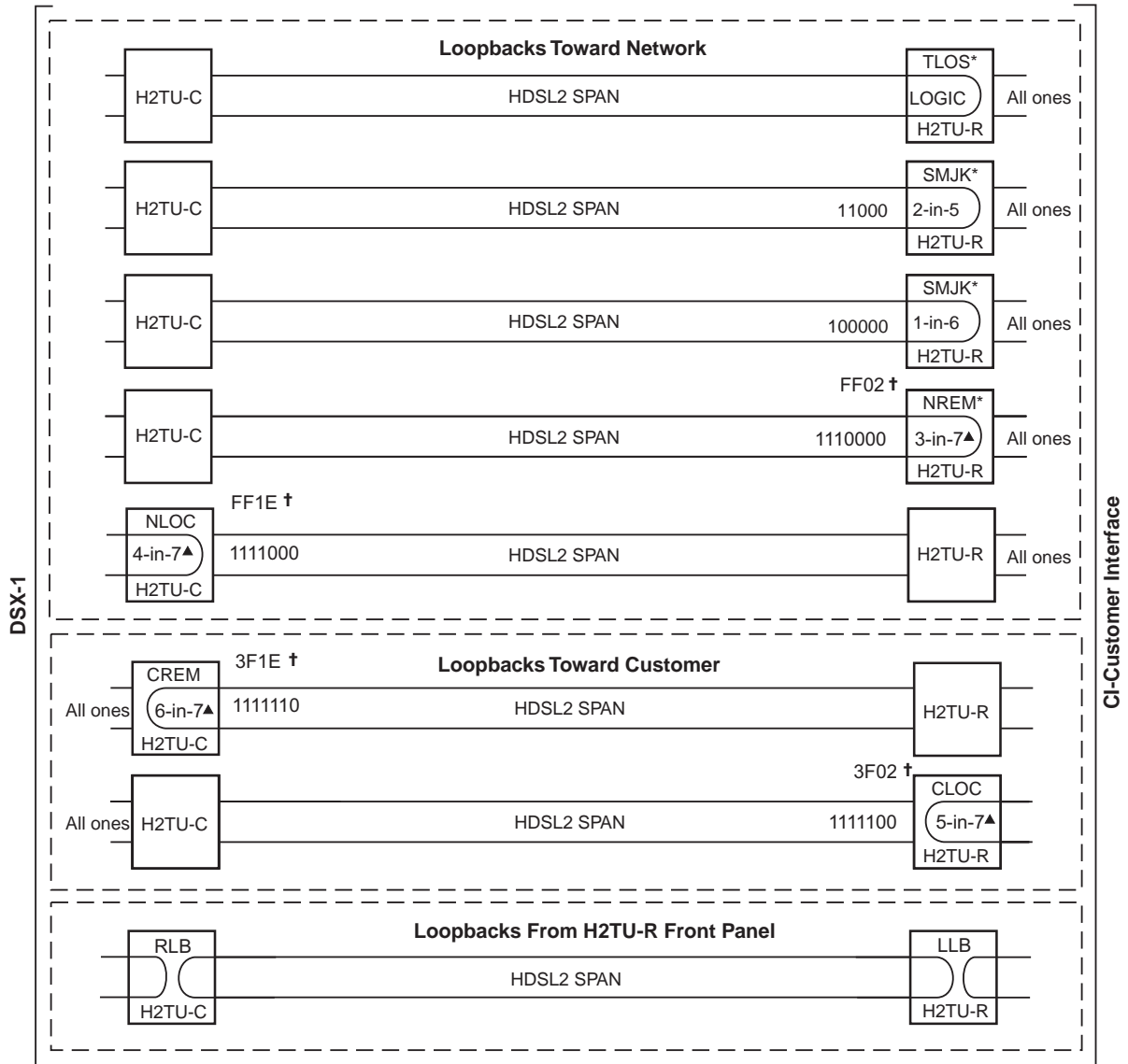

* Set the NLBP option to AIS to send AIS (indicated by an all ones pattern) for any network loopback.
 † A3LB loopback code.
 ▲ GNLB loopback codes.

H0033-A

Figure 28. Loopback Modes

A3LB Test Procedures

Figure 28 on page 49 is a graphical representation of the various loopback configurations with the associated A3LB commands shown.

The H2TU-C can be looped back by sending the Addressable Office Repeater (AOR) LPBK activation code 1111-1111-0001-1110 (FF1E) for at least 5 seconds. This causes the H2TU-C to enter the NLOC state. The Loopback Time-Out setting determines the duration of this loopback unless it is overridden by the reception of a second identical 16-bit loopup command before the timer expires. When this time-out override state exists, the only method to loop the H2TU-C down is to issue one of the three loopdown commands listed in Table 24. The automatic time-out mode is restored during subsequent loopback sessions.

Table 24 on page 50 summarizes the codes required to execute Addressable 3 (A3LB) repeater loopback commands. All code sequences must be present for at least 5 seconds.

Table 24. Addressable Repeater Loopback Commands (A3LB)

Name	Binary Code ^(a) (Hexadecimal Equivalent)	Description
NLOC	1111-1111-0001-1110 (FF1E)	H2TU-C loopup from NI
CREM	0011-1111-0001-1110 (3F1E)	H2TU-C loopup from CI
NREM	1111-1111-0000-0010 (FF02)	H2TU-R loopup from NI
CLOC	0011-1111-0000-0010 (3F02)	H2TU-R loopup from CI
SMJK	11000-11000-11000 ...	H2TU-R loopup from NI ^(b)
SMJK	100000 100000 100000 ...	H2TU-R loopup from N ^(b)
SMJK	1111-1111-0100-1000 (FF48)	H2TU-R loopup from NI (ESF-DL) ^(b)
Loopdown	11100-11100-11100 ...	H2TU-C and H2TU-R loopdown from NI OR CI
Loopdown	100-100-100 ...	H2TU-C and H2TU-R loopdown from NI OR CI
Loopdown	1111-1111-0010-0100 (FF24)	H2TU-C and H2TU-R loopdown from NI OR CI (ESF-DL)

(a) The leftmost bit arrives first in all sequences. The detection algorithm functions reliably with a random 10^{-3} Bit Error Ratio (BER) on the facility. The entire arming and loopback sequence can also be initiated at the remote H2TU-R location.

(b) This loopback command is only valid when the SmartJack Loopback (LPBK) option is configured to ENABLED.

Loopback Testing Using a Maintenance Terminal

To activate a loopback session using a maintenance terminal:

- 1 Press **ESC** to clear the Config menu, then press **M** to select the Monitor screen.
- 2 Press the **SPACEBAR** to select the **NLOC**, **NREM**, **CLOC**, or **CREM** loopback, then press **ENTER** to activate the loopback. Press **Y** to confirm.
- 3 To manually terminate the loopback, press the **SPACEBAR** to select **LPDN**, then press **ENTER**. Press **Y** to confirm.

Loopback Testing Using Remote Unit Front-Panel Pushbuttons

On the H2TU-R front panel, press the appropriate pushbutton for 5 or more seconds:

- LLB—Activates a dual loopback at the H2TU-R (NREM + CLOC).
- RLB—Activates a dual loopback at the H2TU-C (NLOC + CREM).

To loopdown any active loopback in the system, including SMJK and TLOS, press the LLB or RLB pushbutton for 5 or more seconds. To activate a dual loopback after a loopdown, again press the LLB or RLB pushbutton for 5 or more seconds.

Programmable DSX-1 Test Jacks

The H2TU-C front panel DSX-1 LINE jacks can be configured for intrusive test access of the signal to/from the network or to/from the customer (default setting). The front panel DSX-1 MON jacks always provide non-intrusive monitoring of the DSX-1 signal to and from the customer.



Use of the DSX-1 LINE jacks interrupt normal traffic flow.

When performing intrusive testing to the customer, configure the DS1 Test Jack direction for "CPE." Connect the DS1 Test Equipment to the DSX-1 LINE jacks as shown in [Figure 29 on page 51](#). The signal from the network is disconnected and no DS1 signal is transmitted to the network.

When performing intrusive testing to the network, configure the DS1 Test Jack direction for "NET." Connect the DS1 Test Equipment to the DSX-1 LINE jacks as shown in [Figure 30 on page 51](#). An LLOS is reported at the H2TU-C and an AIS or LOS is sent to the customer.

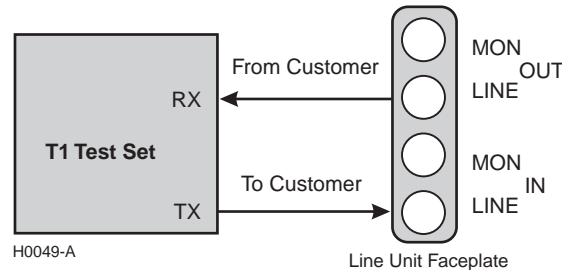

Figure 29. DSX-1 Testing Towards Customer

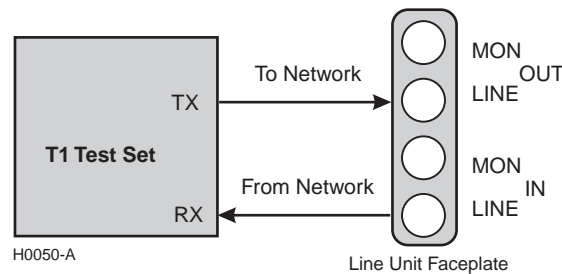

Figure 30. DSX-1 Testing Towards Network

To configure the DSX-1 LINE jacks for test access to the network or customer:

- 1 Press **C** to select the Config menu.
- 2 Use the **↑** and **↓** arrow keys to select **DS1 Test Jack** ([Figure 31](#)), then press **ENTER**.
- 3 Use the **SPACEBAR** to select network access (**NET**) or customer access (**CPE**), then press **ENTER**.



Changes in the DS1 Test Jack setting are reported in the event log.

The DS1 Test Jack setting remains for as long as the H2TU-C is receiving power. The H2TU-C reverts to the default CPE setting when power is cycled.

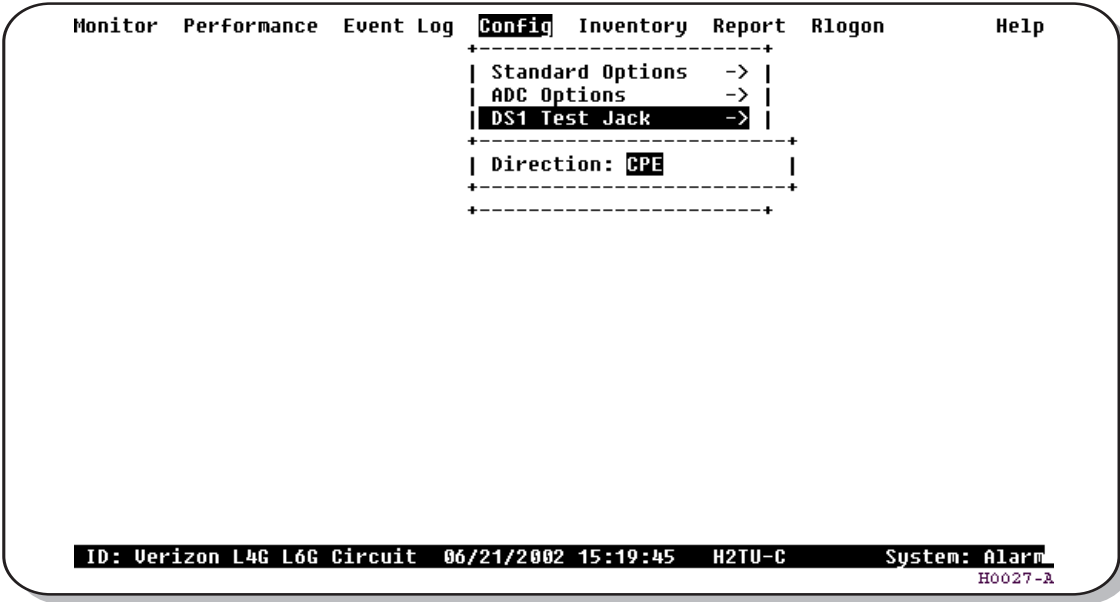

Figure 31. Config Menu - DS1 Test Jack

APPENDIX A - SPECIFICATIONS

Power

HDSL2 Span Voltage	0 or -180 \pm 5 Vdc
CO Supply	-48 Vdc nominal (-42.5 Vdc to -56.5 Vdc) See “Power Consumption” and “Maximum Power Dissipation” and “Maximum Current Drain” on page 54.
Electrical Protection	Secondary surge and power cross protection on HDSL2 ports. Requires external primary protection.
Fusing	Internal; connected to “FUSE ALARM” output on pin 10

Environmental

Operating Temperature	-40°F to +149°F (-40°C to +65°C)
Operating Humidity	5% to 95% (non-condensing)

Physical

Height	4.750 in. (12.10 cm)
Width	0.625 in. (1.59 cm)
Depth	10 in. (25.4 cm)
Weight	0.5 lb (.23 kg)
Mounting	3192 mechanics shelves

HDSL2

Line Rate	1.552 Mbps Overlapped Pulse Amplitude Modulation Transmission with Interlocking Spectra (OPTIS)
Transmission	Full duplex
Media	One non-loaded, copper, two-wire cable pair
Output	+16.8 dBm \pm 0.5 dB at 135 Ω (0-450 kHz) at CO side; +16.5 dBm \pm 0.5 dB at 135 Ω (0-350 kHz) at remote side
Line Impedance	135 Ω
Maximum Insertion Loss	35 dB at 196 kHz
Maximum Loop Attenuation	28 dB
Start-up Time	30 sec. typical, 1 min. maximum per span

DSX-1

DSX-1 Line Impedance	100 Ω
DSX-1 Pulse Output	6 V ^{pk-pk} pre-equalized for 0-655 feet of ABAM cable
DSX-1 Input Level	+1.5 to -7.5 dB DSX

System

One-way DS1 Delay	<400 μ s
Wander (Looped)	Meets MTIE T1.101 requirements
Wideband Jitter (Looped)	0.2 UI maximum
Narrowband Jitter (Looped)	0.1 UI maximum

POWER CONSUMPTION

The three most important power parameters of an H2TU-C are its maximum power consumption, maximum power dissipation, and maximum current drain.

Table 25 describes line-powered and locally powered circuits on 9 kft, 26 AWG loops.

Table 25. H2TU-C Power Parameters

	-48 Vdc Power Consumption (Watts)	Heat Dissipation (Watts)	-42.5 Vdc Current (mA)
Remote Power Source	Maximum	Maximum	Maximum
Line-powered	12.0	7.0	286.0
Locally powered	8.6	6.7	205.0

MAXIMUM POWER DISSIPATION

The maximum power dissipation measures the power that is converted into heat and contributes to the total heat generated in the space around the unit. It is used to determine the maximum number of fully loaded shelves per bay that does not exceed the maximum allowable power dissipation density in watts per square foot to comply with GR-63.

In COs, the maximum power dissipation for open-faced, natural convection-cooled mountings is limited to 134.7 watts per square foot per GR-63-CORE. Use this limit and the parameters in Table 25 to determine the maximum number of H2TU-C circuits that can occupy one CO bay.



This is a worst case situation since it assumes the entire CO is subjected to the maximum power density. More favorable conditions would permit increasing the number of shelves per bay without jeopardizing the CO thermal integrity.

The thermal loading limitations imposed when using the H2TU-C in a Controlled Environmental Vault (CEV) or other enclosures are determined by applying its power parameters to the manufacturer's requirements for each specific housing.

The -48 Vdc Power Consumption is the maximum total power that the H2TU-C consumes or draws from the shelf power source. This parameter is needed when the H2TU-C is in a location remote to the CO it is serving. It determines the battery capacity required to maintain an 8-hour standby battery reserve for emergency situations. Battery capacity, therefore, limits the maximum number of line units which can be installed in a remote enclosure. Use the data in Table 25 above to perform this analysis.

MAXIMUM CURRENT DRAIN

The maximum current drain is the maximum current drawn from the shelf power supply when it is at its minimum voltage (-42.5 Vdc). This determines the shelf fusing requirements. Use the -42.5 Vdc current data in Table 25 above to determine the shelf fusing requirements for your particular H2TU-C applications.

LOOP ATTENUATION

Each loop has no more than 35 dB of insertion loss at 196 kHz, with driving and terminating impedances of 135Ω, as shown in Table 26 below. This is equivalent to no more than 28 dB loop attenuation.

Table 26. HDSL2 Reach Chart

Cable Gauge	Insertion Loss ^(a) at 196 kHz (dB/kft)	Loop Attenuation (dB/kft)	Maximum Reach (kft)	Ω per kft
26/0.4 mm	3.88	3.1	9	83
24/0.51 mm	2.84	2.2	12	52
22/0.61 mm	2.18	1.7	16	32
19/0.91 mm	1.54	1.2	23	16

(a) Insertion Loss = 1.25 times loop attenuation

H2TU-C CARD-EDGE CONNECTOR

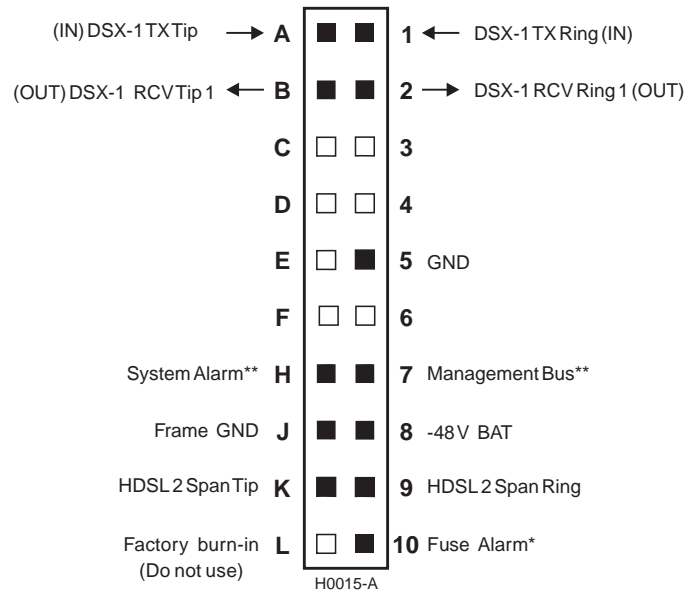

* Fuse Alarm
Normal = Floating (0 to -60 Vdc Maximum)
Activated = -48 Vdc, 10mA Maximum

** System Alarm and
Management Bus (reserved)

*** Active pins are solid black.

Figure 32. H2TU-C Card-Edge Connector

Network Management Control Bus

The H2TU-C provides a Network Management Control Bus on pin 7 of the card-edge connector. This allows the various ADC Management System protocols to manage the H2TU-C through the HMU-319 HiGain Management Unit.



Some H2TU-C features are affected when it is under management. Consult the management unit practice for further information.

Fuse Alarm

Pin 10 on the card-edge connector is a Fuse Alarm that is driven to -48 Vdc whenever its onboard fuse opens.

System Alarm Output Pin

Pin H on the card-edge connector, shown in [Figure 32 on page 55](#), is the H2TU-C System Alarm output pin. The following notes apply to pin H:

- Pin H replaces the Local Loss of Signal (LLOS) on standard high-density (3192) repeaters.
- The normally floating output of pin H can connect to pin 1 of the 1184 or 3192-9F Alarm Card in position 29 of the high density (HD) shelf.
- The H2TU-C forces pin H to +5 Vdc (maximum of 10 mA) for a system alarm condition. Pin H then remains at +5 Vdc for the duration of the alarm condition.
- If the Wescom 1184 Alarm Card is installed in the shelf, its LOS LED lights for every MNRALM.
- The H2TU-C Status LED flashes red for the duration of a system alarm condition.
- Setting the ALM option to DIS only prevents the system alarm bus on pin H from being activated for a system alarm event. The Status LED still flashes red and the ALRM message still displays.
- “[System Alarms](#)” on [page 43](#) describes the system alarms that activate pin H.



Pin H must never be taken above +5 Vdc or below -60 Vdc.

CRAFT PORT

Figure 33 shows the pinout for the craft port connector and its connection to a DB-9 or DB-25 connector on a maintenance terminal.

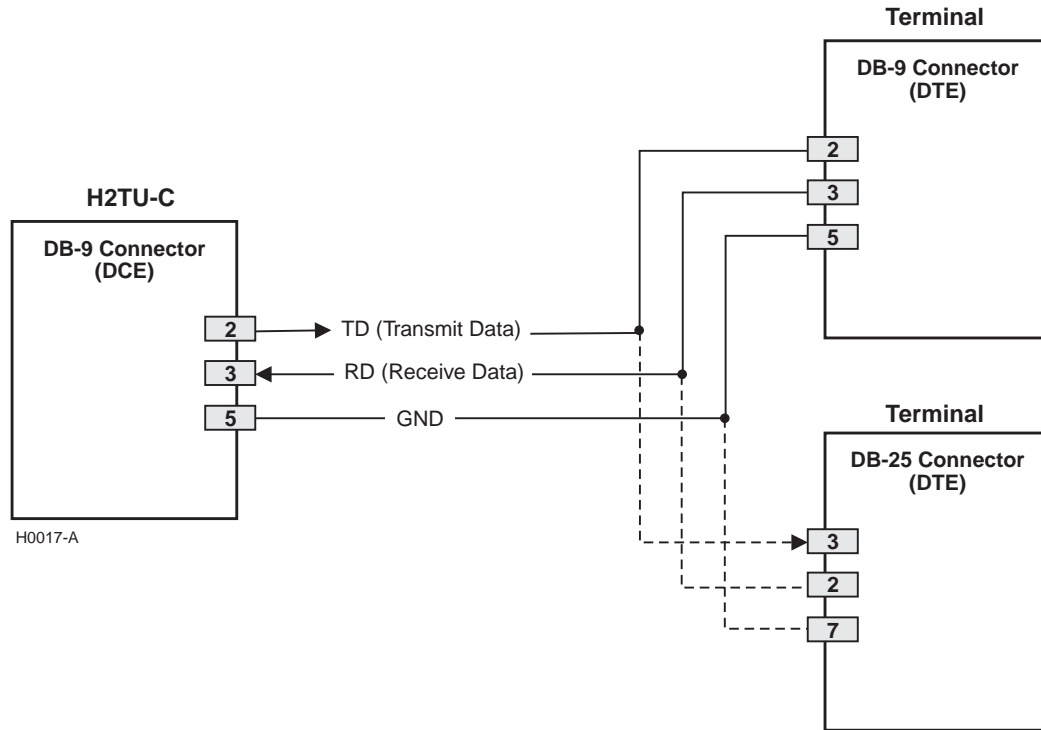

Figure 33. RS-232 Craft Port Pinouts

APPENDIX B - FUNCTIONAL OPERATION

ADC HDSL2 technology provides full-duplex services at standard DS1 rates over copper wires between an H2TU-C and an H2TU-R, which comprise one HDSL2 system. ADC systems use ADC Overlapped Pulse Amplitude Modulation Transmission with Interlocking Spectra (OPTIS) transceiver systems to establish a full-duplex, 1.552 kbps data channel between an H2TU-C and a remotely located H2TU-R.

Figure 34 shows a block diagram of the H2TU-C. The H2TU-C receives a 1.544 Mbps DSX-1 data stream from the DSX-1 digital cross-connect interface. The H2TU-C contains a DS1 frame synchronizer controlled by an 8-bit microprocessor that determines the type of framing on the DS1 stream. The H2TU-C synchronizes to the type of framing detected. The H2TU-C recognizes SuperFrame (SF), including D4 or Extended SuperFrame (ESF).

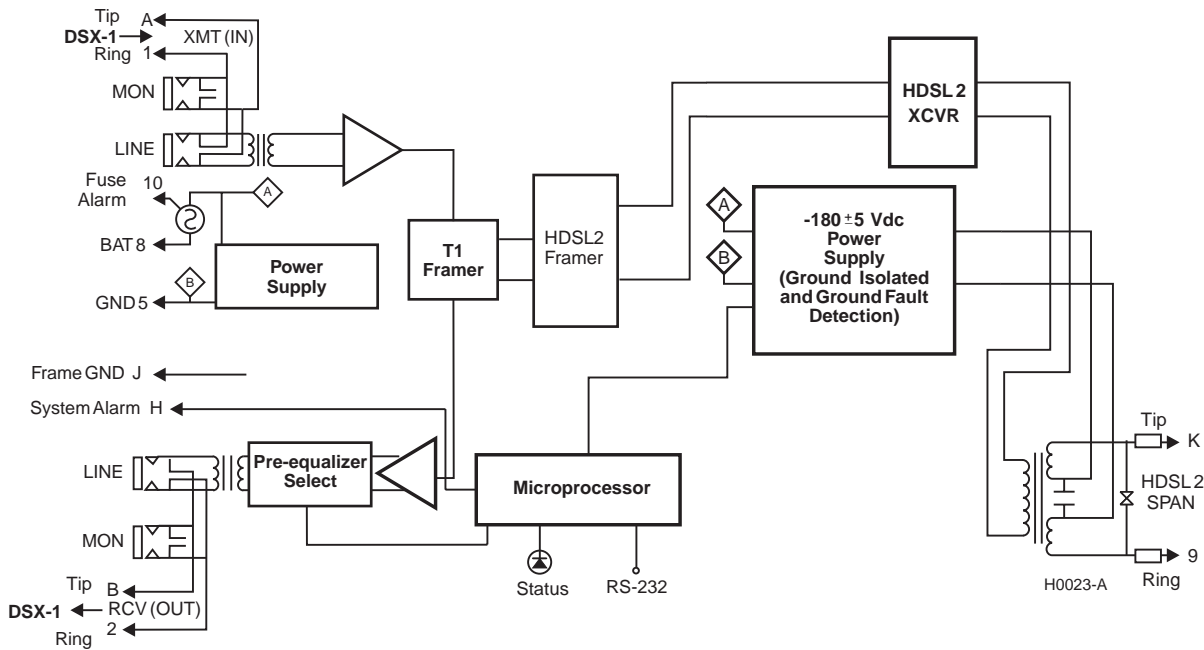

Figure 34. H2TU-C Block Diagram

TIMING

The low loop wander (0.5 UI max) of an H2TU-C, when used with remote units, allows the circuit to be used in all critical timing applications, including those that are used to transport Stratum 1 timing.

GROUND FAULT DETECTION

The H2TU-C has a Ground Fault Detection (GFD) circuit which detects a ground or a resistive path to ground on any wire of the HDSL2 loop. This makes the product compliant with the Class A2 requirements of GR-1089.

APPENDIX C - COMPATIBILITY

The HiGain system uses HDSL2 transmission technology as recommended by ANSI committee in compliance with the ANSI T1.418-2000 HDSL2 standards. HiGain HDSL2 complies with GR-63-CORE, TR-TSY-000499, and GR-1089-CORE.

The H2TU-C is designed to mount in the following shelves with 3192 mechanics:

- ADC HiGain HMS-317 (28-slot, 23-inch shelf)
- ADC HiGain HHS-319 (3-slot, 19-inch horizontal shelf)
- ADC HiGain HMS-308 (8-slot remote enclosure)
- Charles Ind. #3192 (28-slot connectorized)
- Charles Ind. #3192-WR (28-slot wire wrap)
- Charles Ind. #343-00 (12- to 14-slot wire wrap)
- Charles Ind. #319-02 (22-slot connectorized)
- Charles Ind. #319-04 (22-slot wire wrap)
- Charles Ind. #340-00 (9-slot to 11-slot wire wrap)
- Larus #1185 (28-slot connectorized)



Charles Ind. 343-00 and 340-00 shelves do not support the H2TU-C System Alarm output on pin H. Also, if slots 1 and 2 of these shelves were wired for the 3408 Fault Locate unit, they must be rewired to accept the H2TU-C.

APPENDIX D - PRODUCT SUPPORT

ADC Customer Service Group provides expert pre-sales and post-sales support and training for all its products. Technical support is available 24 hours a day, 7 days a week by contacting the ADC Technical Assistance Center.

Sales Assistance

800.366.3891 extension 73000
(USA and Canada)
952.917.3000
Fax: 952.917.3237

- Quotation Proposals
- Ordering and Delivery
- General Product Information

Systems Integration

800.366.3891, extension 73000 (USA and Canada)
952.917.3000

- Complete Solutions (from concept to installation)
- Network Design and Integration Testing
- System Turn-Up and Testing
- Network Monitoring (upstream or downstream)
- Power Monitoring and Remote Surveillance
- Service/Maintenance Agreements
- Systems Operation

ADC Technical Assistance Center

800.638.0031
714.730.3222
Fax: 714.730.2400
Email: wsd_support@adc.com

- Technical Information
- System/Network Configuration
- Product Specification and Application
- Training (product-specific)
- Installation and Operation Assistance
- Troubleshooting and Repair/Field Assistance

Online Technical Support

- www.adc.com/Knowledge_Base/index.jsp

Online Technical Publications

- www.adc.com/library1/

Product Return Department

800.366.3891 ext. 73748 or
952.917.3748
Fax: 952.917.3237
Email: repair&return@adc.com

- ADC Return Material Authorization (RMA) number and instructions must be obtained before returning products.

All telephone numbers with an 800 prefix are toll-free in the USA and Canada.

APPENDIX E - ABBREVIATIONS

A

ACON:	Auto Conversion of DS1 frame
AIS:	Alarm Indication Signal
AIS-CI:	Alarm Indication Signal-Customer Installation
AOR:	Addressable Office Repeater
AUTO:	Auto-Framing Mode
AWG:	American Wire Gauge

B

BER:	Bit Error Rate
BPV:	Bipolar Violation
BPVT:	Bipolar Violation Transparency

C

CLEI:	Common Language Equipment Identifier
CO:	Central Office
CONV:	Conversion
CREM:	Customer Remote Loopback
CV:	Code Violation
CV-L:	Code Violation - Line
CV-P:	Code Violation - Path

D

DBER:	DS1 BER
DDS:	Digital Data Service
DIS:	Disabled
DL:	Data Link
DLC:	Digital Loop Carrier
DSO:	Digital Signal, Level 0

E

ECI:	Equipment Catalog Item
ENA:	Enabled
ESD:	Electrostatic Discharge
ESF:	Extended SuperFrame
ES-L:	Errored Seconds - Line
EXZ:	The occurrence of 8 consecutive zeroes for B8ZS or 16 for AMI.

F

FCON:	Frame Conversion
--------------	------------------

FDL:	Facility Data Link
FE:	Far End
FT1:	Fractional T1

G

GFD:	Ground Fault Detection
GNLB:	Generic Loopback

H

H2TU-R:	HiGain HDSL2 Remote Unit
HCDS:	High Capacity Digital Service

I

INSL:	Insertion Loss
--------------	----------------

L

LA:	Loop Attenuation
LED:	Light Emitting Diode
LOF:	Loss of Frame
LOS:	Loss of Signal
LOSW:	Loss of Sync Word
LPF:	Line Power Feed

M

MSEC:	Monitored Seconds
--------------	-------------------

N

NE:	Near End
NI:	Network Interface
NID:	Network Interface Device
NIU:	Network Interface Unit
NLOC:	Network Local Loopback
NMA:	Network Management and Administration
NPRM:	Network Performance Report Messaging
NREM:	Network Remote Loopback
NVRAM:	Non-Volatile Random Access Memory

O

OOF:	Out-of-Frame
OPTIS:	Overlapped PAM Transmission with Interlocking Spectra

P

- PBOC:** Power Back Off - Customer
PBON: Power Back Off - Network
PDVS: Pulse Density Violation Seconds
PL: Payload Loopback Command
PRM: Performance Report Messaging
PRM-FE: Performance Report Messaging - Far End
PRM-NE: Performance Report Messaging - Near End

S

- SES:** Severely Errored Seconds
SES-L: Severely Errored Seconds - Line
SES-P: Severely Errored Seconds - Path
SF: SuperFrame
SMJK: SmartJack
SPRM: Supplemental Performance Report Messaging

T

- TLOS:** Transmit Loss of Signal

U

- UAS-L:** Unavailable Seconds - Line
UAS-P: Unavailable Seconds - Path

CERTIFICATION AND WARRANTY

FCC CLASS A COMPLIANCE

This equipment has been tested and found to comply with the limits for a Class A digital device, pursuant to Part 15 of the FCC Rules. These limits are designed to provide reasonable protection against harmful interference when the equipment is operated in a commercial environment. This equipment generates, uses, and can radiate radio frequency energy and, if not installed and used in accordance with the instruction manual, may cause harmful interference to radio communications. Operation of this equipment in a residential area is likely to cause harmful interference in which case the user will be required to correct the interference at his own expense.

LIMITED WARRANTY

ADC DSL Systems, Incorporated (“ADC”) warrants that, for a period of sixty (60) months from the date of shipment, the hardware portion of its products will be free of material defects and faulty workmanship under normal use. ADC’s obligation, under this warranty, is limited to replacing or repairing, at ADC’s option, any such hardware product which is returned during the 60-month warranty period per ADC’s instructions and which product is confirmed by ADC not to comply with the foregoing warranty.

ADC warrants that, for a period of 90 days from the date of purchase, the software furnished with its products will operate substantially in accordance with the ADC published specifications and documentation for such software. ADC’s entire liability for software that does not comply with the foregoing warranty and is reported to ADC during the 90-day warranty period is, at ADC’s option, either (a) return of the price paid or (b) repair or replace of the software. ADC also warrants that, for a period of thirty (30) days from the date of purchase, the media on which software is stored will be free from material defects under normal use. ADC will replace defective media at no charge if it is returned to ADC during the 30-day warranty period along with proof of the date of shipment.

The transportation charges for shipment of returned products to ADC will be prepaid by the Buyer. ADC will pay transportation charges for shipment of replacement products to Buyer, unless no trouble is found (NTF), in which case the Buyer will pay transportation charges.

ADC may use reconditioned parts for such repair or replacement. This warranty *does not* apply to any product which has been repaired, worked upon, or altered by persons not authorized by ADC or in ADC’s sole judgment has been subjected to misuse, accident, fire or other casualty, or operation beyond its design range.

Repaired products have a 90-day warranty, or until the end of the original warranty period—whichever period is greater.

ADC DISCLAIMS ALL OTHER WARRANTIES, EITHER EXPRESS OR IMPLIED, INCLUDING BUT NOT LIMITED TO IMPLIED WARRANTIES OF MERCHANTABILITY AND FITNESS FOR A PARTICULAR PURPOSE, WITH RESPECT TO ITS PRODUCTS AND ANY ACCOMPANYING WRITTEN MATERIALS. FURTHER, ADC DOES NOT WARRANT THAT SOFTWARE WILL BE FREE FROM BUGS OR THAT ITS USE WILL BE UNINTERRUPTED OR REGARDING THE USE, OR THE RESULTS OF THE USE, OF THE SOFTWARE IN TERMS OF CORRECTNESS, ACCURACY, RELIABILITY OR OTHERWISE.

MODIFICATIONS

Any changes or modifications made to this device that are not expressly approved by ADC DSL Systems, Inc. voids the user’s warranty. All wiring external to the products should follow the provisions of the current edition of the National Electrical Code.

SAFETY STANDARDS COMPLIANCE

The equipment has been tested and verified to comply with the applicable sections of the following standards:

- GR 63-CORE - Network Equipment-Building System (NEBS) Requirements
- GR 1089-CORE - Electromagnetic Compatibility and Electrical Safety
- Binational standard, [UL-1950/CSA C22.2 No. 950-95](#): Safety of Information Technology Equipment

For technical assistance, refer to “Appendix D - Product Support” on page 60.

ADC DSL Systems, Inc.

14402 Franklin Avenue
Tustin, CA 92780-7013

Tel: 714.832.9922

Fax: 714.832.9924

Technical Assistance

Tel: 800.638.0031

Tel: 714.730.3222

Fax: 714.730.2400



DOCUMENT: LTPH-UM-1167-01



1237644

