

# USER MANUAL



**H2TU-C-202 List 2F Line Unit**  
Product Catalog: H2TU-C-202-L2F  
CLEI: VACHZW8G

## Revision History of This Manual

To order copies of this document, use document catalog number LTPH-UM-1072-03.

Revision	Release Date	Revisions Made
1	December 12, 2001	Initial release.
2	October 25, 2002	Update specifications for loop attenuation and insertion loss.

### Copyright

*October 25, 2002*

© 2002 ADC DSL Systems, Inc. All rights reserved.

### Trademark Information

*ADC is a registered trademark of ADC Telecommunications, Inc. HiGain is a registered trademark of ADC DSL Systems, Inc. No right, license, or interest to such trademarks is granted hereunder, and you agree that no such right, license, or interest shall be asserted by you with respect to such trademark. Other product names mentioned in this practice are used for identification purposes only and may be trademarks or registered trademarks of their respective companies.*

### Disclaimer of Liability

*Information contained in this document is company private to ADC DSL Systems, Inc., and shall not be modified, used, copied, reproduced or disclosed in whole or in part without the written consent of ADC.*

*Contents herein are current as of the date of publication. ADC reserves the right to change the contents without prior notice. In no event shall ADC be liable for any damages resulting from loss of data, loss of use, or loss of profits, and ADC further disclaims any and all liability for indirect, incidental, special, consequential or other similar damages. This disclaimer of liability applies to all products, publications and services during and after the warranty period.*

## USING THIS MANUAL

The following conventions are used in this manual:

- Monospace type indicates screen text.
- Keys you press are indicated by small icons such as **Y** or **ENTER**. Key combinations to be pressed simultaneously are indicated with a plus sign as follows: **CTRL** + **ESC**.
- Items you select are in **bold**.
- Three types of messages, identified by icons, appear in text.



**Notes contain information about special circumstances.**



**Cautions indicate the possibility of personal injury or equipment damage.**



**The Electrostatic Discharge (ESD) symbol indicates that a device or assembly is susceptible to damage from electrostatic discharge.**

For a list of abbreviations used in this document, refer to [“Appendix E - Abbreviations”](#) on page 69.

## INSPECTING SHIPMENT

Upon receipt of the equipment:

- Unpack each container and inspect the contents for signs of damage. If the equipment has been damaged in transit, immediately report the extent of damage to the transportation company and to ADC. Order replacement equipment, if necessary.
- Check the packing list to ensure complete and accurate shipment of each listed item. If the shipment is short or irregular, contact ADC as described in [“Appendix D - Product Support”](#) on page 68. If you must store the equipment for a prolonged period, store the equipment in its original container.



# TABLE OF CONTENTS

<b>Overview</b> .....	<b>1</b>
Features .....	1
Compatibility .....	2
Applications .....	2
<b>Front Panel</b> .....	<b>3</b>
<b>Installation</b> .....	<b>7</b>
Verification .....	8
Verification without an H2TU-R Remote Unit .....	8
Verification with an H2TU-R Remote Unit .....	8
<b>Provisioning</b> .....	<b>9</b>
Reviewing System Settings.....	9
Accessing the Provisioning Screens .....	9
Connecting to a Maintenance Terminal.....	9
Logon Screen .....	10
Provisioning Tasks .....	12
Setting Date and Time .....	12
Setting Circuit ID Numbers .....	13
Configuring the System .....	14
Resetting to Factory Defaults .....	24
Clearing the History, Alarm, and Event Log Screens .....	25
<b>Monitoring System Activity and Performance</b> .....	<b>26</b>
Performance Monitoring From the H2TU-R .....	26
Payload Retrieval of Margin and Loop Attenuation Parameters .....	27
Using the Monitor Screen to View System Activity.....	28
Using the Performance Screens to View Performance Data.....	30
Performance History at the DS1 Interface.....	30
Blockage Indicator Statistics at the H2TU-R DS1 Interface .....	34
Performance History at the HDSL2 Interface .....	35
Blockage Indicator Statistics at the H2TU-R HDSL2 Interface.....	38
Using the Performance Screens to View Alarm Data.....	39
Alarm History at the DS1 Interface .....	39
Alarm History at the HDSL2 Interface.....	41
Using the System Event Log to Track Events .....	42
Origin Tags .....	43
Event Log Messages .....	44
Using the Sectionalized Event Log to Isolate Trouble .....	45

Using the Report Menu .....	47
<b>Testing</b> .....	<b>49</b>
System Alarms.....	49
Alarm Option for Digital Loop Carrier Feed .....	50
Retiring System Alarms .....	50
Remote LOS and AIS Response .....	51
OCT55 Test Pattern with AMI Code.....	51
Loopback Operation .....	52
Generic Loopback Commands .....	53
Special Loopback Commands .....	54
Manual Loopback Session.....	55
Setting the Loopback Time-Out Option.....	55
Activating Manual Loopback Mode .....	55
Loopback Test Procedures .....	56
General Troubleshooting Tips .....	56
GNLB Test Procedures .....	56
A1LB, A2LB, and A5LB Test Procedures .....	58
A3LB and A4LB Test Procedures .....	60
Testing with the H2TU-R Signal Generator.....	61
<b>Appendix A - Specifications</b> .....	<b>62</b>
Power Consumption .....	63
Maximum Power Dissipation .....	63
Maximum Current Drain .....	63
Loop Attenuation and Insertion Loss .....	64
H2TU-C-202 Card-Edge Connector.....	64
Network Management Control Bus .....	65
Fuse Alarm .....	65
System Alarm Output Pins.....	65
Craft Port .....	65
<b>Appendix B - Functional Operation</b> .....	<b>66</b>
Timing .....	66
Ground Fault Detect .....	66
<b>Appendix C - Compatibility</b> .....	<b>67</b>
Compatible Shelves and Enclosures.....	67
<b>Appendix D - Product Support</b> .....	<b>68</b>
<b>Appendix E - Abbreviations</b> .....	<b>69</b>
<b>Certification and Warranty</b> .....	<b>Inside Back Cover</b>

## LIST OF FIGURES

1. H2TU-C-202 List 2F Front Panel.....	3
2. Installing the H2TU-C-202 Into a Shelf.....	7
3. Logon Screen.....	11
4. Config Menu - Date and Time.....	12
5. Inventory Screen.....	13
6. Config Menu.....	14
7. Config Menu - Standard Options (defaults shown).....	15
8. Config Menu - ADC Options (defaults shown) .....	15
9. Config Menu - Set Factory Defaults .....	24
10. Config Menu - Master Clear.....	25
11. Sectionalized Analysis of the DS1 Interface .....	26
12. Monitor Screen - Active Loopback with Alarms .....	28
13. H2TU-R DS1 31-Day Performance History .....	31
14. H2TU-C DS1 48-Hour Performance History.....	31
15. H2TU-R DS1 25-Hour Performance History.....	32
16. H2TU-R DS1 Current Statistics .....	32
17. H2TU-C DS1 Current Statistics .....	33
18. H2TU-R DS1 Blockage Indicator History Screen (DS1 Interface) .....	34
19. H2TU-C HDSL2 31-Day Performance History .....	35
20. H2TU-C HDSL2 48-Hour Performance History .....	35
21. H2TU-C HDSL2 25-Hour Performance History .....	36
22. H2TU-C HDSL2 Current Statistics.....	36
23. H2TU-R Blockage Indicator History Screen (HDSL2 Interface).....	38
24. H2TU-C DS1 Alarm History Screen.....	39
25. H2TU-R DS1 Alarm History Screen.....	40
26. H2TU-C HDSL2 Alarm History Screen .....	41
27. System Event Log Screen.....	42
28. Sectionalized Event Log Screen.....	45
29. Sectionalized Events.....	46
30. Report Menu - Full Report.....	47
31. H2TU-R LOS and AIS Response Priorities .....	51
32. Loopback Summary.....	52
33. Loopback Modes .....	57
34. H2TU-R Signal Generator Screen.....	61
35. H2TU-C-202 List 2F Card-Edge Connector .....	64
36. RS-232 Craft Port Pinouts.....	65
37. H2TU-C-202 List 2F Block Diagram.....	66

# LIST OF TABLES

1. Front-Panel Description .....	4
2. Front-Panel Display Messages.....	5
3. Navigational Keys for the Maintenance Terminal Screens .....	10
4. Logon Screen Menus .....	11
5. H2TU-C-202 Standard Config Menu Options.....	16
6. H2TU-C-202 ADC Config Menu Options .....	17
7. DS1/DSX-1 24-Hour PM Threshold .....	20
8. Response to H2TU-R DS1 Frame Conversion Options .....	22
9. Extended SuperFrame Format .....	22
10. SuperFrame Format .....	23
11. Bit Error Indication of Margin and Loop Attenuation Parameters .....	28
12. Monitor Screen Descriptions .....	29
13. Error Acronyms Used on the DS1 Performance History Screens .....	33
14. Error Acronyms Used on the HDSL2 Performance History Screens .....	37
15. DS1 Alarm Descriptions.....	40
16. HDSL2 Alarm Descriptions.....	41
17. Origin Tags .....	43
18. Event Log Messages .....	44
19. Sectionalized Event Definitions.....	46
20. Report Types.....	48
21. Front-Panel System Alarms Summary .....	49
22. Summary of HiGain HDSL2 Loopback Codes and Activation Methods.....	53
23. Addressable Repeater Loopback Commands (A1LB, A2LB, A5LB).....	58
24. Addressable Repeater Loopback Commands (A3LB and A4LB).....	60
25. Signal Generator Option Settings .....	61
26. H2TU-C Power Parameters .....	63
27. HDSL2 Reach Chart .....	64



# OVERVIEW

The H2TU-C-202 List 2F line unit is the Central Office (CO) side of a T1 transmission system. The HiGain™ HDSL2 product family is fully compliant with the HDSL2 standard ANSI T1.418-2000. Providing full rate T1 access using just a single copper pair, HDSL2 is a cost-effective solution that offers an open architecture. The open architecture inherent in HDSL2 guarantees interoperability allowing simple and economic accommodation of network growth.

HiGain HDSL2 products provide 1.544 Mbps transmission on one unconditioned copper pair over the full Carrier Service Area (CSA) range. The CSA includes loops up to 12,000 feet of 24 AWG wire or 9,000 feet of 26 AWG wire, including bridged taps.

## FEATURES

Enhanced features include:

- Report menu option for downloading status and performance monitoring data to a file
- Dual front-panel loopback commands
- Additional Loopback Timeout (LBTO) settings of 8 hours and 24 hours
- 16-bit inband retrieval of margin and loop attenuation

Standard features include:

- HDSL2 transmission features
  - Lightning and power cross-protection on HDSL2 interfaces
  - Full-duplex HDSL2 transmission on one pair at 1.552 Mbps
  - Ultra-low wander (for Stratum 1 transport)
  - Grounded loop detection on High-bit-rate Digital Subscriber Line 2 (HDSL2)
- Front-panel features
  - Four-character status display
  - DS1 bridging access
  - Status Light Emitting Diode (LED)
  - RS-232 craft port for connection to a maintenance terminal
- Maintenance screens for inventory, provisioning, and troubleshooting
  - Non-volatile DS1 and HDSL2 performance monitoring and alarm histories
  - Performance Report Messaging (PRM) support for Supplemental PRM (SPRM) and Network PRM (NPRM) at the H2TU-R
  - Payload (PL) and HiGain (HG) loopback source identification
  - Margin Alarm (MAL) threshold
  - Remote provisioning through TL1 FDL or 11-bit payload commands
- Configuration options
  - Selectable DSX-1 pre-equalizer
  - Bipolar Violation Transparency (BPVT) option
  - Bit Error Rate (BER) alarm

- Power Back Off Network (PBON) and Power Back Off Customer (PBOC) options for configuring HDSL2 transmit power levels
- Loss of Signal/Alarm Indication Signal (LOS/AIS) payload alarm
- Selectable loopback activation codes
- Network Management and Administration (NMA) interface



**DS1 is used throughout this document to refer to either the remote unit's DS1 interface or the line unit's DSX-1 interface.**

## COMPATIBILITY

The H2TU-C-202 List 2F is designed to mount in 200 and 400 mechanics, high-density shelves. For a list of compatible shelves, see [“Appendix C - Compatibility” on page 67](#).

## APPLICATIONS

HiGain HDSL2 systems provide a cost-effective, easy-to-deploy method for delivering T1 High Capacity Digital Service (HCDS) over a single copper pair. HiGain HDSL2 systems support a multitude of network connections and system models.

- The service is deployed over one unconditioned, non-loaded copper pair.
- Conventional inline DS1 repeaters are no longer required.
- Cable pair conditioning, pair separation, and bridged tap removal are not required.

Each loop should have no more than 35 dB of insertion loss at 196 kHz, with driving and terminating impedances of 135 $\Omega$ . In general, HiGain HDSL2 systems:

- Operate effectively in the same cable binder group with other HDSL2 lines, HDSL, DS1, ADSL, SDSL, POTS, Digital Data Service (DDS), and other transmission schemes.
- Can be used with customers requiring DS1 service on a temporary or permanent basis.
- Provide a means of quickly deploying service in advance of fiber-optic transmission systems.

# FRONT PANEL

Figure 1 shows the H2TU-C-202 List 2F front panel. Table 1 on page 4 describes the front-panel components. For pinout diagram of the H2TU-C card-edge connector, see Figure 35 on page 64. For a pinout diagram of the craft port, see Figure 36 on page 65.

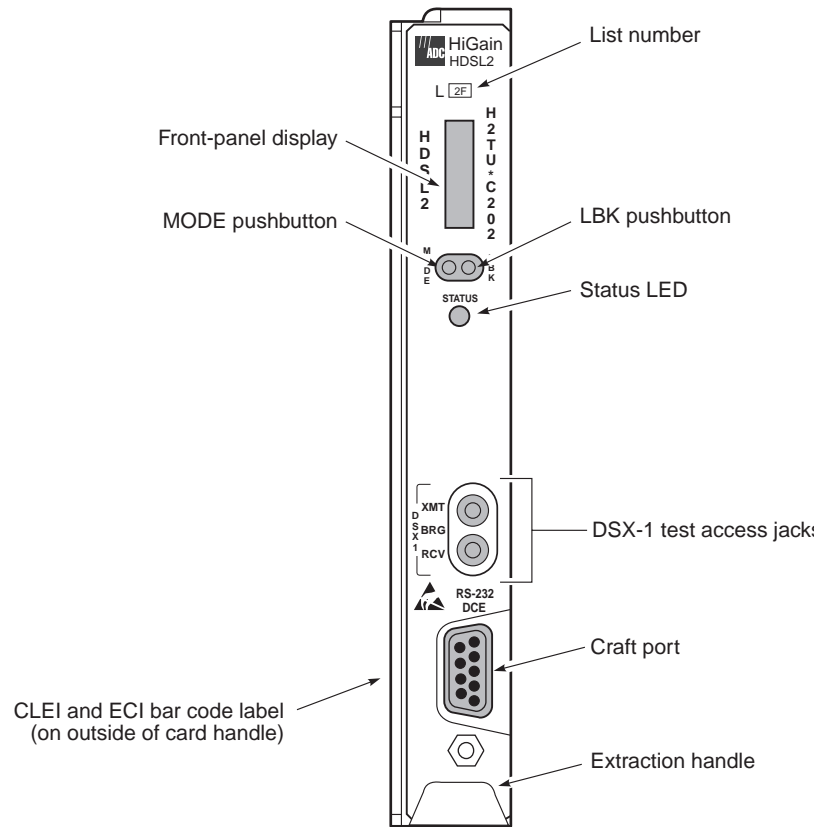

**Figure 1.** H2TU-C-202 List 2F Front Panel

**Table 1. Front-Panel Description**

<b>Front-Panel Feature</b>	<b>Function</b>
List number	Identifies the list number of the H2TU-C.
Front-panel display	Displays four-character status, provisioning, and alarm system messages. The front-panel display illuminates when power is initially applied. To conserve power, the display only remains on for 5 minutes. Using the MODE or LBK pushbuttons reactivates the display and restarts the 5-minute timer. Refer to <a href="#">Table 2 on page 5</a> for a listing of the four-character messages.
MODE and LBK pushbuttons	Permits user options, system parameters, and line unit identity to be reviewed without the need for a maintenance terminal. A maintenance terminal is required to access provisioning screens and make configuration changes. The MODE and LBK pushbuttons can initiate all loopbacks. (See <a href="#">“Manual Loopback Session” on page 55</a> ).
Status LED	The status LED can report the following conditions:
Off	Line power is off.
Green	Normal operation.
Red	Fuse alarm.
Flashing red	HDSL2 acquisition or system alarm.
Yellow	An H2TU-C Customer Remote Loopback (CREM) or a Network Local Loopback (NLOC) is in effect.
Flashing yellow	H2TU-C is in an Armed (ARM) state.
DSX-1 access jacks (BRG)	Provides non-intrusive bridging jack access to (XMT) and from (RCV) the HDSL2 span at the DSX-1 interface. Allows the two DS1 payloads to be monitored.
Craft port (RS-232)	Provides bidirectional communication between the unit and an external terminal to allow configuration and performance monitoring through the maintenance terminal screens.
CLEI and ECI bar code label	Provides the human-readable Common Language Equipment Identifier (CLEI) code number and the Equipment Catalog Item (ECI) bar code number.
Extraction handle	Handle used to remove the H2TU-C from the enclosure.

Table 2 lists the front-panel display messages. The four-character display reports the code of an alarm, loopback, or diagnostic message and, in some cases, is followed by a four-character message that modifies the first message with a value or current configuration setting.

**Table 2. Front-Panel Display Messages**

Message	Full Name	Description
<b>SYSTEM ALARM MESSAGES</b>		
ACO	Alarm Cutoff	A system alarm has occurred and has been retired to an ACO condition by pressing the LBK pushbutton on the H2TU-C front panel.
ALRM	Alarm Condition Exists	A system alarm condition is in effect.
DBER	DS1 Bit Error Rate	A system DS1 BER alarm is in effect and remains in effect until cleared.
HBER	HDSL2 Block Error Rate	A system HDSL2 Block Error Rate alarm is in effect.
LA	Loop Attenuation	Indicates that the attenuation on the HDSL2 loop has exceeded the maximum threshold value.
LAIS	Line Alarm Indication Signal	Indicates an AIS (unframed all ones) pattern is being received or transmitted at the H2TU-C DS1 input or output ports.
LLOS	Line (Unit) Loss of Signal	Indicates that no signal is detected at the DSX-1 input to the H2TU-C. Causes a system alarm.
LOSW	Loss of Sync Word	Indicates that the HDSL2 loop has lost synchronization.
MAL	Margin Alarm	The margin on HDSL2 loop has dropped below the threshold (0 to 15 dB) as set by the operator.
PWR FEED GND	Power Feed Ground	The HDSL2 loop is grounded.
PWR FEED OPEN	Power Feed Open	Indicates a line power open condition.
PWR FEED SHRT	Power Feed Short	Indicates a short between the Tip and Ring of the HDSL2 pair.
PRMF	Performance Report Messaging - Far End	H2TU-R PRM-FE BER threshold has been exceeded.
PRMN	Performance Report Messaging - Near End	H2TU-R PRM-NE BER threshold has been exceeded.
RAIS	Remote Alarm Indication Signal	Indicates an AIS (unframed all ones) pattern is being received or transmitted at the H2TU-R DS1 input or output ports.
RLOS	Remote (Unit) Loss of Signal	Indicates that no signal is detected at the DS1 input to the H2TU-R. Causes a system alarm.
RRAI	Remote RAI—Remote Alarm Indication at the H2TU-R (Net signal has errors.)	Indicates an RAI alarm (yellow) from the CPE with errors from the line unit or network.
TRCI	Transmit RAI-CI—Remote Alarm Indication at the H2TU-R (Net signal does not have errors.)	Upon reception of an RAI alarm (yellow) from the CPE, the H2TU-R sends RAI-CI towards the network if the network signal received at the H2TU-R is clear. If the network signal is impaired (LOS, AIS or Loss of Frame [LOF]), then the RAI is passed on to the network unaltered.
TUC	Transmission Unit Central Office	Accompanies the DBER, HBER, MAL, and LA alarm and indicates that the alarm has occurred at the H2TU-C central office unit.
TUR	Transmission Unit Remote End	Accompanies the DBER, HBER, MAL, and LA alarm and indicates that the alarm has occurred at the H2TU-R remote unit.
<b>LOOPBACK MESSAGES</b>		
CLOC	Customer Local Loopback	DS1 signal from customer is looped back to the customer at the H2TU-R.
COLB	Central Office Loopback	Dual loopback at the H2TU-C.
CREM	Customer Remote Loopback	DS1 signal from customer is looped back to the customer at the H2TU-C.
NLOC	Network Local Loopback	DSX-1 signal is looped back to the network at the H2TU-C.
NREM	Network Remote Loopback	DSX-1 signal is looped back to the network at the H2TU-R.
RULB	Remote Unit Loopback	Dual loopback at the H2TU-R.
SMJK	Remote SmartJack Loopback	DSX-1 signal is looped back to the network at the H2TU-R SmartJack module.

*Continued*

**Table 2.** Front-Panel Display Messages (Continued)

Message	Full Name	Description
<b>DIAGNOSTIC MESSAGES</b>		
A = xx	Maximum Loop Attenuation	The Attenuation (A) message appears followed by xx, where xx is the highest loop attenuation measured in dB.
ACQ	Acquisition	The multiplexers of the H2TU-C and H2TU-R are trying to establish synchronization over the HDSL2 loop.
ARM	HiGain System Armed	Armed to respond to Intelligent Repeater Loop (ILR) codes.
BAD RT?	No Response from H2TU-R	The H2TU-C does not receive any response from the H2TU-R and all HDSL2 loop conditions are normal. Therefore, the integrity of the H2TU-R or the HDSL2 loop is questionable.
FERR	Framing Bit Error Occurred	Framing bit error occurred at H2TU-C DSX-1 input.
HES	HDSL2 CRC Error	H2TU-C HDSL2 Loop Cyclical Redundancy Check (CRC) error.
LBPV	Local Bipolar Violation	A bipolar violation has been received at the DSX-1 input to the H2TU-C.
M=xx	HDSL2 Loop Margin	Indicates the power of the received HDSL2 signal relative to noise (S/N with respect to 21.5 dB). Any value of 6 dB or greater is adequate for reliable system operation.
MNGD	Managed	The H2TU-C is under control of the H2TU-319 network management unit. In this state, the front-panel craft port and pushbuttons are disabled.
PWR FEED OFF	Power Feed Off	HDSL2 span power has been turned off by setting the PWRF option to off, or HDSL2 span power has been turned off by use of the A1LB, A2LB, or A5LB Intelligent Office Repeater (IOR) Power Down code.
PWR FEED ON	Power Feed On	Indicates that the HDSL2 loop is not grounded or shorted.
SIG	Signaling	The transceivers of the H2TU-C and H2TU-R are trying to establish contact with each other over the HDSL2 loop.
<b>SYSTEM INFORMATION MESSAGES <sup>(a)</sup></b>		
CODE xxxx	Line Code: AMI or B8ZS	The line code that H2TU-C is receiving at its DSX-1 interface, if the DS1 option is set to AUTO. Otherwise, it mimics either of the other two DS1 line codes, Alternate Mark Inversion (AMI) or Bipolar with 8-Zero Substitution (B8ZS).
FRM xxxx	Frame: SF, ESF, UNFR	Defines the type of frame pattern being received from the DSX-1: SuperFrame (SF), Extended SuperFrame (ESF), or Unframed (UNFR).
LATT xx	Loop Attenuation	Current loop attenuation threshold setting is measured in dB.
LIST xx	List Number	List number of the H2TU-C-202.
MARG xx	Margin	Current margin threshold setting is measured in dB.
VER x.xx	Software Version Number	Software version number of the H2TU-C-202.

(a) System information messages are displayed in Scroll mode. To scroll through the messages, press the MODE pushbutton for 3 or more seconds.

# INSTALLATION



Upon receipt of the equipment, visually inspect the contents for signs of damage. If the equipment has been damaged in transit, immediately report the extent of damage to the transportation company and to ADC.

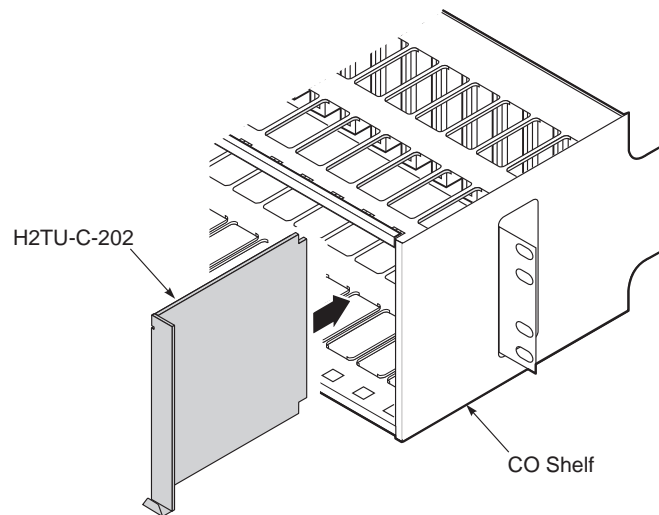

*Figure 2. Installing the H2TU-C-202 Into a Shelf*



When installing an H2TU-C-202 List 2F in a chassis, be sure to wear an antistatic wrist strap. Avoid touching components on the circuit board.



To comply with the intrabuilding wiring requirements of GR-1089 CORE, Section 4.5.9, the shields of the ABAM-type cables that connect the H2TU-C-202 DSX-1 output ports to the cross-connect panel must be grounded at both ends.

- 1 Align the H2TU-C with the enclosure slot guides and slide the unit in until it touches the backplane card-edge connector.
- 2 Place your thumbs on the front panel and push the H2TU-C into the card guides until properly seated.

## VERIFICATION

Once the H2TU-C-202 List 2F is installed, verify that it is operating properly. To do this, monitor the following:

- Status LED
- Status messages reported by the front-panel display. [Table 2 on page 5](#) describes the messages.



**For information regarding turnup instruction, see the Help menu and select Turn-up Aid.**

### Verification without an H2TU-R Remote Unit

If there is no H2TU-R remote unit installed:

- 1 Verify that the H2TU-C powers up. The front-panel display illuminates and reports status messages. (See [Table 2 on page 5](#) for a list of messages.)
- 2 Verify that the H2TU-C attempts to communicate with a remote unit (status LED flashes red). Even if a remote unit is not present, the following events should occur:
  - The front-panel display reports various four-character status messages.
  - The H2TU-C again attempts communication until a remote unit is detected.

### Verification with an H2TU-R Remote Unit

If an H2TU-R remote unit has been installed:

- 1 Verify that the H2TU-C powers up. (The front-panel display illuminates and reports various status messages.)
- 2 Verify that the H2TU-C attempts to communicate with the remote unit (status LED flashes red). One of the following occurs:
  - If the remote unit is successfully identified and the HDSL2 loop synchronizes, the H2TU-C status LED lights a steady green. The H2TU-C reports normal margin messages on the front-panel display.
  - If the remote unit is not identified, the H2TU-C reports four-character status messages. The H2TU-C attempts communication again and reports four-character status messages. The H2TU-C repeats this cycle until a remote unit is detected.
- 3 Verify that a valid DS1 signal has been applied to the H2TU-C and the H2TU-R.
  - If no DS1 signal is being applied to either the H2TU-C or the H2TU-R inputs, then the appropriate DS1 alarms (LLOS or RLOS) display on the front panel and the status LED flashes red.
  - If a valid DS1 signal is being supplied to the H2TU-C and H2TU-R, then DS1 alarm indications should be absent and the status LED should be a steady green.



# PROVISIONING

To provision the H2TU-C, access the provisioning screens through a maintenance terminal.

## REVIEWING SYSTEM SETTINGS

To scroll through the current settings of all system parameters, press the MODE pushbutton for 3 or more seconds. The H2TU-C-202 displays the following parameters:

- Software version number
- List number
- Type of frame pattern received from the DSX-1
- Line code of the signal received from the DSX-1
- All user-configured parameter settings
- Loop attenuation threshold setting
- Margin alarm threshold setting

## ACCESSING THE PROVISIONING SCREENS

### Connecting to a Maintenance Terminal

The craft port on the front panel allows you to connect the H2TU-C to a maintenance terminal, such as an ASCII terminal or PC running a terminal emulation program. Once connected to a maintenance terminal, you can access the maintenance, provisioning, and performance screens.



To connect to a maintenance terminal:

- 1 Connect a standard 9-pin terminal cable to the RS-232 craft port, as shown in [Figure 1 on page 3](#), on the H2TU-C front panel.
- 2 Connect the other end of the cable to the serial port on the maintenance terminal.
- 3 Start a terminal emulation program such as Procomm (emulating a VT100 terminal).
- 4 Configure the maintenance terminal to the following communication settings:
  - 9600 baud
  - No parity
  - 8 data bits
  - 1 stop bit
  - Hardware flow control to OFF
- 5 If necessary, press **CTRL** + **R** to refresh the logon screen.

## Logon Screen





The maintenance terminal screens allow you to monitor, provision, and troubleshoot an HDSL2 system.

To select a menu from the logon screen shown in [Figure 3 on page 11](#), do one of the following:

- Press the underlined letter of the menu.
- Use the   arrow keys to select the menu, then press **ENTER**.

[Table 3](#) below summarizes the navigational keys. They are also listed in the onscreen Help menu. [Table 4 on page 11](#) describes the logon screen menus.

**Table 3.** *Navigational Keys for the Maintenance Terminal Screens*

Key <sup>(a)</sup>	Function
<b>SPACEBAR</b>	Cycle through selections.
<b>ENTER</b>	Activate the current setting or choice, or display a menu.
<b>ESC</b> or <b>F11</b> (VT100 only)	Return to the parent menu.
 or <b>CTRL + E</b>	Select the submenu or item above the current one, or return to the previous menu.
 or <b>CTRL + X</b>	Select the submenu or item below the current one.
 or <b>CTRL + D</b>	Select the menu or item to the right of the current one.
 or <b>CTRL + S</b>	Select the menu or item to the left of the current one, or return to the previous menu.
<b>CTRL + R</b>	Refresh the screen.

(a) Legacy management units require use of control keys instead of arrow keys.



**Most VT100 emulation programs support a print screen option. For Windows-based programs, such as Procomm or HyperTerminal, see the Help menu for instructions.**

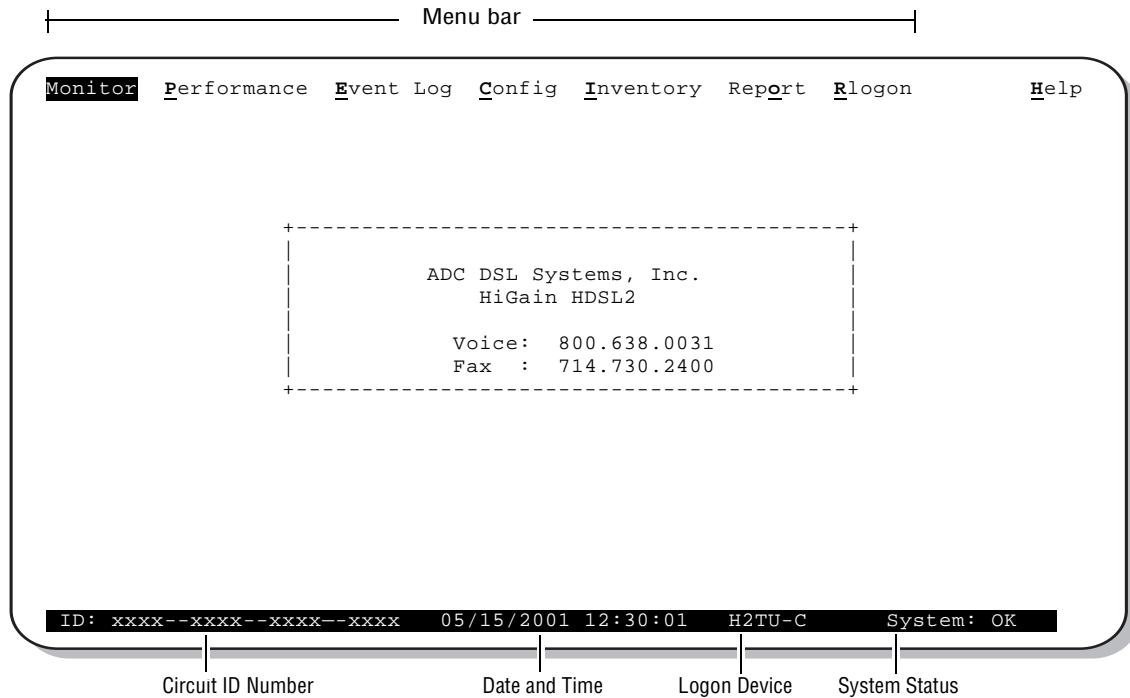

**Figure 3.** Logon Screen

**Table 4.** Logon Screen Menus

Press this key:	To access this menu:	Menu Functions
<b>M</b>	Monitor	Monitors loopbacks and alarms, provides a graphical representation of circuit activity, including ES, UAS, SES, and line code.
<b>P</b>	Performance	Provides performance and alarm histories for current, 25-hour, 48-hour, or 31-day periods for either the DS1 or HDSL2 interface. Selecting this menu after a remote logon will permit viewing of the H2TU-R Blockage Indicator (BI) History screen, as displayed from the DS1 interface. See <a href="#">Figure 11 on page 26</a> and <a href="#">Figure 18 on page 34</a> .
<b>E</b>	Event Log	Identifies the 100 most recent system events and reports the date and time of occurrence. Selecting this menu after a remote logon displays the Sectionalized Event Log for the H2TU-R. See <a href="#">Figure 28 on page 45</a> .
<b>C</b>	Config	Provides standard configuration options, ADC options, date and time setting, and a reset option (factory settings). Also provides a master clear option that clears all performance, alarm, and event log entries.
<b>I</b>	Inventory	Provides product information about the various devices that are in the system and lists circuit and device identifications.
<b>O</b>	Report	Provides four types of reports: Full Report, Short Report, System Information Report, and Event Report.
<b>R</b>	Rlogon/Rlogout	Remote logon can be performed from the H2TU-C or H2TU-R. The screen displays Rlogout when the H2TU-C or H2TU-R is remotely logged on to the other unit at the end of the circuit.  Remote logon from the H2TU-C will permit viewing of the H2TU-R Blockage Indicator History screen and Sectionalized Event Log screen,  To log off from the remote unit, press <b>R</b> . Rlogout changes to Rlogon. The unit is now locally logged on until <b>R</b> is pressed again to re-initiate the remote logon.
<b>H</b>	Help	Provides a glossary of terms used in the maintenance screens, a list of navigational keys, aids for turn-up and printing, and ADC contact information.

## PROVISIONING TASKS

After the H2TU-C-202 is successfully installed, perform these basic provisioning tasks:

- Set date and time (see “Setting Date and Time” below).
- Set circuit ID numbers (see “Setting Circuit ID Numbers” on page 13).
- Make any configuration changes (see “Configuring the System” on page 14).
- Clear history, alarm, and event log screens to remove miscellaneous data during startup (see “Clearing the History, Alarm, and Event Log Screens” on page 25).

### Setting Date and Time

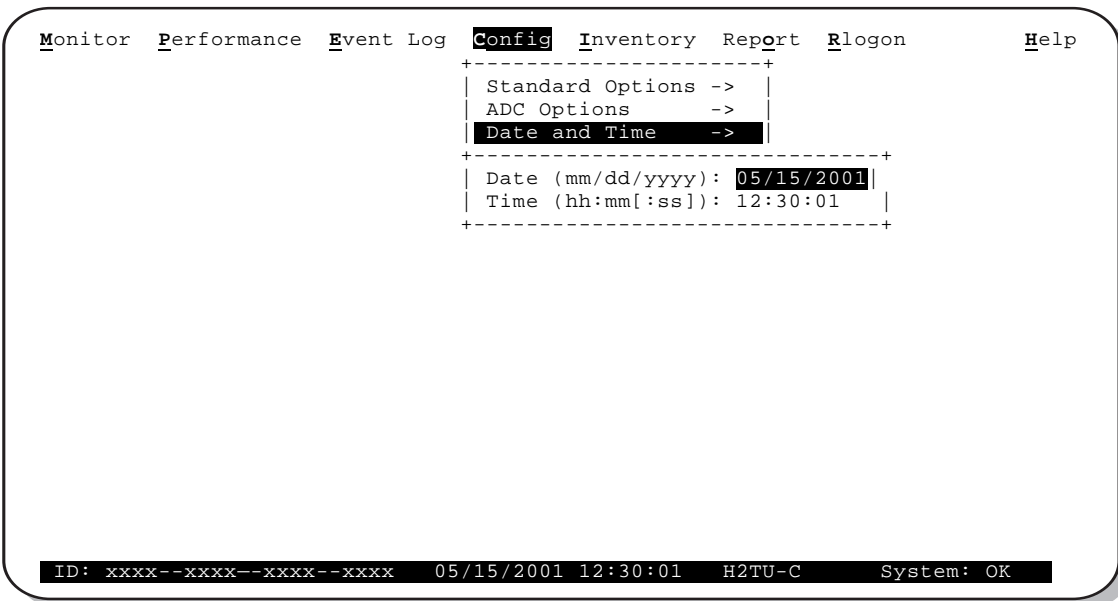

*Figure 4. Config Menu - Date and Time*

- 1 Press **C** to select the Config menu.
- 2 Use the **↑** and **↓** arrow keys to select **Date and Time**, then press **ENTER**.
- 3 Type the date in the format indicated, then press **ENTER**.
- 4 Type the time in the format indicated (entering seconds is optional), then press **ENTER**.

## Setting Circuit ID Numbers

The Inventory screen provides product information on all units in the system and allows setting of the circuit and unit identification numbers.

```

Monitor Performance Event Log Config Inventory Report Rlogon Help
-----
Product Information -----
Unit      : H2TU-C          H2TU-R
Product   : H2TU-C-202     H2TU-R-402
List      : 2F             4F
Sw Ver.   : 3.00           3.00
Build #   : 08             08
Checksum  : 0xCF91         0xCF91
H2 Xcvr   : L1-HB2 1.51    L1-HB2 1.51
Serial #  : 01232456789    0123456789
CLEI     : VACHZW8GAA      VARHWUUGAA
Mfg. Date: 01/05/01       01/05/01
-----
Circuit and Unit Identifications -----
Circuit ID  : xxxx--xxxx--xxxx--xxxx
H2TU-R ID   : yyyy--yyyy--yyyy--yyyy
Circuit Notes:

ID: xxxx--xxxx--xxxx--xxxx 05/15/2001 12:30:01 H2TU-C System: OK

```

**Figure 5.** Inventory Screen

- 1 Press **I** to select the Inventory screen.
- 2 Type the Circuit ID number, then press **ENTER**.
- 3 Type the ID numbers of all other devices listed in the system, pressing **ENTER** after each entry.

## Configuring the System

The Config menu, shown in [Figure 6](#), allows you to make the following types of system configuration changes:

- Standard options ([Figure 7](#) on page 15)
- ADC options ([Figure 8](#) on page 15)
- Date and time (see “[Setting Date and Time](#)” on page 12)
- Master clear (see “[Clearing the History, Alarm, and Event Log Screens](#)” on page 25)
- Reset to factory default configuration, described in “[Resetting to Factory Defaults](#)” on page 24

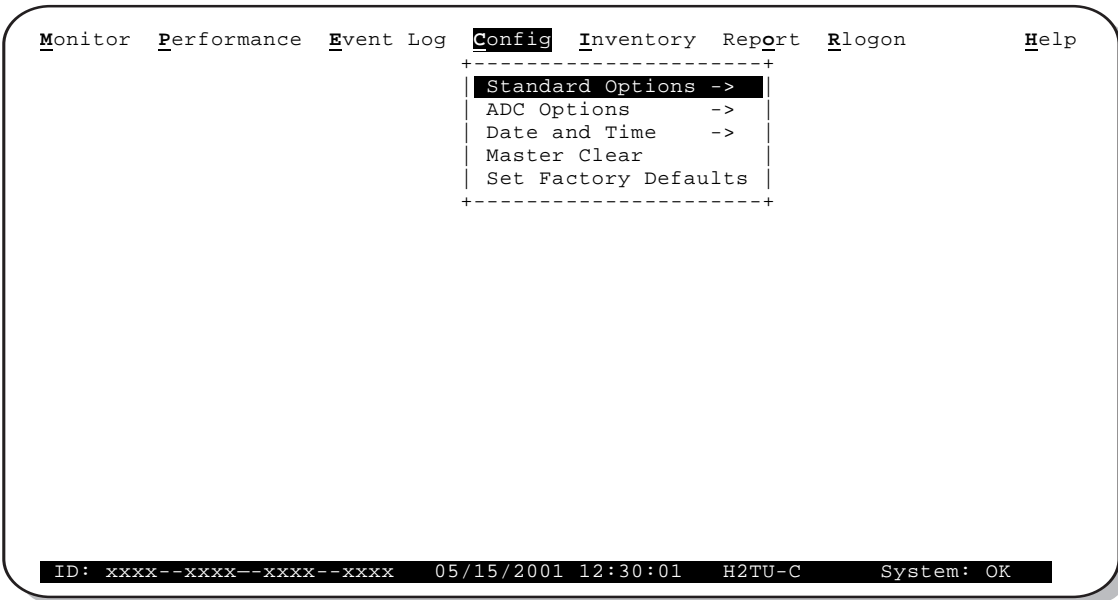

*Figure 6. Config Menu*



Most of the H2TU-C-202 configuration options can also be set from a network test center through TL1 commands embedded in the ESF FDL (non-intrusive) or in the payload itself with 11-bit commands (intrusive).

To obtain additional information about remote provisioning commands, contact customer service. See “[Appendix D - Product Support](#)” on page 68.

### Making Changes to Standard and ADC Options

[Figure 7](#) and [Figure 8](#) on page 15 show the Standard and ADC configuration options. Standard options are those that are supported by HiGain HDSL2 units when connected to units from other vendors. ADC options are an extended set of options available only when using HiGain units exclusively. For a description of each option and a list of option settings, refer to [Table 5](#) on page 16 and [Table 6](#) on page 17.

To make changes to these options:

- 1 Press **C** to select the Config menu.
- 2 Use the **↑** and **↓** arrow keys to select **Standard Options** or **ADC Options**, then press **ENTER**.
- 3 Use the arrow keys to select an option.
- 4 Press the **SPACEBAR** to cycle through the settings for that option.
- 5 Press **ENTER** to activate your choice.

```

Monitor  Performance  Event Log  Config  Inventory  Report  Rlogon      Help
+-----+
| Standard Options -> |
+-----+
| Loopback Timeout (LBTO)                : 60 min |
| Loop Attenuation Threshold (LATT) [0-40]: 38 dB |
| Margin Threshold (MARG) [0-15]: 4 dB |
| DS1 Frame Formatting (FRMG)             : UNFR |
| DS1 Line coding (DS1)                   : B8ZS |
| H2TU-C Equalization (EQL)               : 0 |
| H2TU-R Line Buildout (RLBO)             : 0 dB |
| Alarm Pattern (ALMP)                    : AIS |
| H2TU-R TLOS Loopback (TLOS)             : DIS |
| Network Loopback Pattern (NLBP)         : AIS |
| Power Back Off Customer (PBOC)         : DEF |
| Power Back Off Network (PBON)          : DEF |
+-----+

Use <Spacebar> to cycle through option settings and <Enter> to activate
ID: xxxx--xxxx--xxxx--xxxx 05/15/2001 12:30:01 H2TU-C System: OK

```

Figure 7. Config Menu - Standard Options (defaults shown)

```

Monitor  Performance  Event Log  Config  Inventory  Report  Rlogon      Help
+-----+
| Standard Options -> |
| ADC Options -> |
+-----+
| Line Power Feed (PWRF)                  : ON |
| Bipolar Violation Transparency (BPVT)   : DIS |
| DS1 BER (DBER)                          : DIS |
| HDSL2 BER Threshold (HBER)              : NONE |
| Special Loopback Mode (SPLB)           : GNLB |
| SmartJack Loopback (LPBK)              : ENA |
| Minor Alarm (ALM)                       : DIS |
| Remote Disconnect Alarm (RDA)           : ENA |
| Network AIS Signal (NAIS)               : AIS |
| Performance Report Messaging (PRM)      : AUTO |
| RAI to RAI-CI toward NET (RACI)        : DIS |
| ESF-RAI to SF-RAI Overwrite (ROVR)     : DIS |
| H2TU-R DS1 Frame Conversion (CONV)     : ACON |
+-----+

Use <Spacebar> to cycle through option settings and <Enter> to activate
ID: xxxx--xxxx--xxxx--xxxx 05/15/2001 12:30:01 H2TU-C System: OK

```

Figure 8. Config Menu - ADC Options (defaults shown)

Table 5 below describes the Standard Config menu options and Table 6 on page 17 describes the ADC Config menu options. Bold type indicates the factory default settings.

**Table 5. H2TU-C-202 Standard Config Menu Options**

Standard Config Menu Options	Front-Panel Display Code	Selection	Description
Loopback Timeout	LBTO	NONE	Disables automatic time-out cancellation of all loopbacks.
		20 min	Sets automatic cancellation of all loopbacks to 20 minutes after initiation.
		<b>60 min</b>	Sets automatic cancellation of all loopbacks to 60 minutes after initiation.
		120 min	Sets automatic cancellation of all loopbacks to 120 minutes after initiation.
		8 hr	Sets automatic cancellation of all loopbacks to 8 hours after initiation.
		24 hr	Sets automatic cancellation of all loopbacks to 24 hours after initiation.
Loop Attenuation Threshold	LATT	0 through 40 dB	Determines the maximum loop attenuation before an alarm is declared. Zero disables the alarm. The loop attenuation threshold can only be set through the maintenance screens.
		<b>38 dB</b>	Default value.
Margin Threshold	MARG	0 to 15 dB	Determines the minimum allowable margin below which a system alarm can occur. Zero disables the alarm. The Margin (Alarm) Threshold can only be set through the maintenance screens.
		<b>4 dB</b>	Default value.
DS1 Frame Formatting	FRMG	AUTO	Configures the HiGain HDSL2 system to operate in an auto-framing (AUTO) mode in which it continuously searches the input DS1 bit stream for a valid SF or ESF frame pattern. Both line and path performance parameters are maintained. Unframed payloads will cause the ES-P and SES-P counters to increment.
		<b>UNFR</b>	Configures the HiGain HDSL2 system to operate in an unframed mode. This mode disables the auto framing process and forces the system to function as a transparent bit pipe. Only line parameters are considered when monitoring DS1 performance.
DS1 Line Coding See "DS1 Line Coding (DS1) Option" on page 19.	DS1	<b>B8ZS</b>	Places both the H2TU-C and H2TU-R into their B8ZS modes.
		AMI	Places both the H2TU-C and H2TU-R into their AMI modes.
H2TU-C Equalization See "H2TU-C Equalization (EQL) Option." on page 19.	EQL	<b>0</b>	Sets the Equalizer to DSX-1 for 0 to 132 feet.
		133	Sets the Equalizer to DSX-1 for 133 to 265 feet.
		266	Sets the Equalizer to DSX-1 for 266 to 398 feet.
		399	Sets the Equalizer to DSX-1 for 399 to 532 feet.
		533	Sets the Equalizer to DSX-1 for 533 to 655 feet.
H2TU-R Line Buildout	RLBO	<b>0 dB</b>	Sets the DS1 RLBO level toward the CI to 0 dB.
		-7.5 dB	Sets the DS1 RLBO receive level toward the CI to -7.5 dB.
		-15.0 dB	Sets the DS1 RLBO receive level toward the CI to -15.0 dB.
			Sets the DS1 receive level output toward the Customer Interface (CI). H2TU-R Line Buildout can only be set through the maintenance screens.
Alarm Pattern See "Alarm Pattern (ALMP) Option" on page 19.	ALMP	<b>AIS</b>	Enables the HiGain HDSL2 system to output an AIS payload at its DS1 ports for LOSW and DS1 LOS. For priority resolution, see Figure 31 on page 51.
		LOS	Enables the HiGain HDSL2 system to output an LOS condition at its DS1 ports for LOSW and DS1 LOS.

*Continued*



**Table 5.** H2TU-C-202 Standard Config Menu Options (Continued)

Standard Config Menu Options	Front-Panel Display Code	Selection	Description
H2TU-R TLOS Loopback	TLOS	ENA	Enables a logic loopback at the H2TU-R when an LOS occurs at its DS1 input, if enabled at the H2TU-R. For priority resolution, see <a href="#">Figure 31 on page 51</a> .
		DIS	Disables Transmit Loss of Signal (TLOS) logic loopback.
Network Loopback Pattern	NLBP	AIS	Enables the H2TU-R to transmit an AIS toward CI for any network loopback. For priority resolution, see <a href="#">Figure 31 on page 51</a> .
		LOS	Enables the H2TU-R to transmit an LOS toward CI for any network loopback.
Power Back Off - Customer See “Power Back Off (PBON and PBOC) Options” on page 19.	PBOC	DEF	Configures the power output levels of the H2TU-R customer unit toward the network to comply with the Default template as defined in Section 6.1.4.2 of ANSI T1/E1.4.
		ENH	Configures the power output levels of the H2TU-R customer unit toward the network to comply with the Enhanced template as defined in Section 6.1.4.2 of ANSI T1/E1.4.
Power Back Off - Network See “Power Back Off (PBON and PBOC) Options” on page 19.	PBON	DEF	Configures the power output levels of the H2TU-C network unit toward the customer to comply with the Default template as defined in Section 6.1.4.2 of ANSI T1/E1.4.
		ENH	Configures the power output levels of the H2TU-C network unit toward the customer to comply with the Enhanced template as defined in Section 6.1.4.2 of ANSI T1/E1.4.

**Table 6.** H2TU-C-202 ADC Config Menu Options

ADC Config Menu Options	Front-Panel Display Code	Selection	Description
Line Power Feed	PWRF	OFF	Disables powering to the HDSL2 pair.
		ON	Keeps the HDSL2 line voltage at nominal -180 Vdc.
Bipolar Violation Transparency See “Bipolar Violation Transparency (BPVT) Option” on page 19.	BPVT	ENA	Enables HDSL2 CRC and BPV errors at the DS1 input to be converted into DS1 BPVs at the DS1 output at the distant end. This makes HiGain HDSL2 transparent to BPVs.
		DIS	Disables BPV Transparency.
DS1 BER Threshold See “DS1 BER (DBER) Option” on page 20.	DBER	ENA	Enables the fixed 24-hour DS1 BER threshold ( $10^{-6}$ ).
		DIS	Prevents the generation of a system alarm due to DS1 BER.
HDSL2 BER Threshold See “HDSL2 BER (HBER) Threshold Option” on page 20.	HBER	1E-6	Front-panel alarm is displayed and the Status LED flashes red when the Block Error Rate (BER) threshold exceeds $10^{-6}$ . BER is based on the definition of Bit Error Rate.
		1E-7	Front-panel alarm is displayed and the Status LED flashes red when the Block Error Rate (BER) threshold exceeds $10^{-7}$ .
		NONE	Prevents generation of a system alarm due to BER.

*Continued*

**Table 6.** H2TU-C-202 ADC Config Menu Options (Continued)

ADC Config Menu Options	Front-Panel Display Code	Selection	Description
Special Loopback Mode	SPLB	<b>GNLB</b>	Configures the HiGain HDSL2 system to respond to the generic inband loopback codes.
		A1LB and A2LB	Configures the HiGain HDSL2 system to respond to the inband loopback codes of the Westell addressable repeater.
		A3LB	Configures the HiGain HDSL2 system to respond to the inband loopback codes of the Wescom addressable repeater.
		A4LB	Configures the HiGain HDSL2 system to respond to the inband loopback codes of the Wescom Mod 1 addressable repeater.
		A5LB	Configures the HiGain system to respond to the inband loopback codes of the Westell Mod 1 addressable repeater.
SmartJack Loopback	LPBK	<b>ENA</b>	Enables the HiGain HDSL2 system to recognize all inband SmartJack (SMJK) loopback commands.
		<b>DIS</b>	Configures the HiGain HDSL2 system to ignore all inband SmartJack loopback commands.
Minor Alarm	ALM	<b>ENA</b>	Enables the generation of the output alarm on pins 30 and 22 when a system alarm condition occurs.
		<b>DIS</b>	Disables the generation of the output alarm on pins 30 and 22 when a system alarm condition occurs.
Remote Disconnect Alarm	RDA	<b>ENA</b>	Enables a remote DS1 LOS condition at the input to the H2TU-R to generate an LOS alarm. AIS or LOS (depending on ALMP) is sent toward the network.
		<b>DIS</b>	Prevents a remote DS1 LOS condition at the input to the H2TU-R from causing an LOS alarm. The alarm relay contacts do not close and LOS is sent toward the network from the H2TU-C instead of AIS.
Network AIS Signal	NAIS	<b>CI</b>	If ALMP is set to AIS, this option specifies which pattern is sent to the network when a remote LOS or AIS occurs. When configured for CI, an AIS-CI pattern is sent to the network. For priority resolution, see <a href="#">Figure 31 on page 51</a> .
		<b>AIS</b>	When configured for AIS, an AIS pattern is sent to the network.
Performance Report Messaging	PRM	<b>SPRM</b>	The H2TU-R generates SPRM if no PRM is present from the CPE. If the CPE is sending PRM, the PRM is converted to an SPRM. TL1 commands and responses are enabled.
		<b>NPRM</b>	The H2TU-R generates Network PRM (NPRM) if no PRM is present from the CPE. If the CPE is sending PRMs, NPRM is generated in addition to the existing PRM every second. TL1 commands and responses are enabled.
		<b>AUTO</b>	The H2TU-R generates both SRPMs and NPRMs whenever possible.
		<b>OFF</b>	ESF Datalink (DL) is completely transparent. No PRMs are generated. There are no TL1 responses unless the system is first armed by a TL1 command, which enables Performance Monitoring (PM).
RAI to RAI-CI Toward NET See "RAI to RAI-CI toward NET (RACI)" on page 20.	RACI	<b>ENA</b>	Allows a DS1 RAI (yellow alarm) signal received by the H2TU-R to be converted to an RAI-CI signal towards the network.
		<b>DIS</b>	Prevents conversion of the DS1 RAI to an RAI-CI signal.
ESF-RAI to SF-RAI Overwrite See "ESF-RAI to SF-RAI Overwrite (ROVR) Option" on page 21.	ROVR	<b>ENA</b>	If the CONV option is set to FCON or ACON, an ESF DS1 payload from the network with an embedded RAI pattern is converted to an SF-RAI pattern toward the CI at the H2TU-R.
		<b>DIS</b>	Prevents conversion to an SF-RAI pattern.

*Continued*

**Table 6.** H2TU-C-202 ADC Config Menu Options (Continued)

ADC Config Menu Options	Front-Panel Display Code	Selection	Description
H2TU-R DS1 Frame Conversion	CONV	OFF	Framing functionally determined by the framing option. Frame format conversion is inhibited at the H2TU-R.
See "H2TU-R DS1 Frame Conversion (CONV) Option" on page 21.		<b>ACON</b>	Auto (ACON) detection of framing and potential frame conversion at the remote.
		FCON	Auto detection of framing and forced frame format conversion (FCON) at the H2TU-R.

**DS1 Line Coding (DS1) Option.** The DS1 line code option should always be set to conform to the type of DS1 service (AMI or B8ZS) being provided by the HiGain system.

**H2TU-C Equalization (EQL) Option.** The equalizer shapes the DS1 output signal of the H2TU-C to conform to a very specific pulse template when it arrives at the DSX-1 cross-connect point. The degree of pulse-shaping required is a function of the distance between the H2TU-C's equipment bay and the DSX-1 panel. Thus, the equalizer has six discrete settings, in increments of 133 feet to cause the maximized separation of 655 feet.

**Alarm Pattern (ALMP) Option.** To improve HiGain HDSL2 compatibility with the switch-to-protect features used in Digital Loop Carrier (DLC) feeder applications, the H2TU-C-202 List 2F has an ALMP option that allows you to select either an AIS or LOS DS1 output payload for the following alarms:

- LOSW on any loop
- LOS DS1

**Power Back Off (PBON and PBOC) Options.** Power Back Off Network (PBON) and Power Back Off Customer (PBOC) allow the HDSL2 circuit to support two transmit power templates: default (DEF), higher level, and enhanced (ENH), lower level. These are defined in Section 6.1.4.2 of the ANSI T1E1.4 HDSL2 standard. Each HDSL2 receiver detects the level it is receiving during the start-up, pre-activation sequence. It then compares this level to the level it should be receiving according to the PBON and PBOC option settings (DEF or ENH). If the received level is outside the template limits, the receiver sends a message to the upstream HDSL2 transmitter requesting the proper level. These levels are adjusted only during the start-up routine or if the PBON or PBOC option settings are changed during normal operation. Since the ENH template levels are up to 15 dBm below those of the DEF template, the ENH setting can be used to reduce crosstalk levels into adjacent circuits. (For example, if crosstalk noise is being induced by the H2TU-R, set the PBOC option to its lower (ENH) level setting. Conversely, if the HDSL2 signal at the H2TU-R is being affected by crosstalk noise induced from adjacent pairs, set the PBOC option to its higher (DEF) level setting.



**Changing these Power Back Off option settings on a live circuit causes the HDSL2 loop to momentarily drop and then reacquire synchronization. This setting can also affect the operating margins.**

**Bipolar Violation Transparency (BPVT) Option.** The H2TU-C-202 List 2F improves compatibility with the DLC feeder applications because of its ability to transmit DS1 BPV occurrences between its DS1 interfaces. This feature is required to support protection switching in DLC applications. Each DLC terminal must be able to monitor the integrity of its Receive DS1 payload and then switch to the protect line when the integrity of the path drops below specific user selected limits.

An essential requirement is for each DLC terminal to detect BPVs in its DS1 input. Standard HDSL systems correct DS1 BPVs at the input and, therefore, prevent them from being detected by the DLC terminals to which they are connected. The H2TU-C-202 List 2F and its associated remote units remove this limitation and become

BPV transparent by detecting and counting input BPVs at each end and then by replicating them at the DS1 output port of the distant end.

The BPV count is converted into BPVs at the distant end during the following second at a rate of 1 BPV every 128 DS1 bits up to a maximum of 12000 ( $BER=7.7 \times 10^{-3}$ ). This maximum rate is more than adequate since it exceeds the maximum  $10^{-3}$  BER required by most DLC systems.

**DS1 BER (DBER) Option.** The DS1 BER alarm occurs when any of the DS1 or DSX-1 performance monitoring parameters listed in Table 7 exceed the counts shown for the 24-hour period between 12:00:00 AM through 11:59:59 PM. These thresholds correspond to a  $10^{-6}$  BER. All PM counters clear to zero at 12:00:00 AM or when Master Clear is selected.

*Table 7. DS1/DSX-1 24-Hour PM Threshold*

Parameter	Threshold Count
CV-L (BPV)	133,400
CV-P (CRC)	132,960
ES-L, ES-P, PRM-NE PRM-FE	648
SES-L, SES-P	100
UAS-P, UAS-L	10

**HDSL2 BER (HBER) Threshold Option.** The HBER option permits the monitoring of loop integrity and reporting of alarms when excessive errors are detected. The PM primitive used for this purpose is the CRC checksum performed on the HDSL2 frame for both directions of transmission. It is, therefore, called a block error rate rather than the bit error rate associated with the DS1 interface. The CRC errors and counts are displayed on the Monitor screen for both the H2TU-C and H2TU-R. The HBER option allows an alarm to be generated if the total number of CRCs at either the H2TU-C or H2TU-R exceeds the selected BER threshold during the last 1-minute interval.

- HBER option = 1E-6. Alarm is generated if CRC > 93.
- HBER option = 1E-7. Alarm is generated if CRC > 9.

Once initiated, the HBER count clears when the CRC count drops below the selected threshold. Selecting NONE inhibits this alarm.

**RAI to RAI-CI toward NET (RACI).** The H2TU-C-202 in conjunction with the H2TU-R-402 List 4F supports the RAI-CI function.

The RAI-CI signal is a RAI signal which contains a signature indicating that an LOF or AIS failure has occurred in the customer installation (CI) at the H2TU-R unit and that the defect or failure which caused the origination of that RAI is not found in the signal from the network. Therefore, RAI-CI is transmitted toward the network when the following two conditions are simultaneously true at the point from which RAI-CI originated (at the H2TU-R, toward the network):

- RAI is received from the CI.
- No LOF, LOS, or AIS failure is detected in the signal received from the network.

Sending RAI-CI terminates within 500  $\mu$ s when either of the following occurs:

- Cessation of RAI from the CI.
- Declaration of LOF, LOS, or AIS in the signal from the network.

To prevent the transmission of RAI-CI during the failure-clearing interval of a network failure, the transition from RAI to RAI-CI is delayed for 20 seconds following the detection of conditions 1 and 2 above. Since RAI-CI meets

the definition of RAI, it may be detected and used exactly as RAI. The longer period of time required for detection of RAI-CI does not affect its use for functions which require RAI.

The RAI-CI pattern is a function of the payload frame format as follows:

- **ESF**—The RAI-CI signal is a repetitive pattern in the Frame Bit for Datalink (FDL) with a period of 1.08 seconds. RAI-CI is formed by sequentially interleaving 0.99 (+/- 2 ms) seconds of the normal message 00000000 11111111 (right-to-left) with 90 milliseconds (+/- 2 ms) of the message 00111110 11111111 (right-to-left) to flag the signal as RAI-CI.
- **SF**—The SF-RAI-CI signal is transmitted inband by setting each of the 24 channel time lots to 1000 1011 (left-to-right). In addition to the criteria specified above, the generation of SF-RAI-CI has to be held off for 1 second to examine the DS0s for a framed, all-zeros pattern. If present, the generation of SF-RAI-CI is suspended for the duration of the all-zeros pattern.



**Since the RAI to RAI-CI conversion modifies the payload for SF applications, an RACI option is available to inhibit the RAI to RAI-CI conversion for those SF applications that cannot tolerate payload modifications.**

**ESF-RAI to SF-RAI Overwrite (ROVR) Option.** If the ESF-RAI to SF-RAI Overwrite (ROVR) option is enabled, it allows a network ESF-RAI or ESF-RAI-CI pattern to be converted into a CPE SF-RAI or SF-RAI-CI pattern.

If the ROVR option is disabled, it prevents conversion of a network ESF payload with an embedded RAI pattern. Disabling the ROVR option preserves the integrity of the CPE payload as it was originally transmitted.

**H2TU-R DS1 Frame Conversion (CONV) Option.** Frame format conversion is only applicable to the remote H2TU-R, but selectable by the H2TU-C or H2TU-R. This option enables the network to be ESF which is used to embed SPRM or NPRM into the datalink toward the network. During conversion, frame bit errors are regenerated to ensure transparency.

The HDSL2 system attempts to find ESF or SF framing or determines that no framing exists. The DS1 framing is then synchronized with the HDSL2 frame. If the framing is lost, the system generates an Out-of-Frame (OOF) defect which results in UAS-P. As a result, the system reverts to frame search mode.

This option has the following settings:

- **OFF** — No frame conversion takes place. All framing issues are determined by the FRMG option settings of AUTO and UNFR.
- **ACON** — This is the automatic conversion setting. If the system detects ESF from the network and SF from the CPE, it automatically converts the CPE SF to ESF toward the network as well as the network ESF to SF toward the CPE.

Upon power-on-reset, after loopdown, or after changing the frame conversion option, the framing needs to be re-established before a complete conversion takes place. If there is a failure condition (LOS, AIS, or LOF) during steady state, the previous conversion state is maintained to ensure continuity when the system returns from the failure condition.

If SF is received from the network, the H2TU-R forces an ESF toward the network for about 1.5 seconds. This signals to the far end PM-NIU at the network boundary that frame conversion is requested. If the far end PM-NIU is capable of conversion, it changes the framing to ESF. If not, then the H2TU-R reverts to SF and does not apply any conversion.

If an ESF is received from the CPE, it is passed on to the network, and the network's inbound framing is passed on to the CPE.

- **FCON** — This is the forced conversion setting. [Table 8 on page 22](#) lists the HiGain HDSL2 responses by case number to both the ACON and FCON settings for the CONV option. The responses are identical, except in cases 3 and 4. In these cases, the FCON reply is attempting to force the network or the far end PM-NIU to

send ESF. It also alerts the CPE with an AIS alarm pattern while forcing the ESF to the network. Continuity is maintained as for ACON. Table 9 on page 22 and Table 10 on page 23 list the ESF and SF frame formats, respectively.

**Table 8.** Response to H2TU-R DS1 Frame Conversion Options

Case Number	NET Transmit	CPE Transmit	ACON Option	FCON Option
			NET > CPE NET < CPE	NET > CPE NET < CPE
1	ESF	SF	ESF →SF ESF ←SF	ESF →SF ESF ←SF
2	ESF	ESF	ESF →ESF ESF ←ESF	ESF →ESF ESF ←ESF
3	SF	ESF	SF →SF ESF ←ESF	SF →AIS ESF ←ESF
4	SF	SF	SF →SF SF ←SF	SF →AIS ESF ←SF

**Table 9.** Extended SuperFrame Format

ESF Number	Frame Bits		
	Framing Pattern Sequence (FPS) - 2 kb/s	Frame Bit for Datalink (FDL) - 4 kb/s	Cyclical Redundancy Check (CRC) Bits - 2 kb/s
1		m	
2			C1
3		m	
4	0		
5		m	
6			C2
7		m	
8	0		
9		m	
10			C3
11		m	
12	1		
13		m	
14			C4
15		m	
16	0		
17		m	
18			C5
19		m	
20	1		
21		m	
22			C6
23		m	
24	1		

**Table 10.** SuperFrame Format

SF Number	Frame Bits	
	Terminal Framing Bit	SuperFrame Signaling Bit
1	1	
2		0
3	0	
4		0
5	1	
6		1
7	0	
8		1
9	1	
10		1
11	0	
12		0

**AIS-CI (Alarm Indication Signal-Customer Installation).** The H2TU-C-202 in conjunction with the H2TU-R-402 List 4F supports the AIS-CI function. AIS-CI is a variant of AIS which is transmitted toward the network when either an AIS defect or an LOS defect has been detected in the signal received from the CI at the H2TU-R unit. AIS-CI is a regular AIS signal modulated by an AIS signature.

The AIS-CI signal is a repetitive pattern with a period of 1.26 seconds. The pattern is formed by sequentially interleaving 1.11 seconds of an unframed all ones pattern and 0.15 seconds of all ones modified by the AIS-CI signature. The AIS-CI signature is defined as a pattern which recurs at 386 bit intervals (two DS1 frame lengths in the DS1 signal and is 01111100 11111111 (right to left). This results in a repetitive pattern of 6176 bits. If the first bit is numbered bit 0, bits 3088, 3474, and 5790 are logical zeroes and all other bits in the pattern are logical ones.

An alternative interpretation of the AIS-CI signature is that the AIS signal modified by the AIS-CI signature is equivalent to an ESF signal in which the FPS bits, the CRC-6 bits, and the payload are set to all ones and the DL is overwritten by the pattern 01111100 11111111.



**The NAIS option controls the AIS-CI feature. When NAIS is set to CI, the AIS to AIS-CI conversion is enabled. When NAIS is set to AIS, the conversion is inhibited.**

## Resetting to Factory Defaults



Resetting the H2TU-C to its original factory settings may cause interruption of service.

To reset the H2TU-C-202 to its original factory defaults:

- 1 Press **C** to select the Config menu.
- 2 Use the **↑** and **↓** arrow keys to select **Set Factory Defaults**, then press **ENTER**.
- 3 Press **Y** to reset the H2TU-C, or press **N** to cancel this action.

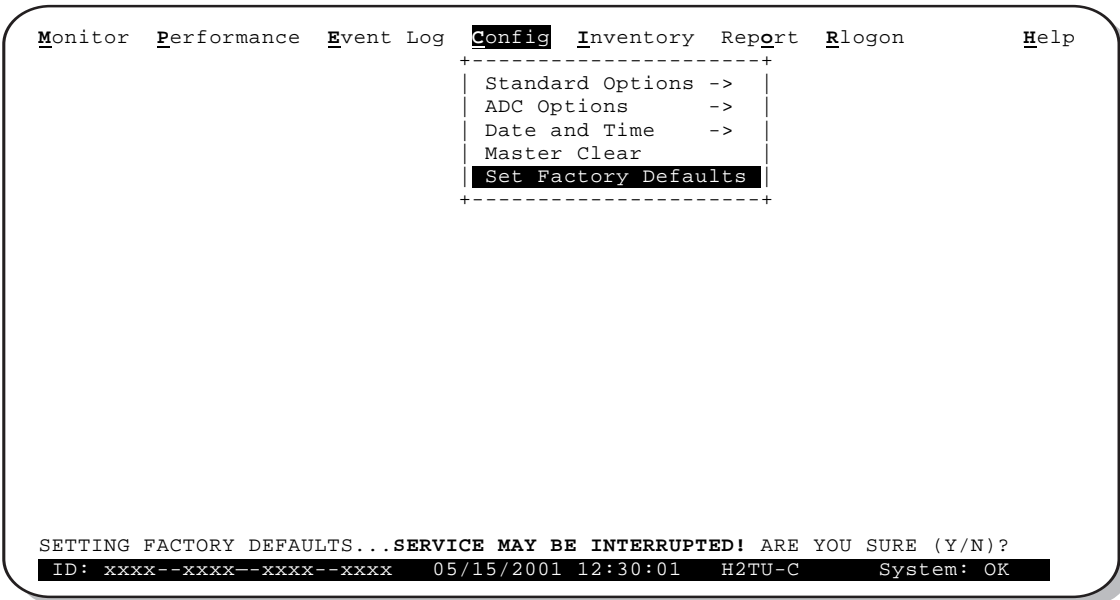

Figure 9. Config Menu - Set Factory Defaults



## Clearing the History, Alarm, and Event Log Screens

Select Master Clear to clear the History, Alarm, and Event Log screens after the system has been installed and is functioning properly. This removes miscellaneous data acquired during the startup session and ensures collection of accurate and meaningful data thereafter.



*Figure 10. Config Menu - Master Clear*

To clear the Event Log, press **E** to select the Event Log screen, then press **L** to clear the screen.

To clear an individual history or alarm screen, do the following:

- 1 Press **P** to select the Performance screen.
- 2 Press the **SPACEBAR** to select an interface (**H2TU-C DS1**, **H2TU-R DS1**, **H2TU-C HDSL2**, or **H2TU-R HDSL2**), then press **ENTER**.
- 3 Press the **SPACEBAR** to select the type of statistics (**Current**, **Alarm History**, **25 Hour History**, **48 Hour History**, or **31 Day History**), and press **ENTER** after your selection.
  - Selecting **31 Day History** allows you to clear the Current, 25-hour, 48-hour, and 31-day performance history screens for the selected interface.
  - Selecting **Alarm History** allows you to clear the alarm history screen for the selected interface. For information about the DS1 and HDSL2 Alarm screens, see [Table 15 on page 40](#) and [Table 16 on page 41](#), respectively.
- 4 Press **L** to clear the screen.

To clear ALL history, alarm, and event log screens by this method:

- 1 Press **C** to select the Config screen.
- 2 Use the **↑** and **↓** arrow keys to select **Master Clear**.
- 3 Press **Y** to clear all screens.

# MONITORING SYSTEM ACTIVITY AND PERFORMANCE

The HDSL2 system provides the following maintenance screens for monitoring system activity and assessing performance.

- The Monitor screens provide a graphical representation of circuit activity and allow initiation of loopbacks.
- The Performance screens provide current, 25-hour, 48-hour, and 31-day performance histories and a continuous alarm history.
- The Event Log provides a description of the 100 most recent events, which include their origin, time and date of occurrence, and message.
- Following a remote logon, the Performance screens provide current and 8-hour Blockage Indicator histories at the H2TU-R DS1 interface.
- Following a remote logon, the Sectionalized Event Log screen displays events for all four legs of the H2TU-R DS1 interface.

## PERFORMANCE MONITORING FROM THE H2TU-R

Network surveillance is a key maintenance strategy. Real-time monitoring of performance through sectionalized analysis allows maintenance personnel to quickly locate a service degradation or failure. This also makes it easier to determine if the customer or network operator must bear responsibility for service and repair.

The Performance Monitoring screens analyze the DS1 transmission by tracking the four transmission legs shown in [Figure 11](#).

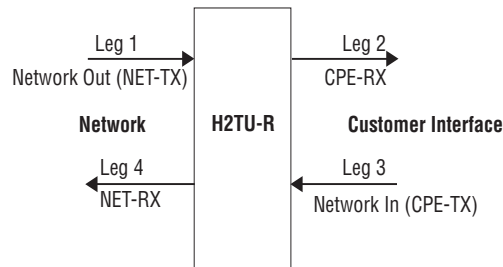

**Figure 11.** Sectionalized Analysis of the DS1 Interface

When installed on one end of an HDSL2 DS1 circuit, the remote unit provides the following special network benefits:

- Real-time performance monitoring of DS1 signals in both directions of transmission
- Non-intrusive access to real-time performance monitoring data (CPE-provided SF or ESF signal)

- Easy access to stored DS1 PM data using the craft port, 11-bit inband commands, or Facility Data Link (FDL):
  - Performance statistics (current, 25-hour, 48-hour, and 31-day)
  - Sectionalized events for all four legs of DS1 transmission
  - Blockage indicator (a quality-of-service summary statistic for the NET-TX and CPE-TX transmission legs at the DS1 interface)
- Easy access to stored HDSL2 PM data
- AIS-CI insertion toward the network upon detection of incoming LOS or AIS at the network interface
- RAI-CI insertion toward the network upon receiving RAI from the CPE, if the signal from the network is not impaired
- Loopback toward the network with AIS insertion to the CPE equipment
- Adaptive frame format conversion if enabled in:
  - SF to ANSI T1.403 ESF
  - Non-standard to standard ANSI T1.403 ESF
  - AT&T PUB 54016 to ANSI T1.403 ESF
- Easy access to remote provisioning:
  - Non-intrusive, using FDL-embedded TL1 commands
  - Intrusive, using 11-bit payload commands

Network Elements (NE), such as the ADA T3AS test and performance monitoring system, can be used to collect the performance monitoring data to allow full-time surveillance of the DS1 signal. By installing T3AS at a network boundary, such as Interexchange Carrier (IEC), Point of Presence (POP), and a remote unit at the network interface), the Local Exchange Carrier (LEC) can monitor the performance of its portion of the network and rapidly sectionalize circuit problems. By sectionalizing problems in its network, the LEC knows, without external involvement, what trouble exists and who is responsible.

## PAYLOAD RETRIEVAL OF MARGIN AND LOOP ATTENUATION PARAMETERS

The List 2F has been enhanced with a new feature that allows an upstream test center to retrieve information on the circuit's margin and loop attenuation. This is accomplished by issuing an intrusive 16-bit inband command DBDB (1101 1011 1101 1011) from the test center towards the line unit. The command is patterned after the 16-bit intelligent repeater loopback commands described in the "Loopback Test Procedures", starting on [page 56](#). The command must be sent for at least 5 seconds. The circuit can be armed, but does not have to be. The line unit must be in the NLOC network loopback state before the retrieval command is issued. After detecting the 16-bit command, the line unit generates and returns a specific number of bit errors indicating a specific combination of margin and loop attenuations as listed in [Table 11 on page 28](#). The error burst occurs every 20 seconds for as long as the DBDB command is being received. The error burst response always reflects the most recent performance parameters. If the HDSL2 loop is down, LOSW, a response corresponding to a margin of 5 or less and loop attenuation of 0 to 25, will be sent. This command is a permanent feature of the List 2F and cannot be disabled.

**Table 11. Bit Error Indication of Margin and Loop Attenuation Parameters<sup>(a)</sup>**

Margin (dB)	Loop Attenuation (dB)	Bit Errors Sent
5 or less	31 or higher	101
5 or less	26 - 30	102
5 or less	0 - 25	103
6 - 10	31 or higher	104
6 - 10	26 - 30	105
6 - 10	0 - 25	106
11 or higher	31 or higher	107
11 or higher	26 - 30	108
11 or higher	0 - 25	109

(a) Expected bit error response.

## USING THE MONITOR SCREEN TO VIEW SYSTEM ACTIVITY

- 1 Press **M** to view the system diagram.

Figure 12 shows an armed circuit with an active loopback and alarms. Terms used on the system diagram are defined in the onscreen Help menu glossary. Abnormal situations are highlighted on the diagram. See Table 12 on page 29 for screen field descriptions.

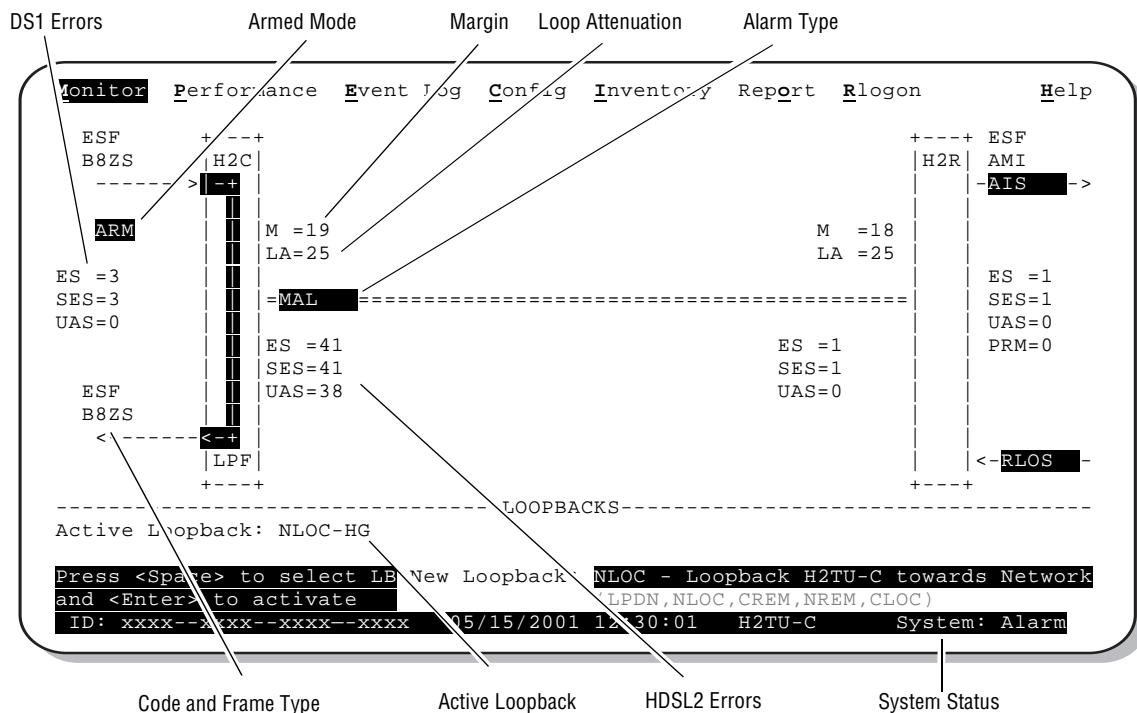

**Figure 12. Monitor Screen - Active Loopback with Alarms**

- 2 To initiate a loopback, press the **SPACEBAR** to cycle through the loopback choices. Press **ENTER** to make your choice.  
When prompted with the message: Are you sure (Y/N)?, press **Y** to initiate the loopback or **N** to cancel. For more information about loopbacks, see “Testing” beginning on page 49.
- 3 To initiate a loopdown, press the **SPACEBAR** to select **LPDN**, then press **ENTER**. When prompted with the message: Are you sure (Y/N)?, press **Y** to initiate the loopdown or **N** to cancel.

**Table 12. Monitor Screen Descriptions**

Field	Description
Active Loopback	An active loopback is indicated on the lower third of the Monitor screen. Available loopbacks are indicated by gray text. <a href="#">Table 22 on page 53</a> provides a summary of the HiGain HDSL2 loopback codes.
Alarm Type	Indicates type of alarm.
Armed Mode	Indicates system is in an armed state for an intelligent repeater (IR) loopback command.
Code Type	Type of DS1 line coding received or sent (B8ZS or AMI).
DS1 ES Count	Errored Seconds—The sum of the Errored Seconds-Line (ES-L) and Errored Seconds-Path (ES-P) counts detected on the DS1 input over a 24-hour period. Errors include DS1 frame errors, BPV, and ESF CRC errors.
DS1 SES Count	Severely Errored Seconds—The sum of the DS1 Severely Errored Seconds-Line (SES-L) and Severely Errored Seconds-Path (SES-P) counts over the last 24 hours.
DS1 UAS Count	Unavailable Errored Seconds—The number of seconds during which the DS1 input signal was absent over a 24-hour period.
Frame type	Type of DS1 framing detected at the input stream (SF, ESF, or UNFR).
HDSL2 ES Count	Errored Seconds—The number of 1-second intervals that contained at least one CRC or LOSW error. This value is a running total of the last 24 Hours.
HDSL2 SES Count	Severely Errored Seconds—The number of 1-second intervals that contain at least 50 CRC errors or one or more LOSW defects. An LOSW defect occurs when at least three consecutive HDSL frames contain one or more frame bit errors. This value is a running total of the last 24 hours.
HDSL2 UAS Count	Unavailable Errored Seconds—The number of seconds the HDSL2 loop is unavailable. This occurs after 10 contiguous HDSL SES and is retired after 10 contiguous non-SES seconds. This value is a running total of the last 24 hours.
HG or (PL)	HG displays when the loopback was initiated from a HiGain (HG) front panel or by a maintenance terminal loopback command. PL displays when the loopback was initiated by a command embedded in the DS1 data path payload (PL).
ID	Circuit identification (ID) number.
LA	Loop Attenuation—Indicates the attenuation of the Overlapped Pulse Amplitude Modulation Transmission with Interlocking Spectra (OPTIS) pulse from the distant end. This value should not exceed 28 dB.
LPF	Line Power Feed—Indicates the HDSL2 line power is on.
M	Margin—The signal-to-noise ratio at all HDSL2 ports, relative to a 10 <sup>-7</sup> Bit Error Rate.
MAL	Margin Alarm—Indicates the margin on HDSL2 loop has dropped below the threshold of 0 to 15 dB as set by the operator.
PRM	The sum of the Performance Report Messaging - Near End (PRM-NE) and Performance Report Messaging - Far End (PRM-FE) counts.
System Status	The presence or absence of an alarm condition is indicated on the lower right corner of all screens. <b>System: OK</b> indicates that there are no alarms present; <b>System: Alarm</b> indicates the presence of an alarm. Refer to “ <a href="#">Using the Performance Screens to View Performance Data</a> ” on page 30 for detailed alarm information.

## USING THE PERFORMANCE SCREENS TO VIEW PERFORMANCE DATA

The Performance screens display:

- DS1 and HDSL2 statistics in 31-day, 48-hour, 25-hour, and current history reports.
- Alarm statistics for DS1 interfaces (Figure 24 on page 39 and Figure 25 on page 40) or the HDSL2 (Figure 26 on page 41) on a continuous basis.

To access the Performance history screens:

- 1 Press **P** to select the Performance screen.
- 2 Press the **SPACEBAR** to select an interface (**H2TU-C DS1**, **H2TU-R DS1**, **H2TU-C HDSL2**, or **H2TU-R HDSL2**), then press **ENTER**.
- 3 Press the **SPACEBAR** to select the type of statistics (**Current**, **Alarm History**, **25 Hour History**, **48 Hour History**, **31 Day History**, or **BI History**), then press **ENTER**.

To view the Blockage Indicator (BI) History screen, you must first log on to the remote unit.

- 1 Press **R** to log on to the H2TU-R remote unit.
- 2 Press **P** to select the Performance screen.
- 3 Press the **SPACEBAR** to select **H2TU-R DS1**, then press **ENTER**.
- 4 Press the **SPACEBAR** to select **BI History**. Press **ENTER**. For more information, see “Blockage Indicator Statistics at the H2TU-R DS1 Interface” on page 34.
- 5 To return to the H2TU-C logon screen, press **R**.

### Performance History at the DS1 Interface

The Performance History for the DS1 Interface provides a 31-day, 48-hour, 25-hour, and current statistics screens for the H2TU-C and H2TU-R (as viewed from the H2TU-C). To gain access to the Blockage Indicator History screen, you must be logged on remotely. See “Using the Performance Screens to View Performance Data” above for logon procedures.

Figure 13 on page 31 and Figure 15 on page 32 are examples of DS1 performance history screens at the remote unit. Figure 14 on page 31 is an example of DS1 performance history screens at the line unit. Refer to Table 13 on page 33 for descriptions of the errors reported on DS1 interface screens. Asterisks indicate performance monitoring from the previous day.

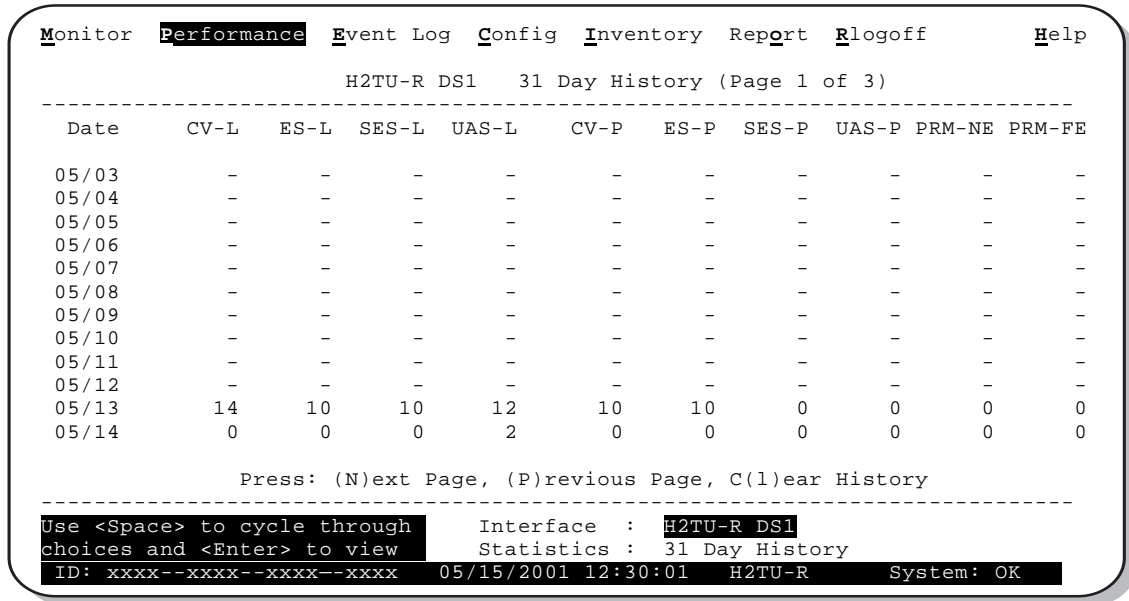

Figure 13. H2TU-R DS1 31-Day Performance History

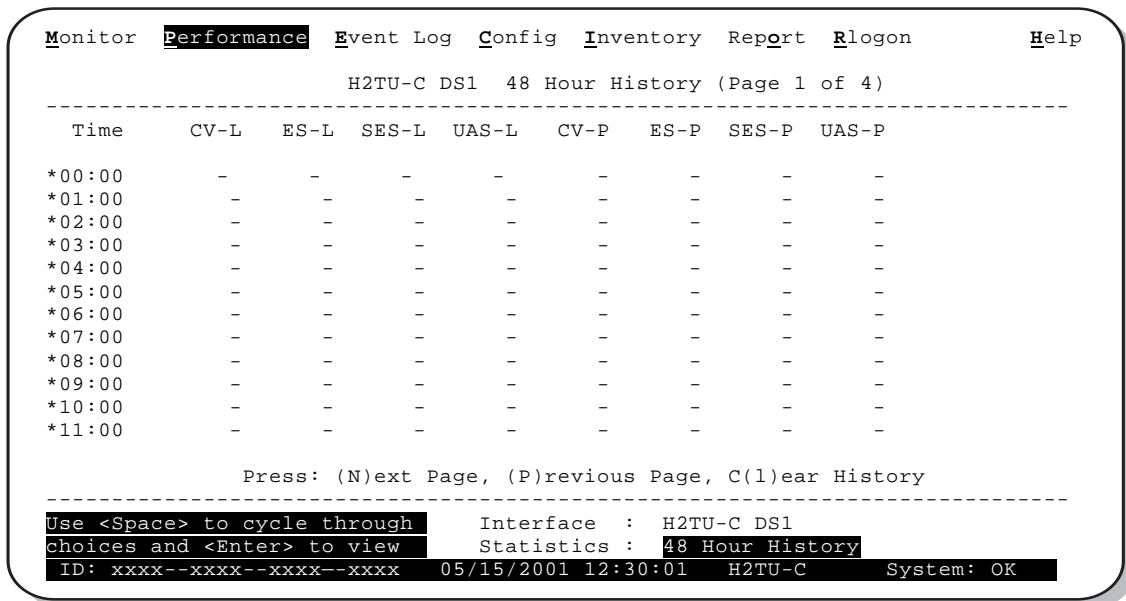

Figure 14. H2TU-C DS1 48-Hour Performance History

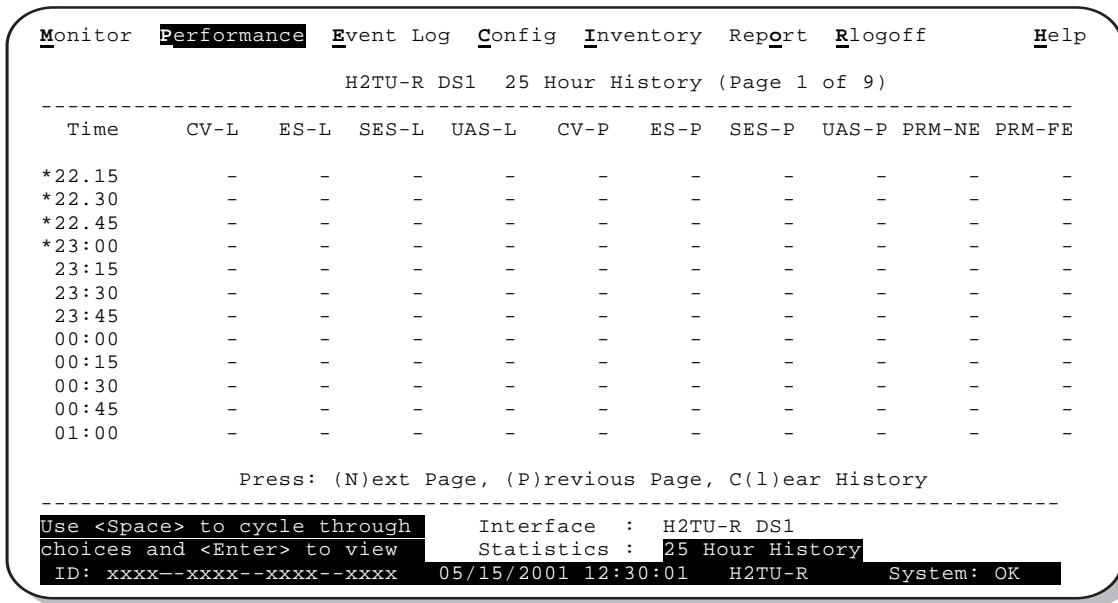

Figure 15. H2TU-R DS1 25-Hour Performance History

Examples of current statistics screens are shown below. Figure 16 and Figure 17 show statistics for the DS1 interface at the remote unit and line unit, respectively. These screens report 1-day, 1-hour, and 15-minute statistics.

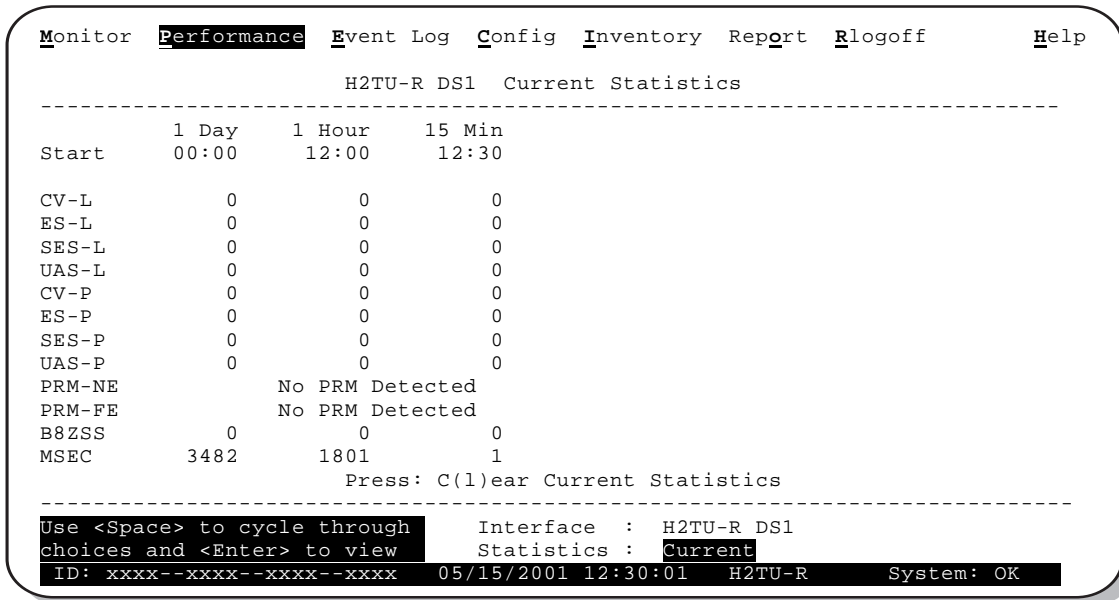

Figure 16. H2TU-R DS1 Current Statistics



```

Monitor Performance Event Log Config Inventory Report Rlogon Help
-----
H2TU-C DS1 Current Statistics
-----
Start      1 Day      1 Hour      15 Min
          00:00      12:00      12:30
CV-L           0           0           0
ES-L           0           0           0
SES-L          0           0           0
UAS-L          0           0           0
CV-P           0           0           0
ES-P           0           0           0
SES-P          0           0           0
UAS-P          0           0           0

B8ZSS          0           0           0
MSEC          3482        1801         1
Press: C(1)ear Current Statistics
-----
Use <Space> to cycle through      Interface : H2TU-C DS1
choices and <Enter> to view      Statistics : Current
ID: xxxx--xxxx--xxxx--xxxx      05/15/2001 12:30:01 H2TU-C System: OK

```

Figure 17. H2TU-C DS1 Current Statistics

Table 13. Error Acronyms Used on the DS1 Performance History Screens

Error Acronym	Description	Error Acronym	Description
CV-L	Code Violation - Line Total BPV count.	UAS-P	Unavailable Seconds - Path A second of unavailability based on SES-P or AIS $\geq 1$ .
ES-L	Errored Seconds - Line Seconds with BPV $\geq 1$ .	PRM-NE <sup>(a)</sup>	Performance Report Monitoring - Near End The PRM registers in the ESF FDL from CPE indicate errors, and the signal received from the network at the remote is error-free.
SES-L	Severely Errored Seconds - Line Seconds with BPV plus EXZ $\geq 1544$ or LOS $\geq 1$ .	PRM-FE <sup>(a)</sup>	Performance Report Monitoring - Far End The PRM registers in the ESF FDL from the network indicate errors, and the signal received from the CPE is error-free.
UAS-L	Unavailable Seconds - Line Seconds with LOS $\geq 1$ .	B8ZSS <sup>(b)</sup>	B8ZS Monitored Seconds Seconds with B8ZS detection when AMI option is active.
CV-P	Code Violation - Path Total count of FE errors for SF or CRC-6 errors for ESF.	MSEC <sup>(b)</sup>	Monitored Seconds of the current (15-minute/1-hour/1-day) screen.
ES-P	Errored Seconds - Path Seconds with SEF <sup>(c)</sup> , CRC (ESF), or FE (SF) $\geq 1$ .	BI <sup>(d)</sup>	Blockage Indicator (BI) = $[(0.2 \times ES + 0.4 \times SES + UAS) / MSEC] \times 100\%$ (MSEC is the same as the DS1 MSEC)
SES-P	Severely Errored Seconds - Path Seconds with SES, CRC (ESF) $\geq 320$ , or FE <sup>(e)</sup> (SF) $\geq 8 (F_T + F_S)$ .		

(a) Only appears on H2TU-R Performance History screens.

(b) Appears on the DS1 Current Statistics screens.

(c) Severely Errored Frame—Two or more frame bit errors occurring in a 0.75 ms interval for SF or a 3 ms interval for ESF.

(d) Only appears on the H2TU-R Blockage Indicator (BI) History screen.

(e) FE is a frame bit error.

## Blockage Indicator Statistics at the H2TU-R DS1 Interface

Figure 18 is an example of an H2TU-R Blockage Indicator (BI) History screen as viewed from the H2TU-C at the DS1 interface following a remote logon. These screens can also be viewed when logged on locally at the remote unit. The BI statistics can also be retrieved using inband or Facility Data Link (FDL) access.

BI is a quality of service (QoS) summary statistic which supplies a quick indicator of circuit performance at the H2TU-R. The BI weighs and averages PM primitives to provide a relative index of performance for leg 1 (NET TX) and leg 3 (CPE TX) of the DS1 interface as shown in Figure 11 on page 26.

BI displays as a percentage for the current hour and for each of the eight preceding hours. After viewing the information, press **R** to return to the H2TU-C logon screen.

```

Monitor Performance Event Log Config Inventory Report Rlogoff Help
                H2TU-R DS1 Blockage Indicator History
-----
Time           NET-TX           CPE-TX
17:00          0%              0%
18:00          0%              0%
19:00          0%              0%
20:00          0%              0%
21:00          0%              0%
22:00          0%              0%
23:00          0%              0%
00:00          0%              0%
01:00          64%             64%

                Press: C(l)ear History
-----
Use <Space> to cycle through      Interface : H2TU-R DS1
Choices and <Enter> to view       Statistics : BI History
ID: xxxx--xxxx--xxxx--xxxx      05/15/2001 01:35:13 H2TU-R System: OK
    
```

Figure 18. H2TU-R DS1 Blockage Indicator History Screen (DS1 Interface)

BI is calculated as follows:

$$BI = [(UAS + .4 SES + .2 ES) / MON] \times 100$$

- where: BI = 0% indicates the circuit leg is clean.
- BI = 99% indicates that the circuit leg is out of service.
- BI = % that is greater than 0% and less than 99%. The higher the BI percentage, the more trouble on that particular circuit leg.
- BI < 99%
- MON = indicates the number of seconds that were monitored in obtaining the UAS, SES, and ES data.
- ES Errored Seconds are a combination of DS1 path and line parameters as defined in ANSI T1.202-1997.
- SES Severely Errored Seconds are based on parameters similar to ES, but are more severe in number.
- UAS Unavailable Seconds or line unavailability is declared at the onset of 10 contiguous SES. For the line, including HDSL loops, to become available, there must be a minimum period of 10 seconds which are free of SES.

## Performance History at the HDSL2 Interface

The HDSL2 interface has 31-day, 48-hour, 25-hour, and current statistic screens for the H2TU-C. Figure 19 and Figure 20 below are examples of 31-day and 48-hour performance history screens. Figure 21 and Figure 22 on page 36 are examples of 25-hour and current statistics performance history screens. Refer to Table 14 on page 37 for descriptions of the kinds of errors reported on all HDSL2 performance screens. Asterisks indicate performance monitoring from the previous day.

```

Monitor  Performance  Event Log  Config  Inventory  Report  Rlogon      Help
-----
                H2TU-C HDSL2 31 Day History (Page 1 of 3)
-----
   Date      CV      ES      SES      UAS      LOSWS
05/03      -      -      -      -      -
05/04      -      -      -      -      -
05/05      -      -      -      -      -
05/06      -      -      -      -      -
05/07      -      -      -      -      -
05/08      -      -      -      -      -
05/09      -      -      -      -      -
05/10      -      -      -      -      -
05/11      -      -      -      -      -
05/12      -      -      -      -      -
05/13      -      -      -      -      -
05/14      14     10     10     14     10

                Press: (N)ext Page, (P)revious Page, C(l)ear History
-----
Use <Space> to cycle through      Interface : H2TU-C HDSL2
choices and <Enter> to view      Statistics : 31 Day History
ID: xxxx--xxxx--xxxx--xxxx      05/15/2001 12:30:01 H2TU-C      System: OK

```

Figure 19. H2TU-C HDSL2 31-Day Performance History

```

Monitor  Performance  Event Log  Config  Inventory  Report  Rlogon      Help
-----
                H2TU-C HDSL2 48 Hour History (Page 1 of 4)
-----
   Time      CV      ES      SES      UAS      LOSWS
*00:00     -      -      -      -      -
*01:00     -      -      -      -      -
*02:00     -      -      -      -      -
*03:00     -      -      -      -      -
*04:00     -      -      -      -      -
*05:00     -      -      -      -      -
*06:00     -      -      -      -      -
*07:00     -      -      -      -      -
*08:00     -      -      -      -      -
*09:00     -      -      -      -      -
*10:00     -      -      -      -      -
*11:00     -      -      -      -      -

                Press: (N)ext Page, (P)revious Page, C(l)ear History
-----
Use <Space> to cycle through      Interface : H2TU-C HDSL2
choices and <Enter> to view      Statistics : 48 Hour History
ID: xxxx--xxxx--xxxx--xxxx      05/15/2001 12:30:01 H2TU-C      System: OK

```

Figure 20. H2TU-C HDSL2 48-Hour Performance History

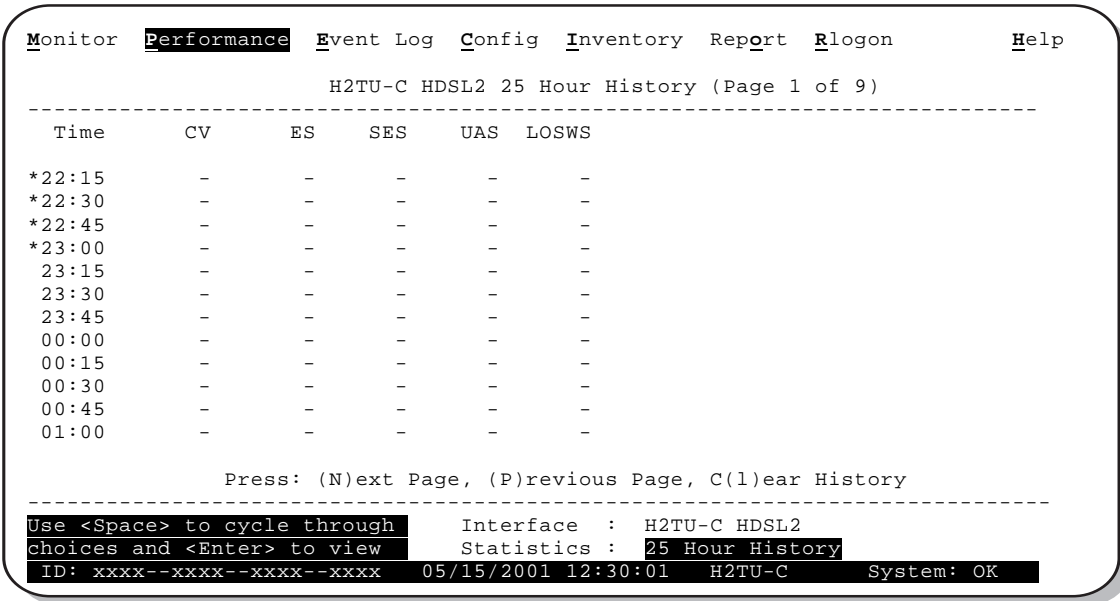

Figure 21. H2TU-C HDSL2 25-Hour Performance History

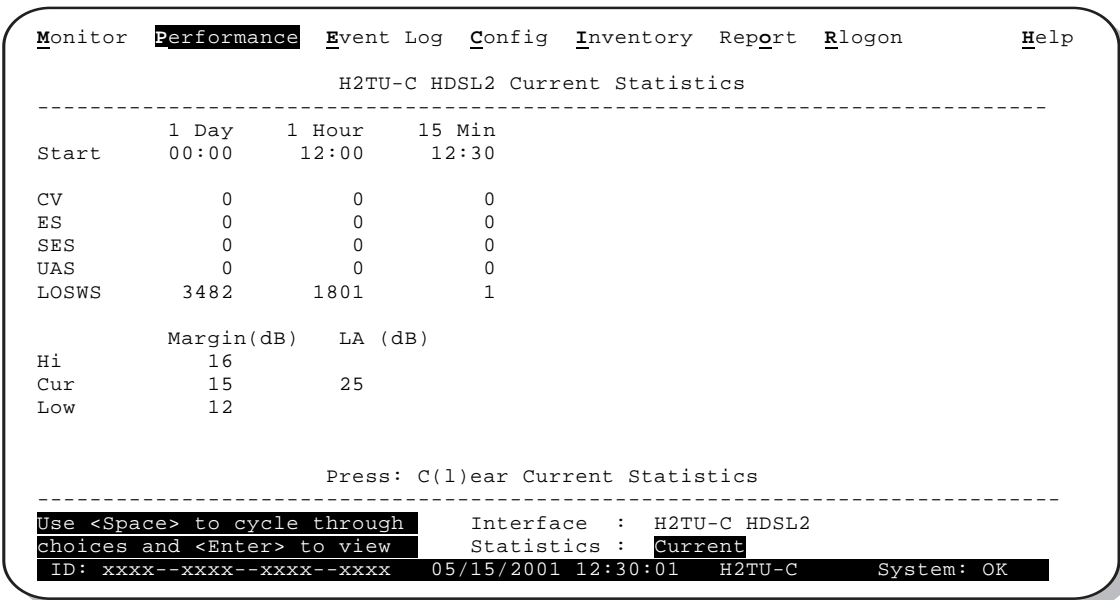

Figure 22. H2TU-C HDSL2 Current Statistics

**Table 14.** *Error Acronyms Used on the HDSL2 Performance History Screens*

<b>Error Acronym</b>	<b>Description</b>
CV	Code Violation Total count of HDSL2 CRC errors.
ES	Errored Seconds Seconds with HDSL2 CRC $\geq 1$ or LOSW $\geq 1$
SES	Severely Errored Seconds Seconds with HDSL2 CRC $\geq 50$ or LOSW $\geq 1$
UAS	Unavailable Seconds Based on 10 contiguous SES occurrences
LOSWS	Loss of Sync Word Second Seconds with LOSW $\geq 1$

## Blockage Indicator Statistics at the H2TU-R HDSL2 Interface

Figure 23 is an example of the BI history screen as viewed from the H2TU-C at the HDSL2 interface. These screens can also be viewed when logged on locally at the remote unit. The BI statistics can also be retrieved using inband or Facility Data Link (FDL) access.

BI is a quality of service (QoS) summary statistic which supplies a quick indicator of circuit performance at the H2TU-R. The BI weighs and averages PM primitives at the H2TU-R's HDSL2 port to provide a relative index of its performance.

BI displays as a percentage for the current hour and for each of the eight preceding hours. After viewing the information, press **R** to return to the H2TU-C logon screen.

```

Monitor Performance Event Log Config Inventory Report Rlogoff Help
                H2TU-R HDSL2 Blockage Indicator History
-----
Time           SPAN-1
02:00         0%
03:00         0%
04:00         0%
05:00         0%
06:00         0%
07:00         0%
08:00         0%
09:00         0%
10:00         0%

                Press: C(1)ear History
-----
Use <Space> to cycle through      Interface : H2TU-R HDSL2
Choices and <Enter> to view       Statistics : BI History
ID: xxxx--xxxx--xxxx--xxxx      05/15/2001 01:35:13 H2TU-R System: OK

```

**Figure 23.** H2TU-R Blockage Indicator History Screen (HDSL2 Interface)

BI is calculated as follows:

$$BI = [(UAS + .4 SES + .2 ES) / MON] \times 100$$

- where:
- BI = 0% indicates the circuit leg is clean.
  - BI = 99% indicates that the circuit leg is out of service.
  - BI = % that is BI < 99% indicates partial trouble in the circuit leg. This percentage is greater than 0% and less than 99%. The higher the BI percentage, the more trouble on that particular circuit leg.
  - MON = indicates the number of seconds that were monitored in obtaining the UAS, SES, and ES data.
  - ES Count of 1-second intervals with HDSL2 CRC  $\geq$  1 or LOSW  $\geq$  1.
  - SES Count of 1-second intervals with HDSL2 CRC  $\geq$  50 or LOSW  $\geq$  1.
  - UAS Unavailable Seconds or line unavailability is declared at the onset of 10 contiguous SES. For the line, including HDSL loops, to become available, there must be a minimum period of 10 seconds which are free of SES.



For information on blockage indicator statistics at the DS1 interface, see “Blockage Indicator Statistics at the H2TU-R DS1 Interface” on page 34.

## USING THE PERFORMANCE SCREENS TO VIEW ALARM DATA

To access the alarm history screens:

- 1 Press **P** to select the Performance screen.
- 2 Press the **SPACEBAR** to select an interface (**H2TU-C DS1**, **H2TU-R DS1**, **H2TU-C HDSL2**, or **H2TU-R HDSL2**), then press **ENTER**.
- 3 Press the **SPACEBAR** until **Alarm History** is selected, then press **ENTER**.
- 4 Press **N** or **P** to page through the alarm history screens.
- 5 Press **L** to clear the selected alarm history screen.

### Alarm History at the DS1 Interface

The Alarm History screen reports DS1 statistics for the H2TU-C, shown in [Figure 24](#) below, and the H2TU-R, shown in [Figure 25 on page 40](#), on a continuous basis. The types of alarms reported are described in [Table 15 on page 40](#). Current alarms are shown in reverse video.

```

Monitor  Performance  Event Log  Config  Inventory  Report  Rlogon      Help
-----
                H2TU-C DS1  Alarm History
-----
Alarm      First          Last          Status      Count
-----
LLOS                          OK           0
LAIS                          OK           0
DBER                          DISABLED     0

                Press: C(l)ear Alarm History
-----
Use <Space> to cycle through  Interface : H2TU-C DS1
choices and <Enter> to view   Statistics : Alarm History
ID: xxxx--xxxx--xxxx--xxxx  05/15/2001 12:30:01 H2TU-C      System: Alarm

```

*Figure 24. H2TU-C DS1 Alarm History Screen*

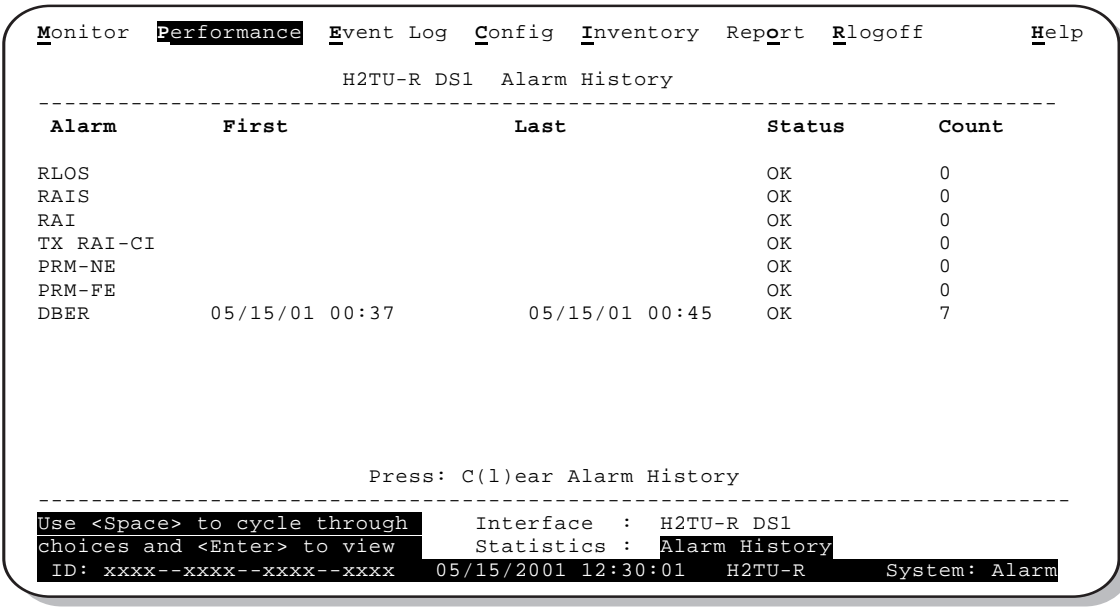

Figure 25. H2TU-R DS1 Alarm History Screen

Table 15. DS1 Alarm Descriptions

Screen Alarm	Front-Panel Alarm	Description
<b>H2TU-C DS1 ALARMS (see Figure 24 on page 39)</b>		
LLOS <sup>(a)</sup>	LLOS	Line (Unit) Loss of Signal—Loss of the H2TU-C DSX-1 input signal.
LAIS	LAIS	Line Alarm Indication Signal—Indicates an AIS (unframed all ones) pattern is being received at the H2TU-C DS1 input port.
DBER	xxx-DBER	Bit Error Rate—The DS1 BER has exceeded the built-in 24-hour threshold limits of approximately 10 <sup>-6</sup> . (xxx denotes either TUC or TUR.)
<b>H2TU-R DS1 ALARMS (see Figure 25 on this page)</b>		
RLOS <sup>(a)</sup>	RLOS	Remote (Unit) Loss of Signal—Loss of the H2TU-R DS1 input signal.
RAIS	RAIS	Remote Alarm Indication Signal—Indicates an AIS (unframed all ones) pattern is being received at the H2TU-R DS1 input port. By default AIS-CI <sup>(b)</sup> is sent toward the network. See Figure 31 on page 51.
RAI	RRAI	Remote RAI - Remote Alarm Indication at the H2TU-R—Indicates an RAI alarm (yellow) from the CPE with errors from the line unit or network.
TX RAI-CI	TRCI	Transmit RAI-CI - Remote Alarm Indication at the H2TU-R—Upon reception of an RAI (yellow alarm) from the CPE, the H2TU-R sends an RAI-CI toward the network if the network signal received at the H2TU-R is clear. If the network signal is impaired (LOS, AIS, or LOF), then the RAI is passed on to the network unaltered. This is applicable to SF or ESF framing. In an all SF environment, RACI must be enabled to convert SF-RAI to SF-RAI-CI.
PRM-NE	PRMN	Performance Report Monitoring - Near End—The count of the PRM-NE register at the H2TU-R exceeds the 10 <sup>-6</sup> BER threshold at 648 events since 12:00:00 AM.
PRM-FE	PRMF	Performance Report Monitoring - Far End—The count of the PRM-FE register at the H2TU-R exceeds the 10 <sup>-6</sup> BER threshold at 648 events since 12:00:00 AM.
DBER	xxx-DBER	Bit Error Rate—The DS1 BER has exceeded the built-in 24-hour threshold limits of approximately 10 <sup>-6</sup> . (xxx denotes either TUC or TUR.)

(a) This is a DS1-specific alarm that also issues a minor alarm (sent to the management unit or the backplane), if enabled.  
 (b) AIS-CI is a modified AIS alarm pattern. Equipment not suited to detect AIS-CI still detects this signal as an AIS. AIS-CI is sent toward the network indicating that an LOS (RLOS) or AIS (RAIS) has been received from the CPE.



## Alarm History at the HDSL2 Interface

The HDSL2 Alarm History screens report alarms at the H2TU-C and the H2TU-R. [Figure 26](#) shows the H2TU-C HDSL2 alarm history. [Table 16](#) describes the alarms that are reported at the H2TU-C or H2TU-R.

```

Monitor Performance Event Log Config Inventory Report Rlogon Help
-----
H2TU-C HDSL2 Alarm History
-----
Alarm          First              Last              Status           Count
-----
LOSW                               OK                0
MAL                               OK                0
LA                               OK                0
HBER          05/15/01 00:37    05/15/01 00:45    OK                7
SHORT                               OK                0
GND                               OK                0
OPEN                               OK                0

-----
Press: C(1)ear Alarm History
-----
Use <Space> to cycle through      Interface : H2TU-C HDSL2
choices and <Enter> to view       Statistics : Alarm History
ID: xxxx--xxxx--xxxx--xxxx    05/15/2001 12:30:01 H2TU-C System: Alarm

```

*Figure 26. H2TU-C HDSL2 Alarm History Screen*

*Table 16. HDSL2 Alarm Descriptions*

Screen Alarm	Front-Panel Alarm	Description
<b>HDSL2 ALARMS at the H2TU-C and H2TU-R</b>		
LOSW	LOSW	Loss of Sync Word—The HDSL2 loop has lost synchronization.
MAL	xxx-MAL	Margin—The margin on the HDSL2 loop has dropped below the minimum threshold value set for the system. (xxx denotes either TUC or TUR.)
LA	xxx-LA	Loop Attenuation—The attenuation on the HDSL2 loop has exceeded the maximum value set for the HDSL2 loop attenuation threshold. (xxx denotes either TUC or TUR.)
HBER	xxx-HBER	Block Error Rate—The HDSL2 BER has exceeded the set threshold limits of $10^{-6}$ or $10^{-7}$ . (xxx denotes either TUC or TUR.)
<b>HDSL2 ALARMS at the H2TU-C only</b>		
SHORT	PWR FEED SHRT	Indicates a short between the Tip and Ring of the HDSL2 pair.
GND	PWR FEED GND	The HDSL2 loop is grounded.
OPEN	PWR FEED OPEN	Indicates a line power open condition.

## USING THE SYSTEM EVENT LOG TO TRACK EVENTS

The System Event Log screen displays the 100 most recent events (the most recent event displayed first) and provides the following information:

- Origin tags to identify the source of a Write entry as shown in “Origin Tags” on page 43
- Date and time
- Event log messages as shown in “Event Log Messages” on page 44

To view a running log of system events, press **E** to select the Event Log.

- Press **N** or **P** to page through the event log.
- Press **T** to return to the top of the log.
- Press **L** to clear the event log.

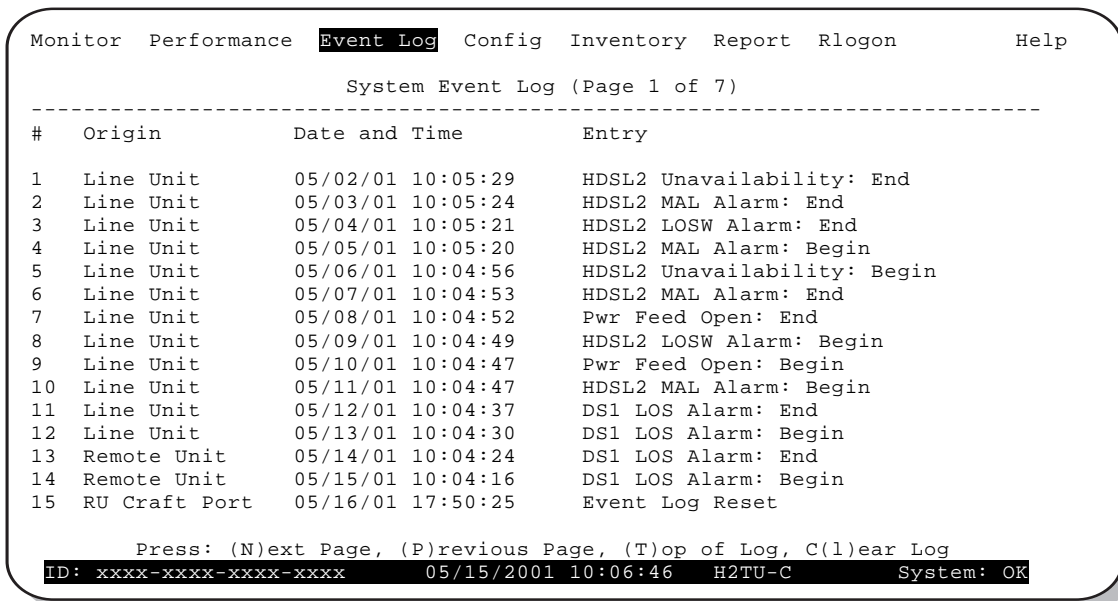

Figure 27. System Event Log Screen

## Origin Tags

The origin tags identify the source of all Write entries and how an event occurred. The exact meaning is dependent on the type of event and the unit reporting the event. A Write entry changes a system parameter or an option setting, but does not affect circuit status changes, such as alarms. Table 17 lists the various origin tags and their definitions.

*Table 17. Origin Tags*

Origin Tag	Description
<b>Provisioning changes initiated at the line unit (logged on to the line unit)</b>	
LU Craft Port	Event was initiated from the RS-232 craft port located on the front panel of the H2TU-C.
LU Front Panel	Event was initiated from the MODE and/or LBK pushbutton on the front panel of the H2TU-C.
Managed Host	Event was initiated from a host management unit, such as an HMU-319, that sent a command over the management bus on the H2TU-C shelf backplane.
<b>Provisioning changes initiated at the line unit (logged on to the remote unit)</b>	
Line Unit	This generic origin tag can only occur when viewing the Event Log screen at the remote unit. It is a general indication that the event was initiated at the line unit. The Event Log screen must then be viewed at the line unit (through an Rlogon command) for more specific origin information.
<b>Provisioning changes initiated at the remote unit (logged on to the remote unit)</b>	
RU Front Panel	Event was initiated from the LBK pushbutton on the front panel of the H2TU-R.
RU Craft Port	Event was initiated from the RS-232 craft port located on the front panel of the H2TU-R.
TL1 Command	Event was initiated by a non-intrusive TL1 command embedded in the FDL of the ESF DS1 signal received by the HDSL2 circuit.
11 Bit Command	Event was initiated by an intrusive command in the DS1 payload received by the HDSL2 circuit.
<b>Provisioning changes initiated at the remote unit (logged on to the line unit)</b>	
Remote Unit	This generic origin tag can only occur when viewing the Event Log screen at the line unit. It is a general indication that the event was initiated at the remote unit. The Event Log screen must then be viewed at the remote unit (through an Rlogon command) for more specific origin information.
<b>Loopback commands</b>	
Remote Unit	Implies that the loopback command was initiated at the remote unit by the front-panel pushbutton, craft port, or in the remote unit's DS1 input payload. A loopback initiated from a terminal would have a Remote Unit tag if the initiating terminal is in a remote logon session.
Line Unit	Implies that the loopback command was initiated at the line unit by the front-panel pushbuttons, craft port, or in the line unit's DSX-1 input payload.
<b>Alarms</b>	
Remote Unit	Indicates that the alarm occurred at the remote unit.
Line Unit	Indicates that the alarm occurred at the line unit. LOSW, SHORT, GND, and OPEN are always tagged as line unit alarms.

## Event Log Messages

Table 18 lists all the possible messages that can be displayed by the System Event Log screen.

**Table 18.** *Event Log Messages*

DS1 Alarm History reset
DS1 PM register reset
HDSL2 Alarm History reset
HDSL2 PM register reset
Loop Down (any segment)
Loop Up (any segment)
Provisioning option change: <provisioning mnemonic>: changed from <old> to <new>
CPE DBER alarm (1-day threshold crossed of any PM data except PRM-NE or PRM-FE)
CPE DS1 AIS begins/ends
CPE DS1 LOS begins/ends
CPE PRM-NE BER alarm (at the remote only: 1-day threshold crossed of PRM-NE: trouble on CPE receive)
Current statistics reset
Event Log reset
H2TU-C Power up/down
H2TU-R Power up/down
HDSL2 DC pair open begins/ends on any segment
HDSL2 Ground fault begins/ends on any segment
HDSL2 HBER alarm (threshold crossed) on any segment.
HDSL2 loop attenuation (threshold crossed) on any HDSL2 Interface
HDSL2 margin alarm (threshold crossed) on any HDSL2 Interface
HDSL2 unavailability begins/ends on any segment
Master zero reset
NTWK DBER alarm (1-day threshold crossed of any PM data)
NTWK DS1 LOS begins/ends
NTWK PRM-FE BER alarm (at the remote only: 1-day threshold crossed of PRM-FE: trouble on NTWK far end)
NTWK DS1 AIS begins/ends
Power Feed Open begins/ends
Power Feed Short begins/ends
RAI begins/ends
TX RAI-CI begins/ends (RAI-CI sent from the remote towards the network)

## USING THE SECTIONALIZED EVENT LOG TO ISOLATE TROUBLE

The Sectionalized Event Log screen, shown in [Figure 28](#), displays the date and time of the 100 most recent sectionalized events for all four legs of the H2TU-R DS1 interface. The screen provides a description of each event with the most recent event displayed first.



The Sectionalized Event Log screen can only be viewed through an **R**logon session from the H2TU-C end, or through a local logon session from the H2TU-R end.

To view the H2TU-R Sectionalized Event Log:

- 1 Press **R** to log on remotely, then press **E**.
- 2 Use the **↑** and **↓** arrow keys to select **Sectionalized Event Log**, then press **ENTER**.
  - Press **N** or **P** to page through the event log.
  - Press **T** to return to the top of the log.
  - Press **L** to clear the event log.
- 3 Press **ESC** to exit the Sectionalized Event Log screen, then press **R** to return to the H2TU-C logon screen.

#	Date and Time	NET-TX	CPE-RX	CPE-TX	NET-RX
1	04/30/01 01:29	ALARM	AIS	AIS	AIS
2	05/01/01 01:29	ALARM	AIS	AIS	ALARM
3	05/02/01 01:26	OK	NOT SECT	OK	NOT SECT
4	05/03/01 01:26	ES	NOT SECT	OK	NOT SECT
5	05/04/01 01:26	OOF	OOF	OOF	OOF
6	05/05/01 01:26	OK	NOT SECT	OK	NOT SECT
7	05/06/01 01:26	OOF	OOF	OOF	OOF
8	05/07/01 21:12	OK	NOT SECT	OK	NOT SECT
9	05/08/01 21:12	OK	NOT SECT	AIS	AIS
10	05/09/01 21:11	ALARM	AIS	AIS	AIS
11	05/10/01 21:11	OOF	OOF	OOF	OOF
12	05/11/01 20:14	OK	OK	OK	OK
13	05/12/01 20:14	OK	NOT SECT	OK	OK
14	05/13/01 20:14	OK	OK	OK	OK
15	05/14/01 20:14	OK	NOT SECT	OK	OK

Press: (N)ext Page, (P)revious Page, (T)op of Log, C(l)ear Log  
 ID: xxxx--xxxx--xxxx--xxxx 05/15/2001 01:35:52 H2TU-R System: Alarm

**Figure 28.** Sectionalized Event Log Screen

Sectionalized events isolate trouble to a particular circuit leg. For example, an ES listed under the NET-TX column indicates that an errored second condition exists on the NET-TX circuit leg beginning with the time stamp and continuing until an OK or other new event is recorded.

Sectionalized events use the status definitions described in Figure 28 on page 45 and in Table 19 on this page.

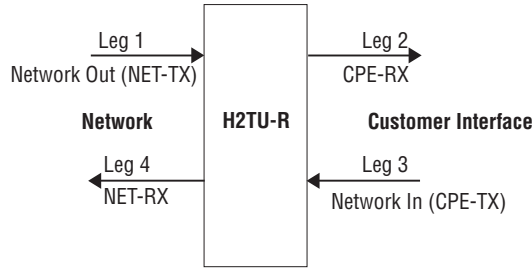

Figure 29. Sectionalized Events

Table 19. Sectionalized Event Definitions

Transmission Leg	Event Name	Event Description
Leg 1 (NET-TX)	Alarm	HDSL2 LOSW or DS1 LOS received from the network
	AIS	AIS received from the network
	RAI	RAI received from the network
	OOF	More than 2 seconds of OOF received
	SES	BPV ≥ 1544, CRC (ESF) ≥ 320, or FE (SF) ≥ 8
	ES	BPV, SEF, CRC (ESF), or FE (SF)
	OK	Leg 1 is clear
Leg 2 (CPE-RX)	Alarm <sup>(a)</sup>	Inferred alarm because RAI is received from the CPE at leg 3 and leg 1 is clear
	AIS	Reported only when remote actively sends out AIS to CPE
	RAI	Leg 1 is in RAI state
	SES <sup>(a)</sup>	Inferred SES. PRM received from CPE has G6 or SE bit set.
	ES <sup>(a)</sup>	Inferred ES. PRM received from CPE has any of G1 through G5 set, LV, or FE set.
	NOT SECT	Cannot be sectionalized; no PRM received from the CPE.
	OK	PRM received from CPE has no errors.
Leg 3 (CPE-TX)	Alarm	LOS received from CPE
	AIS	AIS received from CPE
	RAI	RAI received from CPE
	OOF	More than 2 seconds of OOF received
	SES	BPV + EXZ ≥ 1544 of F (ESF) ≥ 320 or FE (SF) ≥ 8
	ES	BPV, SEF, CRC (ESF), or FE (SF)
	OK	Leg 3 is clear
Leg 4 (NET-RX)	Alarm <sup>(a)</sup>	Inferred alarm because RAI is received from the network at leg 1 and leg 3 is clear
	AIS-CI	Remote actively sends out AIS-CO to the network due to an LOS or AIS at leg 3
	RAI-CI	Remote actively sends out RAI-CI due to leg 3 RAI and leg 1 is clear
	SES <sup>(a)</sup>	Inferred SES. PRM received from CPE has G6 or SE bit set.
	ES <sup>(a)</sup>	Inferred ES. PRM received from CPE has any of G1 through G5 set, LV, or FE set.
	NOT SECT	Cannot be sectionalized; no PRM received from the CPE.
	OK	PRM received from CPE has no errors.

(a) An inferred failure or error condition displays in reverse video on the monitor.

## USING THE REPORT MENU

The Report menu (Figure 30) provides screens containing status and performance monitoring data for line and remote units which can be downloaded to a file for analysis or future reference. Table 20 on page 48 describes the four types of reports provided by the Report menu.

To select each individual report, do the following:

- 1 Press **O** to select Report menu.
- 2 Press the **SPACEBAR** to select a report.
- 3 Use your terminal emulation software (HyperTerminal or Procomm) to capture the selected report to your printer or to a file. Press **ENTER** to generate.
- 4 End the captured report.
- 5 Press **CTRL + R** to refresh the Report menu screen.

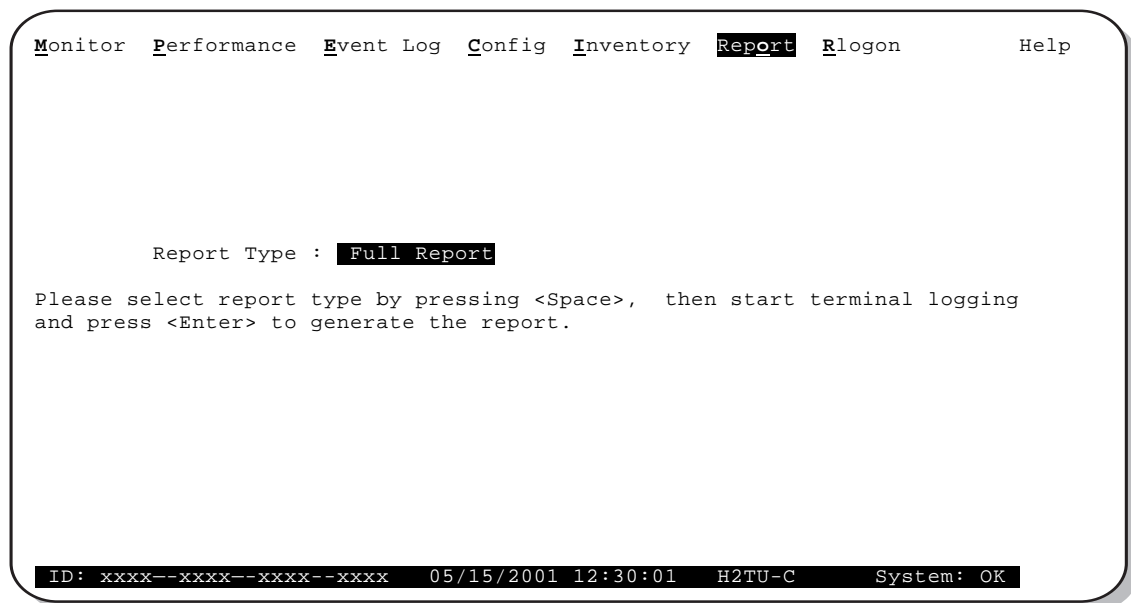

*Figure 30. Report Menu - Full Report*

**Table 20. Report Types**

<b>Type</b>	<b>Contains the following information:</b>
Full Report	<ul style="list-style-type: none"><li>• Circuit and unit identifications</li><li>• Product information</li><li>• System configuration</li><li>• Current performance statistics</li><li>• Alarm history</li><li>• Performance history</li><li>• System event log</li></ul>
Short Report	<ul style="list-style-type: none"><li>• Circuit and unit identifications</li><li>• Product information</li><li>• System configuration</li><li>• Current performance statistics</li></ul>
System Information Report	<ul style="list-style-type: none"><li>• Circuit and unit identifications</li><li>• Product information</li><li>• System configuration</li></ul>
Event Report	<ul style="list-style-type: none"><li>• Circuit and unit identifications</li><li>• Product information</li><li>• System event log</li></ul>



# TESTING

This section provides information about front-panel system alarms, LOS and AIS response, OCT55 test procedure, and loopback testing.

## SYSTEM ALARMS

Table 21 summarizes all possible HDSL2 system alarms in order of priority as they appear on the front panel. When multiple alarms occur, the front-panel display only reports the highest priority alarm. The alarm history screens display alarms also, but provide greater detail. See “Using the Performance Screens to View Alarm Data” on page 39. Alarms that are not inhibited will drive the front-panel Status LED to a flashing red alarm state.

**Table 21.** Front-Panel System Alarms Summary

Front-Panel Message <sup>(a)</sup>	Alarm	Description	To Inhibit
PWR FEED SHRT <sup>(b)</sup>	Power Feed Short	A short exists between the Tip and Ring of the HDSL2 pair.	Cannot be inhibited.
PWR FEED GND <sup>(b)</sup>	Power Feed Ground	The HDSL2 loop is grounded.	Cannot be inhibited.
PWR FEED OPEN <sup>(b)</sup>	Power Feed Open	A line power open condition exists.	Cannot be inhibited.
LOSW <sup>(c)</sup>	Loss of Sync Word	The HDSL2 loop has lost synchronization.	Cannot be inhibited.
LLOS <sup>(c)</sup>	Line (Unit) Loss of Signal	Loss of the DSX-1 input signal.	Cannot be inhibited.
RLLOS <sup>(c)</sup>	Remote (Unit) Loss of Signal	Loss of the H2TU-R DS1 input signal.	Cannot be inhibited.
LAIS	Line Alarm Indication Signal	Indicates an AIS (unframed all ones) pattern is being received at the H2TU-C DS1 input port.	Cannot be inhibited.
RAIS	Remote Alarm Indication Signal	Indicates an AIS (unframed all ones) pattern is being received at the H2TU-R DS1 input port.	Cannot be inhibited.
TRCI	Transmit RAI-CI—Remote Alarm Indication at the H2TU-R	Upon reception of an RAI (yellow alarm) from the CPE, the H2TU-R sends RAI-CI toward the network if the network signal received at the H2TU-R is clear.  If the network signal is impaired (LOS, AIS, or LOF), then the RAI is passed on to the network unaltered.	Cannot be inhibited.
RRAI	Remote RAI—Remote Alarm Indication at the H2TU-R	Indicates an RAI alarm (yellow) from the CPE with errors from the line unit or network.	Cannot be inhibited.
xxx-DBER	DS1 Bit Error Rate	The DS1 BER has exceeded the set threshold limits of approximately $10^{-6}$ . xxx denotes either TUC or TUR. If TUC and TUR occur at the same time, then TUC displays.	Select DIS for the DBER system option.
PRMF	Performance Report Messaging - Far End	Indicates H2TU-R PRM-FE BER threshold is exceeded.	Set DBER threshold to DIS.
PRMN	Performance Report Messaging - Near End	Indicates H2TU-R PRM-NE BER threshold is exceeded.	Set DBER threshold to DIS.
xxx-HBER <sup>(c)</sup>	HDSL2 Block Error Rate	The HDSL2 BER has exceeded the set threshold limits of $10^{-6}$ or $10^{-7}$ . xxx denotes either TUC or TUR. If TUC and TUR occur at the same time, then TUC displays.	Select NONE for the HBER system option.

*Continued*

**Table 21.** *Front-Panel System Alarms Summary (Continued)*

Front-Panel Message <sup>(a)</sup>	Alarm	Description	To Inhibit
xxx-MAL <sup>(b)</sup>	Margin Alarm	The margin on the HDSL2 loop has dropped below the minimum threshold value set for the system. xxx denotes either TUC or TUR. If TUC and TUR occur at the same time, then TUC displays.	Set the Margin Alarm Threshold option to 0 (zero).
xxx-LA <sup>(b)</sup>	Loop Attenuation	The attenuation on the HDSL2 loop has exceeded the maximum value set for the HDSL2 loop attenuation threshold. xxx denotes either TUC or TUR. If TUC and TUR occur at the same time, then TUC displays.	Set the HDSL2 Loop Attenuation Threshold option to zero.

(a) The message, ALRM, displays prior to any alarm message.

(b) Message displays repeatedly as long as the alarm condition exists and is not included in the priority order.

(c) Only these alarms assert the System Alarm bus on pins 30 and 22 of the card-edge connector if the ALM option is enabled.

(d) When the HDSL2 loop loses sync word (LOSW), a system alarm condition exists. However, since the H2TU-C-202 List 2F enters the acquiring mode, the front-panel status LED flashes red, and the ACQ or SIG message displays instead of the ALRM message.

## Alarm Option for Digital Loop Carrier Feed

To improve HiGain HDSL2 compatibility with the switch-to-protect features used in Digital Loop Carrier (DLC) feeder applications, the H2TU-C-202 List 2F has an Alarm Pattern (ALMP) option that allows you to select either an AIS or LOS DS1 output payload for the following alarms:

- LOSW on any loop
- LOS DS1

## Retiring System Alarms

To retire a system alarm, press the LBK pushbutton to execute an Alarm Cutoff (ACO). An ACO turns the alarm off and replaces the ALRM message with an ACO message. The second part of the ALRM message, which defines the cause of the alarm, remains. Both parts of the message remain until the alarm condition clears or another higher priority alarm occurs.

## Remote LOS and AIS Response

Figure 31 shows the different ways the H2TU-R can respond to the network, depending on the configuration of the TLOS, NLBP, RDA, ALMP, and NAIS configuration options described in Table 5 on page 16 and Table 6 on page 17.

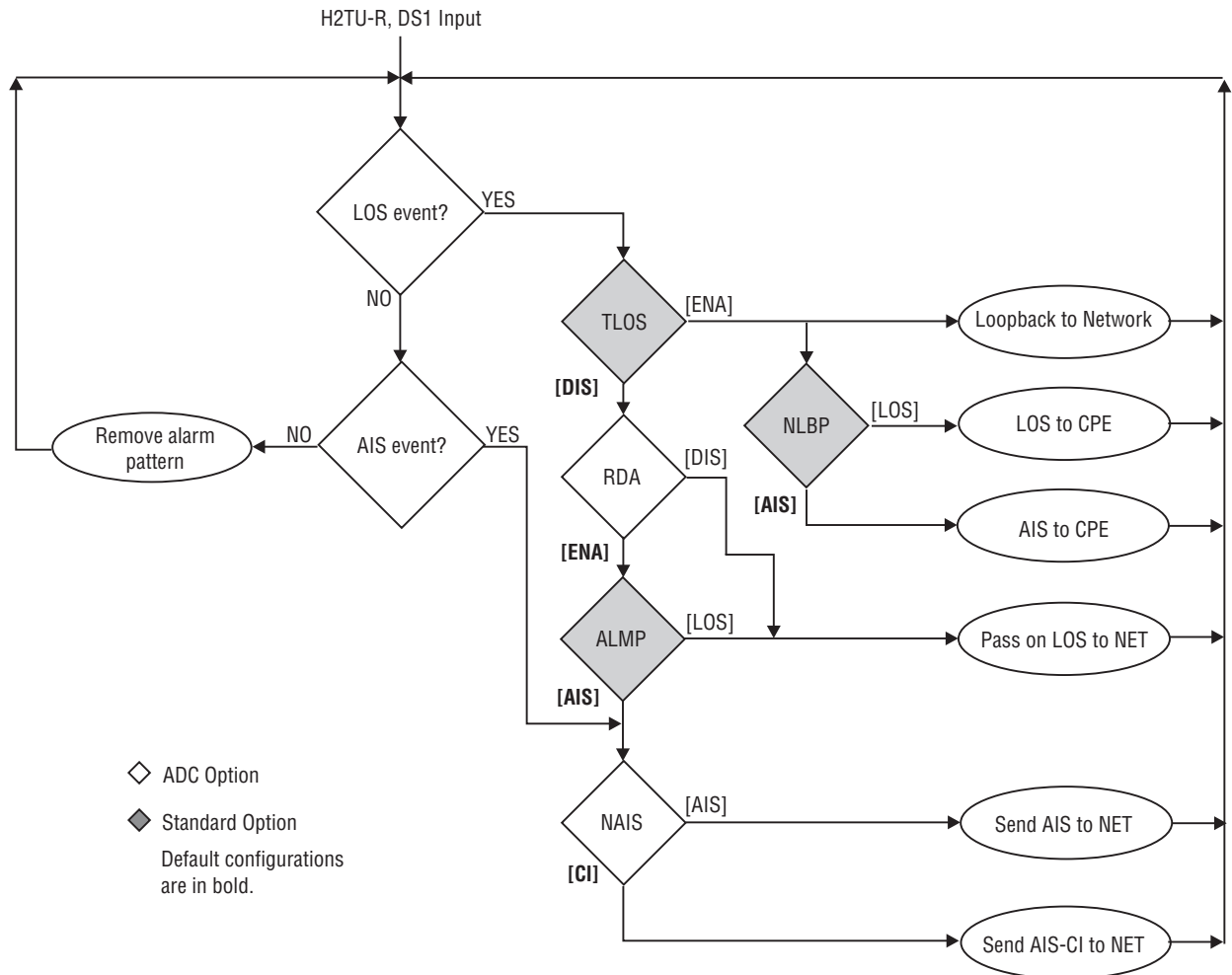

Figure 31. H2TU-R LOS and AIS Response Priorities

## OCT55 TEST PATTERN WITH AMI CODE

The OCT55 test pattern can be used in unframed mode to stress the system and verify data integrity without creating any line errors. When a framed OCT55 test pattern is used, excessive zero anomalies may occur which cause the H2TU-C to report ES, SES, and UAS errors according to ANSI T1.202-1997.

## LOOPBACK OPERATION

HiGain HDSL2 has a family of loopback options for analyzing circuit functionality. The loopback signal is transmitted and returned to the sending device for comparison. This allows you to verify the integrity of the HDSL2 channels to the H2TU-C, the H2TU-C DSX-1 interface, and the DS1 channels to the customer. Loopback options include:

- Generic Loopback (GNLB) options, including the SmartJack (SMJK) option and double loopbacks (see [Table 22 on page 53](#))
- Special Loopback (SPLB) options (see “[Special Loopback Commands](#)” on page 54) and the following command tables:
  - Addressable Repeater Loopback commands: A1LB, A2LB, A5LB (see [Table 23 on page 58](#))
  - Addressable Repeater Loopback commands: A3LB, A4LB (see [Table 24 on page 60](#))

Loopback commands can be initiated by:

- Selecting the loopback type using the MODE and LBK pushbuttons on the H2TU-C front panel or the manual loopback (LBK) pushbutton on the H2TU-R
- Selecting the loopback type from the Monitor menu when connected to the craft port of the H2TU-C or H2TU-R
- Entering the loopback code (exceptions are COLB and RULB) into the test equipment connected to the H2TU-C or H2TU-R.

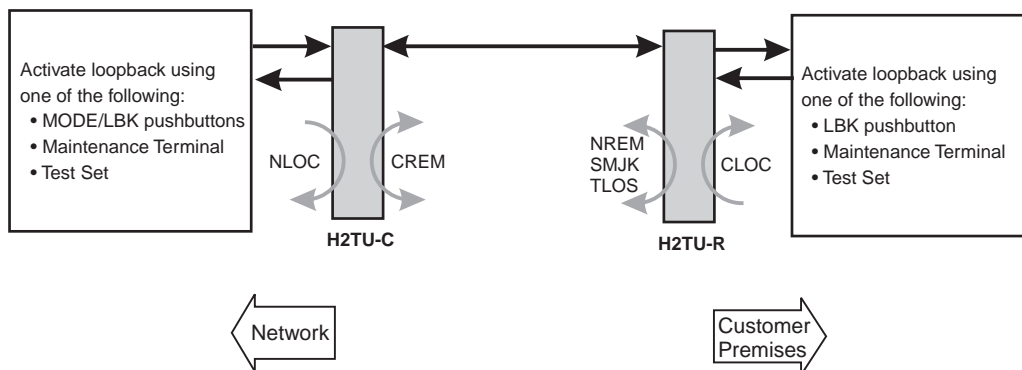

*Figure 32. Loopback Summary*



**HiGain HDSL2 supports multiple loopbacks, but a single loopback is the preferred method.**

## GENERIC LOOPBACK COMMANDS

The HiGain Generic Loopback (GNLB) commands allow you to use inband codes to loop up either NLOC (4-in-7) or NREM (3-in-7) toward the network. In addition, these inband codes loop up CREM (6-in-7) or CLOC (5-in-7) toward the customer. Either loopup condition can be terminated (looped down) with the 3-in-5, SMJK loopdown code. All inband codes must be present for at least 5 seconds before the HiGain HDSL2 system responds. TLOS is a logic loopback caused by loss of the DS1 input from the CI.

Figure 33 on page 57 summarizes the available loopbacks in the system, and Table 22 on this page summarizes the HiGain HDSL2 generic loopback commands. See “GNLB Test Procedures” on page 56 for the test procedures that apply when using the GNLB mode.

**Table 22.** Summary of HiGain HDSL2 Loopback Codes and Activation Methods

Loopback	Code	Description	Method of Activation		
			Test Set	Craft Port	MODE/LBK
NLOC	1111000 4-in-7	DSX-1 signal is looped back to the network at the H2TU-C.	X	X	X
NREM	1110000 3-in-7	DSX-1 signal is looped back to the network at the H2TU-R.	X	X	X
CLOC	1111100 5-in-7	DS1 signal from the customer is looped back to the customer at the H2TU-R.	X	X	X
CREM	1111110 6-in-7	DS1 signal from the customer is looped back to the customer at the H2TU-C.	X	X	X
COLB		Dual loopback at the H2TU-C. DSX-1 signal is looped back to the network at the H2TU-C and signal from the customer is looped back to the customer at the H2TU-C.		X	X
RULB		Dual loopback at the H2TU-R. DSX-1 signal is looped back to the network at the H2TU-R and signal from the customer is looped back to the customer at the H2TU-R.		X	X
SMJK LpUp (PL)	11000 2-in-5	SmartJack Loopup or NID payload (PL) code. Invokes H2TU-R loopback toward network.	X		
SMJK LpUp (ESF-DL)	1111-1111-0100-1000	SmartJack Loopup or NID (ESF-DL) code. Invokes H2TU-R loopback toward network.	X		
SMJK LpDn (PL)	11100 3-in-5	SmartJack Loopdown or NID payload (PL) code. Removes SMJK, NLOC, NREM, CLOC, and CREM.	X		
SMJK LpDn (ESF-DL)	1111-1111-0010-0100	SmartJack Loopdown or NID (ESF-DL) code. Removes SMJK, NLOC, NREM, CLOC, and CREM.	X		



HiGain systems feature the SmartJack option which can emulate a Network Interface Device (NID) for loopback testing of the HiGain HDSL2 circuit. SMJK and NREM loopbacks perform the same functions, but their initiation differs. SMJK indicates that the loopback was initiated by the 2-in-5 inband command. NREM, on the other hand, is initiated by the 3-in-7 inband command, or by a command issued from the maintenance terminal.

Use the inband commands to enable or disable the SMJK loopback options. The H2TU-C-202 system setting is normally enabled to recognize all inband SmartJack loopback commands.

## SPECIAL LOOPBACK COMMANDS

In addition to the GNLB loopback command mode, a HiGain HDSL2 system can be configured for special loopback command modes. From the maintenance terminal Monitor screen, you can configure the unit using the Config menu and Special Loopback Mode option. Once a loopback mode is activated, other loopback commands can be sent by a test set connected to the craft port of the H2TU-C or H2TU-R. See [Table 23 on page 58](#) and [Table 24 on page 60](#) for list of SPLB commands.

A1LB through A5LB are five special, addressable, repeater loopback modes which are supported by the H2TU-C-202. These loopback modes provide the HiGain HDSL2 system with sophisticated maintenance and troubleshooting tools. A1LB, A2LB, and A5LB are patterned after the Westell addressable DS1 repeater loopbacks. A3LB and A4LB are patterned after the Wescom addressable DS1 repeater loopbacks. All five SPLBs have been enhanced to handle the specific requirements of the following HiGain HDSL2 customers:

- A1LB (Westell) = Southwestern Bell
- A2LB (Westell) = Southwestern Bell
- A3LB (Wescom) = New England Telephone
- A4LB (Wescom Mod 1) = New York Telephone
- A5LB (Westell Mod 1) = Southern New England Telephone (SNET), Southwestern Bell, Pacific Bell

The A1LB loopback selection complies with that proposed for HDSL2 systems in the DS1-E1.4/92 recommendation with the following additions:

- Query loopback
- IOR (Intelligent Office Repeater) power-down
- Four loopback time-out choices
- Initiation from either end
- Repeating bit error signatures
- Alternate query loopback

These additions make A1LB identical to A2LB. A1LB is given a separate identity to allow future DS1/E1 enhancements to be added without affecting A2LB.

A5LB differs from A2LB in that A5LB does not block the arming code from exiting the H2TU-C-202 List 2F into the network. A1LB and A2LB can be configured to do one of the following:

- Block the arming code (after 2 seconds) from exiting the H2TU-C into the network and replace it with the AIS code.
- Unblock the AIS code by executing the Far End Activate code. Since A5LB never blocks the arming code from exiting the H2TU-C, the Far End Activate code is not available in A5LB.

A3LB differs from A4LB in that A3LB supports the additional (1-in-6) SMJK loopback command.

## MANUAL LOOPBACK SESSION

A manual loopback session allows you to select any one of the HiGain HDSL2 loopbacks listed in [Table 22 on page 53](#) with the exception of SmartJack loopbacks, which can only be issued by inband commands.

### Setting the Loopback Time-Out Option

Before initiating a loopback session, verify that the Loopback Time-Out parameter is set to the desired setting. [Table 5 on page 16](#) describes this option.

- 1 Log on to the maintenance terminal screens.
- 2 Select **Config, Standard Options**, then **LBTO**.
- 3 Verify the LBTO setting.

### Activating Manual Loopback Mode



With the exception of SmartJack, any of the HiGain HDSL2 loopbacks can be executed using the **MODE** and **LBK** pushbuttons.

When executing a manual loopback session using the **MODE** and **LBK** pushbuttons:

- The next loopback option can be displayed by pressing the **MODE** pushbutton, however, the previously activated loopback remains active until the **LBK** pushbutton is pressed, which activates the new loopback.
- If neither pushbutton is pressed for a period of 30 seconds and no loopback is in effect, the manual loopback session terminates, and the display returns to normal mode.
- If any loopback is in effect, the 30-second time-out is inhibited. The active loopback and the manual loopback sessions continue until the loopback times out in accordance with the **LBTO** setting.
- If there is an active loopback, pressing the **MODE** and **LBK** pushbuttons for 5 or more seconds terminates any active loopback, ends the manual loopback session, and returns the display to normal mode.

To initiate a manual loopback session:

- 1 Press both the **MODE** and **LBK** pushbuttons on the front panel for at least 5 seconds. The following message appears on the front-panel display:
 

```
MAN LPBK NLO?
```
- 2 Press **LBK** to activate **NLOC**. The display changes to `MAN LPBK NLOC`.
- 3 Press **MODE** to advance to the next available loopback:
  - `NRE? = NREM`
  - `CRE? = CREM`
  - `CLO? = CLOC`
  - `COL? = dual loopback at H2TU-C`.
  - `RUL? = dual loopback at H2TU-R`.
- 4 Press **LBK** to activate the selected loopback. The previous loopback is terminated.

Once a loopback is selected and activated, the loopback stays active until it times out (based on the **LBTO** setting). When a loopback times out, the display returns to the normal display mode.

You can terminate loopbacks manually and exit the MAN LPBK mode by simultaneously pressing the MODE and LBK pushbuttons for 3 or more seconds. If no loopback is active, the MAN LPBK mode automatically terminates after 30 seconds.

All loopbacks, except dual loopbacks, can be activated by inband commands in the DS1 payload. Loopbacks can also be activated by a command from the HiGain HDSL2 system using front-panel pushbuttons or maintenance screen selections. Therefore, whenever a loopback is active, the method by which it was activated is indicated in the Monitor screen by the annotation HG or PL adjacent to the identified loopback. For example, NREM-HG indicates that the loopback was initiated by the HiGain HDSL2 system. NREM-PL indicates that the loopback was initiated by in-band payload commands.



**SMJK loopback commands are only activated by inband commands. Dual loopback commands are only activated by the front-panel pushbuttons or maintenance screen selections.**

## LOOPBACK TEST PROCEDURES

The following sections provide step-by-step test procedures for verifying the integrity of the HDSL2 channels at every module location as well as the DS1 channels to the customer and the local DSX-1 interface.

### General Troubleshooting Tips

If trouble is encountered on the DSX-1 interface of the H2TU-C, verify that the:

- H2TU-C is making a positive connection with its mounting assembly (shelf) connector.
- H2TU-C internal equalizer is set to the correct distance range per [Table 5 on page 16](#). All equalizers should be set to the distance from the DSX-1 to the shelf.

Transmit and receive front panel bridging jacks allow both DS1 payload directions to be monitored.

### GNLB Test Procedures

[Figure 33 on page 57](#) is a graphical representation of the loopback configurations with the associated GNLB commands. [Table 22 on page 53](#) provides a description of these commands.

To perform the GNLB loopback test procedure:

- 1 Have the CO tester send the NREM (3-in-7) inband loopup code for 5 seconds. You should be able to observe the NREM message on the front-panel display. The Status LED on the front panel should be green, and the loopback mode should also be identified on the Monitor screen.
- 2 Have the CO tester transmit a DS1 test signal toward the H2TU-C and verify that the returned (looped) signal to the test set is error-free.
- 3 If step 2 fails, have the CO tester transmit the 3-in-5 inband loopdown code.



- 4 Have the CO tester send the NLOC (4-in-7) inband loopup for 5 seconds. You should be able to observe the NLOC message on the front-panel display. The Status LED on the front panel should be yellow, and the loopback mode should also be identified on the Monitor screen.
- 5 Repeat Step 2. If the test passes, the problem is in the downstream direction. If it fails, the problem is in the upstream direction.

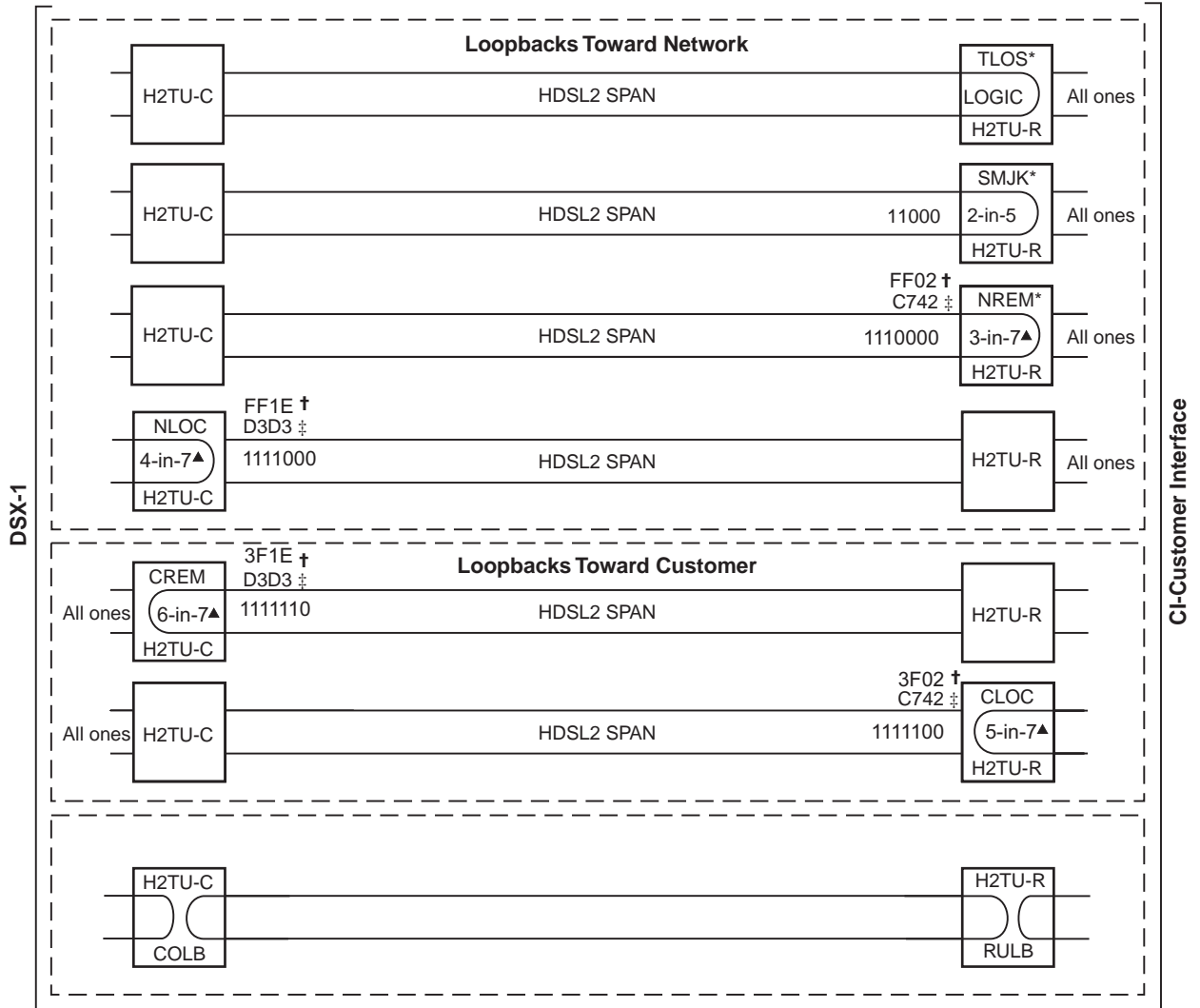

\* Set the NLBP option to AIS to send AIS (indicated by an all ones pattern) for any network loopback.

† A3LB and A4LB loopback codes.

‡ A1LB, A2LB, and A5LB loopback codes.

▲ GNLB loopback codes.

Figure 33. Loopback Modes

## A1LB, A2LB, and A5LB Test Procedures

Using the codes listed in [Table 23](#), a network tester can activate NLOC or NREM loopbacks (or SMJK, if enabled). A tester at the customer premises can activate CLOC or CREM loopbacks.

Use the test procedure for verifying the integrity of the HDSL2 channels at every module location as well as the DS1 channels to the customer and the local DSX-1 interface.

**Table 23.** *Addressable Repeater Loopback Commands (A1LB, A2LB, A5LB)*

Loopback	Binary Code <sup>(a)</sup> (Hexadecimal Equivalent)	Description
ARMING or NI LPBK (inband)	11000-11000 ...	Arming code
ARMING or NI LPBK (ESF Data Link)	1111-1111-0100-1000 (FF48)	Arming code
IR LPDN or DISARM (inband)	11100-11100 ...	Disarming code
IR LPDN or DISARM (ESF Data Link)	1111-1111-0010-0100 (FF24)	Disarming code
IOR LPBK (NLOC and CREM) 230-232 bit errors and 229-231 bit errors <sup>(b)</sup>	1101-0011-1101-0011 (D3D3)	NLOC—DSX-1 signal is looped back to the network at the H2TU-C. CREM—DS1 signal from customer is looped back to the customer at the H2TU-C.
ILR-2 LPBK (NREM or CLOC) 20 bit errors <sup>(c)</sup>	1100-0111-0100-0010 (C742)	NREM—DSX-1 signal is looped back to the network at the H2TU-R. CLOC—DS1 signal from customer is looped back to the customer at the H2TU-R.
IR LPDN (except SMJK)	1001-0011-1001-0011 (9393)	Loopdown (H2TU-C or H2TU-R)
IR QUERY LPBK	1101-0101-1101-0101 (D5D5)	Query loopback
IR ALTERNATE QUERY LPBK	1101-0101-1110-1010 (D5EA)	Alternate query loopback
TIME-OUT OVERRIDE	1101-0101-1101-0110 (D5D6)	Loopback time-out override
FAR END NI ACTIVATE (A1LB and L2LB only) <sup>(d)</sup>	1100-0101-0101-0100 (C554)	Unblock AIS
IOR POWER DOWN (H2TU-C) <sup>(e)</sup>	0110-0111-0110-0111 (6767)	Removes HDSL2 line power

- (a) The leftmost bit arrives first in all sequences. The detection algorithm functions reliably with a random 10-3 Bit Error Rate (BER) on the facility. The entire arming and loopback sequence can also be initiated at the remote H2TU-R location.
- (b) The H2TU-R identifies CREM and the H2TU-C identifies NLOC with 231 bit errors, excluding the frame bits. When framed data is being sent in the AUTO framing mode, the number of the 231 bit errors detected by the test set varies from 229 to 231, depending on whether the test set counts frame errors as bit errors, and on the number of frame bits as data bit errors will indicate fewer bits than the H2TU-R and H2TU-C transmit for a CI and NI loopback.
- (c) The H2TU-R is assigned the ILR-2 loopback code. It responds with 20 bit errors (excluding the frame bits).
- (d) Allows the NIU Activate Command that originates at the H2TU-R to pass through inhibited toward the network and is always enabled. No option to disable.
- (e) The IOR Power Down code must remain present for the duration of the power down mode. When this code is removed, the HiGain HDSL2 system returns to its normal unlooped and unarmed state.



For information regarding the 16-bit DBDB command for retrieving information on the circuit's margin and loop attenuation, see [“Payload Retrieval of Margin and Loop Attenuation Parameters”](#) on page 27.

To perform the A1LB, A2LB, and A5LB loopback test procedures:

- 1 Send the inband Arming and NI LPBK code 11000 to the H2TU-C for at least 5 seconds.
- 2 Monitor the output of the H2TU-C for the return of the pattern. Return of the pattern indicates one of the following:
  - The H2TU-R has looped up, if the SMJK Loopback option is enabled.
  - An external NID has looped up, if the SMJK Loopback option is disabled and the H2TU-C and H2TU-R have been armed.
- 3 Verify, if possible, that the H2TU-R Loopback LED is either flashing yellow at four times per second intervals (indicating that the system is armed), or is a steady yellow (indicating that it is both armed and in SMJK loopback). The H2TU-C Status LED also flashes yellow when the system is armed.



**If the Arming code is not returned after 5 seconds, the system may be armed, but there is no active loopback.**

- 4 Once armed, the H2TU-C can be looped back by sending Intelligent Office Repeater (IOR) LPBK activation code 1101-0011-1101-0011 (D3D3) for at least 5 seconds. You should observe the following activation response pattern in the order presented:
  - a 2 seconds of AIS (an all ones pattern)
  - b 2 seconds of returning data pattern
  - c Logic errors (including the frame bit) occurring in the returned pattern comprising:
    - 231 errors, if IOR LPBK (H2TU-C) was sent
    - 20 errors, if ILR-2 (H2TU-R) was sent
  - d Normal looped data

This error pattern repeats every 20 seconds as long as the IOR loopback pattern is being sent. This also applies to ILR, Time-Out Override, and Query commands.

The H2TU-C is now in logic loopback if the IOR NLOC loopback command was sent. The Time-Out Override command or a Loopdown command can override the selection made for the loopback time-out. If the Time-Out Override code 1101-0101-1101-0110 (D5D6) is received after activating a loopback, then the automatic timed expiration of the loopback is inhibited. If this Time-Out Override is sent, then the only method to loop the H2TU-C down is one of the following:

- Issue the IR loopdown (LPDN) code 1001-0011-1001-0011 (9393)
- Issue the NI LPDN and Disarm inband code 11100 or the ESF-DL code (FF24).



**The Time-Out Override function is only valid for the current active loopback. The automatic time-out timer is restored during subsequent loopback sessions.**

- 5 Once the test is complete, do one of the following:
  - If the system is to loop down but remain Armed, send the IR LPDN code.
  - If all the equipment is to be looped down, disarmed, and returned to normal operation, send the disarm inband code 11100 or the ESF-DL code (FF24).



The Armed mode has an automatic time-out of 120 minutes, but this timer is reset to 120 for any of the following events:

- Loopback terminates (manually or time-out)
- Query
- Alternate query
- Far End activate
- Another ARM command

This timer is inhibited while any of the valid command codes are being sent. Once the codes are removed, the timer restarts at 120.

## A3LB and A4LB Test Procedures

The H2TU-C-202 List 2F can be looped back by sending the Addressable Office Repeater (AOR) LPBK activation code 1111-1111-0001-1110 (FF1E) for at least 5 seconds. This causes the H2TU-C to enter the NLOC state. The Loopback Time-Out setting determines the duration of this loopback unless it is overridden by the reception of a second identical 16-bit loopup command before the timer expires. When this time-out override state exists, the only method to loop the H2TU-C down is to issue one of the three loopdown commands listed in Table 24 below. The automatic time-out mode is restored during subsequent loopback sessions.

Table 24 summarizes the codes required to execute Addressable 3 and 4 (A3LB and A4LB) repeater loopback commands. All code sequences must be present for at least 5 seconds.

**Table 24.** Addressable Repeater Loopback Commands (A3LB and A4LB)

Name	Binary Code <sup>(a)</sup> (Hexadecimal Equivalent)	Description
NLOC	1111-1111-0001-1110 (FF1E)	H2TU-C loopup from NI
CREM	0011-1111-0001-1110 (3F1E)	H2TU-C loopup from CI
NREM	1111-1111-0000-0010 (FF02)	H2TU-R loopup from NI
CLOC	0011-1111-0000-0010 (3F02)	H2TU-R loopup from CI
SMJK	11000-11000-11000 ...	H2TU-R loopup from NI
SMJK	100000 100000 100000 ...	H2TU-R loopup from NI <sup>(b)</sup>
SMJK	1111-1111-0100-1000 (FF48)	H2TU-R loopup from NI (ESF-DL)
Loopdown	11100-11100-11100 ...	H2TU-C and H2TU-R loopdown from NI OR CI
Loopdown	100-100-100 ...	H2TU-C and H2TU-R loopdown from NI OR CI
Loopdown	1111-1111-0010-0100 (FF24)	H2TU-C and H2TU-R loopdown from NI OR CI (ESF-DL)

(a) The leftmost bit arrives first in all sequences. The detection algorithm functions reliably with a random  $10^{-3}$  Bit Error Ratio (BER) on the facility. The entire arming and loopback sequence can also be initiated at the remote H2TU-R location.

(b) Not supported by A4LB.

## TESTING WITH THE H2TU-R SIGNAL GENERATOR

The H2TU-R Signal Generator screen allows transmission of a test signal from the H2TU-R toward either the CI or the network.

- 1 Press **R** to logon remotely, then press **C** to select the Config menu.
- 2 Use the **↑** and **↓** arrow keys to select **Signal Generator** and press **ENTER**.
- 3 Use the arrow keys to select an option and press the **SPACEBAR** to cycle through the available settings. Refer to [Table 25](#) for a list of signal generator option settings.
- 4 Press **ENTER** to activate your choice.
- 5 Press **R** to return to the H2TU-C logon screen. You can exit the Signal Generator screen while signal generation is active.

```

Monitor Performance Event Log Config Inventory Report Rlogoff Help
+-----+
| Standard Options -> |
| ADC Options -> |
| Signal Generator -> |
+-----+
| Test Signal Generator : OFF |
| Test Signal Pattern : ALL 1 |
| Test Signal Linecode : AMI |
| Test Signal Direction : NET & CPE |
| Test Signal Framing : SF |
+-----+

Use <Spacebar> to cycle through option settings and <Enter> to activate
ID: xxxx--xxxx--xxxx--xxxx 05/15/2001 12:30:01 H2TU-R System: OK

```

**Figure 34.** H2TU-R Signal Generator Screen

**Table 25.** Signal Generator Option Settings

Option	Settings
Test Signal Generator	On or Off
Test Signal Pattern	All ones, all zeroes, $2^{23-1}$ pseudo random, $2^{20-1}$ pseudo random, $2^{15-1}$ pseudo random, 1:7 pattern, 2:8 pattern, 3:24 pattern
Test Signal Linecode	AMI or B8ZS
Test Signal Direction	Toward CPE or toward NET & CPE only
Test Signal Framing	SF, ESF, UNFR

# APPENDIX A - SPECIFICATIONS

## Power

HDSL2 Span Voltage	0 or -180 Vdc $\pm$ 5 Vdc
CO Supply	-48 Vdc nominal (-42.5 to -56.5 Vdc) See "Power Consumption" and "Maximum Power Dissipation" and "Maximum Current Drain" on page 63.
Electrical Protection	Secondary surge and power cross protection on HDSL2 ports. Requires external primary protection.
Fusing	Internal; connected to fuse alarm output on pin 25

## Environmental

Operating Temperature	-40°F to +149°F (-40°C to +65°C)
Operating Humidity	5% to 95% (non-condensing)

## Physical

Height	5.6 in. (14.22 cm)
Width	0.7 in. (1.7 cm)
Depth	5.6 in. (14.22 cm)
Weight	1 lb., 2 oz. (.51 kg)
Mounting	200 and 400 mechanics, high-density shelves

## HDSL2

Line Rate	1.552 Mbps Overlapped Pulse Amplitude Modulation Transmission with Interlocking Spectra (OPTIS)
Transmission	full-duplex
Media	One non-loaded, copper, two-wire cable pair
Output	+16.8 dBm $\pm$ 0.5 dBm at 135 $\Omega$ (0-450 kHz) at CO side +16.5 dBm $\pm$ 0.5 dBm at 135 $\Omega$ (0-350 kHz) at remote side
Line Impedance	135 $\Omega$
Maximum Insertion Loss	35 dB at 196 kHz
Maximum Loop Attenuation	28 dB
Start-up Time	30 sec. (typical), 1 min. (maximum) per span

## DSX-1

Line Impedance	100 $\Omega$
Line Rate	1.544 Mbps $\pm$ 200 bps
Line Format	Alternate Mark Inversion (AMI) or Bipolar with 8-Zero Substitution (B8ZS)
Frame Format	Extended SuperFrame (ESF), SuperFrame (SF), or Unframed (UNFR)
Pulse Output	6 V <sup>pk-pk</sup> pre-equalized for 0 to 655 feet of ABAM cable
Input Level	+1.5 to -7.5 dB DSX

## System

One-way DS1 Delay	< 400 $\mu$ s
Wander (Looped)	Meets MTIE DS1.101 requirements
Wideband Jitter (Looped)	0.2 UI maximum
Narrowband Jitter (Looped)	0.1 UI maximum

## POWER CONSUMPTION

The three most important power parameters of an H2TU-C are its maximum power consumption, maximum power dissipation, and maximum current drain.

Table 26 describes line-powered and locally powered circuits on 9 kft, 26 AWG loops.

*Table 26. H2TU-C Power Parameters*

Remote Power Source	-48 Vdc Power Consumption (Watts)	Heat Dissipation (Watts)	-42.5 Vdc Current (mA)
	Maximum	Maximum	Maximum
Line-powered	12.0	7.0	286.0
Locally powered	8.6	6.7	205.0

## MAXIMUM POWER DISSIPATION

The maximum power dissipation measures the power that is converted into heat and contributes to the total heat generated in the space around the unit. It is used to determine the maximum number of fully loaded shelves per bay that does not exceed the maximum allowable power dissipation density in watts per square foot to comply with GR-63.

In COs, the maximum power dissipation for open-faced, natural convection-cooled mountings is limited to 134.7 watts per square foot in accordance with GR-63-CORE. The footprint of a standard 28-slot, 23-inch HCS-417 shelf is 7.024 square feet. Therefore, the maximum bay dissipation is limited to 946 watts. Use this limit and the parameters in Table 26 above to determine the maximum number of H2TU-C circuits that can occupy one CO bay.



**This is a worst case situation since it assumes the entire CO is subjected to the maximum power density. More favorable conditions would permit increasing the number of shelves per bay without jeopardizing the CO thermal integrity.**

The thermal loading limitations imposed when using the H2TU-C in a Controlled Environmental Vault (CEV) or in other enclosures are determined by applying its power parameters to the manufacturer's requirements for each specific housing.

The -48 Vdc power consumption is the maximum total power that the H2TU-C consumes or draws from the shelf power source. This parameter is needed when the H2TU-C is in a location remote to the CO it is serving. It determines the battery capacity required to maintain an 8-hour, standby battery reserve for emergency situations. Battery capacity, therefore, limits the maximum number of line units which can be installed in a remote enclosure. Perform this analysis using Table 26 above.

## MAXIMUM CURRENT DRAIN

The maximum current drain is the maximum current drawn from the shelf power supply when it is at its minimum voltage (-42.5 Vdc). This determines the shelf fusing requirements. Use the -42.5 Vdc current data in Table 26 above to determine the shelf fusing requirements for your H2TU-C applications.

## LOOP ATTENUATION AND INSERTION LOSS

Each loop has no more than 35 dB of insertion loss at 196 kHz, with driving and terminating impedances of 135Ω, as shown in Table 27 below. This is equivalent to a maximum of 28 dB loop attenuation.

Table 27. HDSL2 Reach Chart

Cable Gauge	Insertion Loss <sup>(a)</sup> at 196 kHz (dB/kft)	Loop Attenuation (dB/kft)	Maximum Reach (kft)	Ω per kft
26/0.4 mm	3.88	3.1	9	83
24/0.51 mm	2.84	2.2	12	52
22/0.61 mm	2.18	1.7	16	32
19/0.91 mm	1.54	1.2	23	16

(a) Insertion Loss = 1.25 times loop attenuation

## H2TU-C-202 CARD-EDGE CONNECTOR

Figure 35 shows the card-edge connector on the H2TU-C-202. Active pins are highlighted in black.

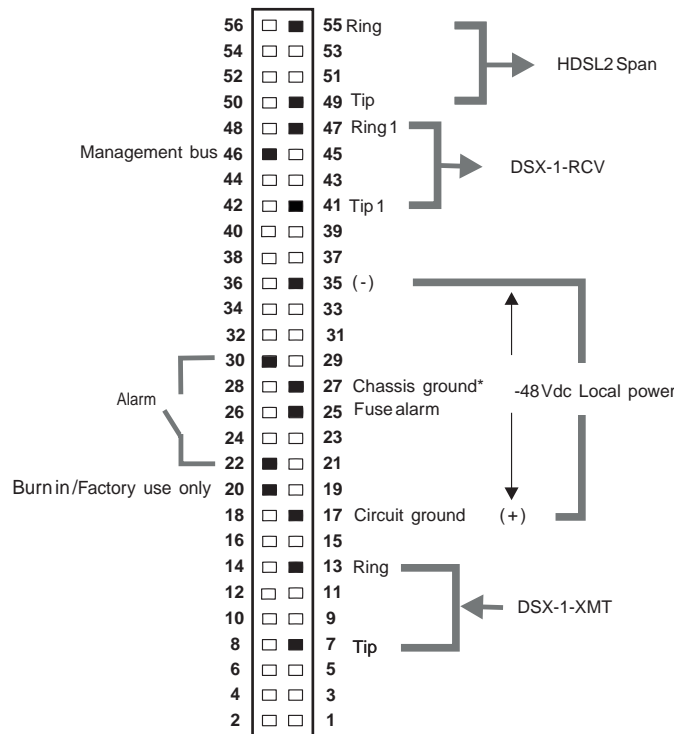

\* Chassis ground may be connected to Earth ground per local practice.

Figure 35. H2TU-C-202 List 2F Card-Edge Connector



The HDSL2 span is accessed on pins 55 and 49 which are assigned to Loop 2 in 4W HDSL circuits.



## Network Management Control Bus

The H2TU-C provides a Network Management Control Bus on pin 46 of the card-edge connector. This allows the various ADC Management System protocols to manage the H2TU-C through the H2TU-319 HiGain Management Unit.



Some H2TU-C-202 List 2F features are affected when it is under management control. Consult the management unit practice for further information. See “Appendix D - Product Support” on page 68.

## Fuse Alarm

Pin 25 on the card-edge connector is a fuse alarm that is driven to -48 Vdc through a 1000Ω resistor whenever its onboard fuse opens.

## System Alarm Output Pins

Pins 22 and 30 on the card-edge connector shown in Figure 35 on page 64 are the H2TU-C-202 List 2F System Alarm output signals.

## CRAFT PORT

Figure 36 below shows the pinout for the craft port connector and its connection to a DB-9 or DB-25 connector on a maintenance terminal.

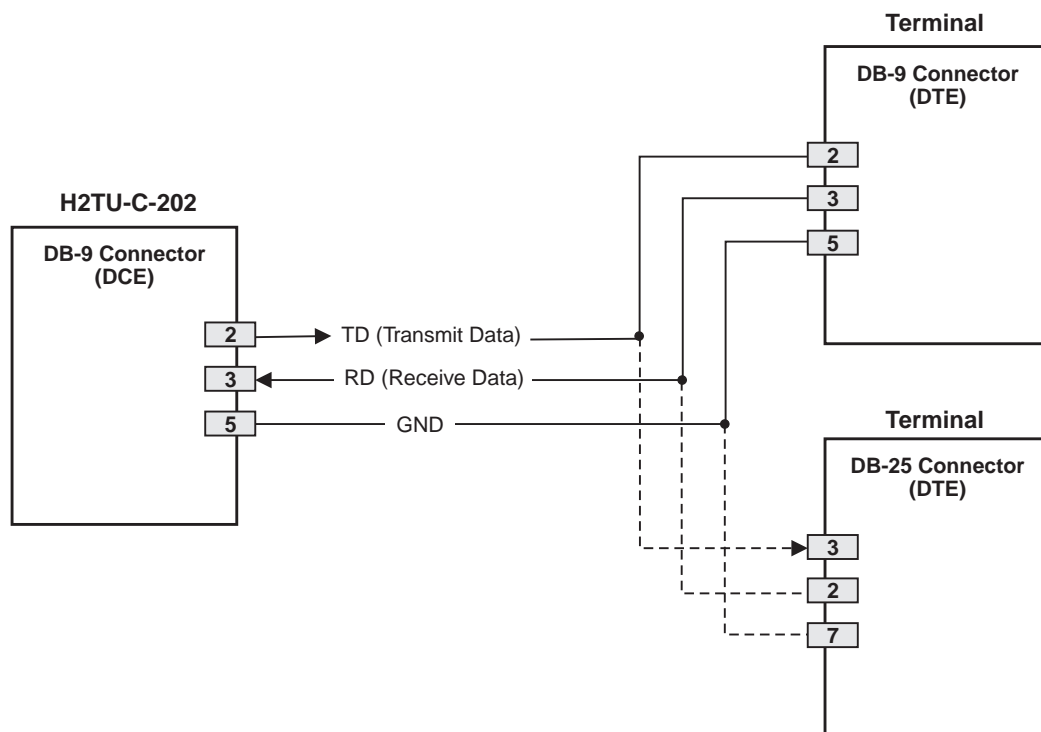

**Figure 36.** RS-232 Craft Port Pinouts

# APPENDIX B - FUNCTIONAL OPERATION

ADC HDSL2 technology provides full-duplex services at standard DS1 rates over copper wires between an H2TU-C and an H2TU-R, which comprise one HiGain HDSL2 system. HiGain HDSL2 systems use Overlapped Pulse Amplitude Modulation Transmission with Interlocking Spectra (OPTIS) transceiver systems to establish full-duplex, 1.552 kbps data channels between the H2TU-C-202 List 2F and a remotely located H2TU-R.

Figure 37 shows a block diagram of the H2TU-C-202 List 2F. The H2TU-C-202 List 2F receives a 1.544 Mbps DSX-1 data stream from the DSX-1 digital cross-connect interface. The H2TU-C contains a DS1 frame synchronizer controlled by an 8-bit microprocessor that determines the type of framing on the DS1 stream. The H2TU-C synchronizes to the type of framing detected. The H2TU-C recognizes SuperFrame (SF), including D4 or Extended SuperFrame (ESF).

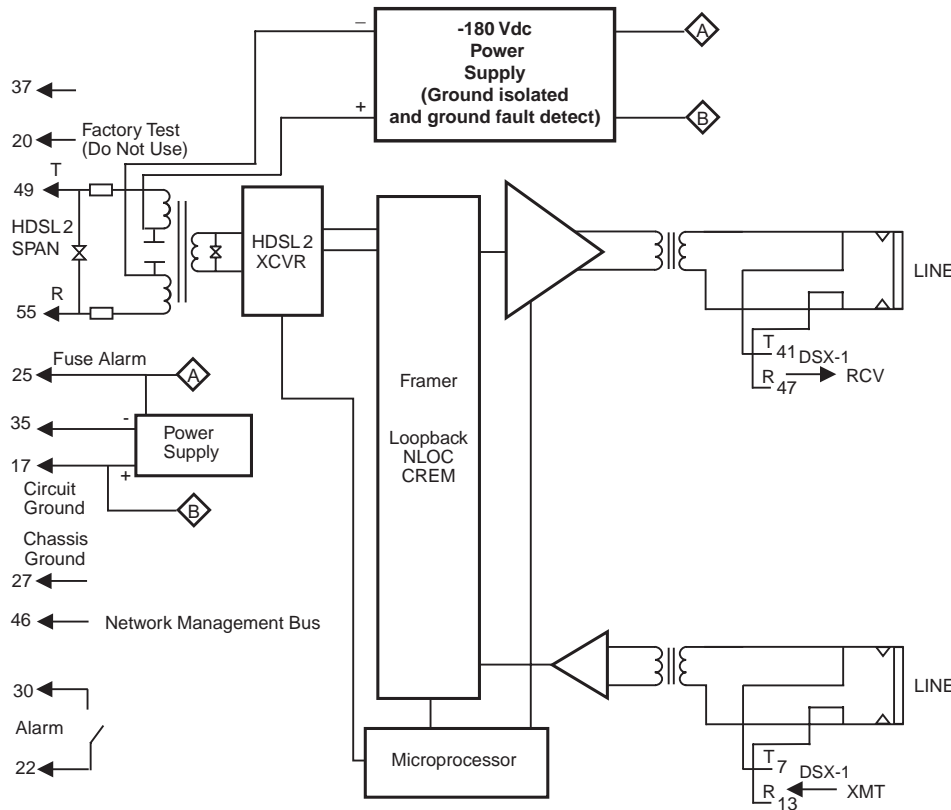

Figure 37. H2TU-C-202 List 2F Block Diagram

## TIMING

The low-loop wander (0.5 UI max) of an H2TU-C, when used with remote units, allows the circuit to be used in all critical timing applications, including those used to transport Stratum 1 timing.

## GROUND FAULT DETECT

The H2TU-C has a Ground Fault Detect (GFD) circuit which detects a ground or a resistive path to ground on any wire of the HDSL2 loop. This makes the product compliant with the Class A2 requirements of GR-1089.

# APPENDIX C - COMPATIBILITY

The HiGain system uses HDSL2 transmission technology as recommended by ANSI committee in compliance with the ANSI T1.418-2000 HDSL2 standards. HiGain HDSL2 complies with GR-63-CORE, TR-TSY-000499, and GR-1089-CORE.

## COMPATIBLE SHELVES AND ENCLOSURES

The H2TU-C-202 List 2F is compatible with the following 200 and 400 mechanics, high-density shelf enclosures:

- Indoor enclosures
  - HiGain Remote Enclosure HRE-425 (12-slot)
  - HRE 422 (2-slot)
  - HRE- 204 (4-slot)
  - HRE-420 (1-slot)
- Shelves
  - HiGain Card Shelf HCS-340 (3-slot)
- Outdoor enclosures
  - HRE-454 (4-slot)

# APPENDIX D - PRODUCT SUPPORT

ADC Customer Service Group provides expert pre-sales and post-sales support and training for all its products. Technical support is available 24 hours a day, 7 days a week by contacting the ADC Technical Assistance Center.

## Sales Assistance

800.366.3891 extension 73000  
(USA and Canada)  
952.917.3000  
Fax: 952.917.3237

- Quotation Proposals
- Ordering and Delivery
- General Product Information

## Systems Integration

800.366.3891, extension 73000 (USA and Canada)  
952.917.3000

- Complete Solutions (from concept to installation)
- Network Design and Integration Testing
- System Turn-Up and Testing
- Network Monitoring (upstream or downstream)
- Power Monitoring and Remote Surveillance
- Service/Maintenance Agreements
- Systems Operation

## ADC Technical Assistance Center

800.638.0031  
714.730.3222  
Fax: 714.730.2400  
Email: [wsd\\_support@adc.com](mailto:wsd_support@adc.com)

- Technical Information
- System/Network Configuration
- Product Specification and Application
- Training (product-specific)
- Installation and Operation Assistance
- Troubleshooting and Repair/Field Assistance

## Online Technical Support

- [www.adc.com/technical](http://www.adc.com/technical) support

## Online Technical Publications

- [www.adc.com/documentation](http://www.adc.com/documentation) library/ technical publications

## Product Return Department

800.366.3891 ext. 73748 or  
952.917.3748  
Fax: 952.917.3237  
Email: [repair&return@adc.com](mailto:repair&return@adc.com)

- ADC Return Material Authorization (RMA) number and instructions must be obtained before returning products.

All telephone numbers with an 800 prefix are toll-free in the USA and Canada.

# APPENDIX E - ABBREVIATIONS

## A

<b>ACO:</b>	Alarm Cutoff
<b>ADSL:</b>	Asymmetrical Digital Subscriber Line
<b>AIS:</b>	Alarm Indication Signal
<b>ALM:</b>	Alarm
<b>ALMP:</b>	Alarm Pattern
<b>ANSI:</b>	American National Standards Institute
<b>AOR:</b>	Addressable Office Repeater
<b>ARM:</b>	Armed
<b>AUTO:</b>	Auto-Framing Mode
<b>AWG:</b>	American Wire Gauge

## B

<b>BER:</b>	Bit Error Rate
<b>BPV:</b>	Bipolar Violation
<b>BPVT:</b>	Bipolar Violation Transparency

## C

<b>CEV:</b>	Controlled Environmental Vault
<b>CLEI:</b>	Common Language Equipment Identifier
<b>CLOC:</b>	Customer Local Loopback
<b>CONV:</b>	Conversion
<b>CRC:</b>	Cyclical Redundancy Check
<b>CREM:</b>	Customer Remote Loopback
<b>CSA:</b>	Carrier Service Area
<b>CV:</b>	Code Violation
<b>CV-P:</b>	Code Violation-Path

## D

<b>DBER:</b>	DS1 Bit Error Rate
<b>DIS:</b>	Disabled
<b>DL:</b>	Datalink
<b>DLC:</b>	Digital Loop Carrier
<b>DSX-1:</b>	Digital Signal Cross-Connect, Level 1

## E

<b>ECI:</b>	Equipment Catalog Item
<b>ENA:</b>	Enabled
<b>EQL:</b>	Equalization
<b>ESD:</b>	Electrostatic Discharge
<b>ESF:</b>	Extended SuperFrame
<b>ES-L:</b>	Errored Seconds-Line
<b>EXZ:</b>	The occurrence of 8 consecutive zeroes for B8ZS or 16 for AMI.

## F

<b>FCON:</b>	Frame Conversion
<b>FDL:</b>	Frame Bit for Datalink
<b>FE:</b>	Far End
<b>FPS:</b>	Framing Pattern Sequence

## H

<b>HCDS:</b>	High Capacity Digital Service
<b>HDSL:</b>	High-bit-rate Digital Subscriber Line
<b>HDSL2:</b>	High-bit-rate Digital Subscriber Line 2
<b>HG:</b>	HiGain

## I

<b>ILR:</b>	Intelligent Line Repeater
<b>IN:</b>	Transmit
<b>IOR:</b>	Intelligent Office Repeater
<b>IR:</b>	Intelligent Repeater

## L

<b>LA:</b>	Loop Attenuation
<b>LAIS:</b>	Line Alarm Indication Signal
<b>LBPV:</b>	Local Bipolar Violation
<b>LED:</b>	Light Emitting Diodes
<b>LLOS:</b>	Line (Unit) Loss of Signal
<b>LOS:</b>	Loss of Signal
<b>LOSW:</b>	Loss of Sync Word

**LPDN:** Loopdown  
**LPF:** Line Power Feed

**M**

**MAL:** Margin Alarm  
**MARG:** Margin  
**MNGD:** Managed  
**MSEC:** Monitored Seconds

**N**

**NE:** Near End  
**NEBS:** Network Equipment-Building System  
**NI:** Network Interface  
**NID:** Network Interface Device  
**NLOC:** Network Local Loopback  
**NMA:** Network Management and Administration  
**NPRM:** Network PRM  
**NREM:** Network Remote Loopback  
**NTF:** No Trouble Found

**O**

**OOF:** Out-of-Frame  
**OPTIS:** Overlapped PAM Transmission with Interlocking Spectra

**P**

**PBOC:** Power Back Off - Customer  
**PBON:** Power Back Off - Network  
**PL:** Payload  
**PM:** Performance Monitoring  
**POTS:** Plain Old Telephone Service  
**PRM:** Performance Report Messaging  
**PRM-FE:** Performance Report Messaging - Far End  
**PRM-NE:** Performance Report Messaging - Near End

**R**

**RAI-CI:** Remote Alarm Indication-Customer Installation  
**RAIS:** Remote Alarm Indication Signal  
**RDA:** Remote Disconnect Alarm

**RLOS:** Remote (Unit) Loss of Signal  
**ROVR:** RAI Overwrite  
**RRAI:** Remote RAI

**S**

**SDSL:** Symmetrical Digital Subscriber Line  
**SES:** Severely Errored Seconds  
**SES-L:** Severely Errored Seconds-Line  
**SES-P:** Severely Errored Seconds-Path  
**SF:** SuperFrame  
**SMJK:** SmartJack  
**SNET:** Southern New England Telephone  
**SPLB:** Special Loopback  
**SPRM:** Supplemental PRM

**T**

**TLOS:** Transmit Loss of Signal

**U**

**UAS:** Unavailable Seconds  
**UAS-P:** Unavailable Seconds-Path  
**UNFR:** Unframed

**X**

**XMT:** Transmit

---

# CERTIFICATION AND WARRANTY

## FCC CLASS A COMPLIANCE

This equipment has been tested and found to comply with the limits for a Class A digital device, pursuant to Part 15 of the FCC Rules. These limits are designed to provide reasonable protection against harmful interference when the equipment is operated in a commercial environment. This equipment generates, uses, and can radiate radio frequency energy and, if not installed and used in accordance with the instruction manual, may cause harmful interference to radio communications. Operation of this equipment in a residential area is likely to cause harmful interference in which case the user will be required to correct the interference at his own expense.

## LIMITED WARRANTY

Product warranty is determined by your service agreement. Contact your sales representative or Customer Service for details.

## RETURNS

ADC continues to repair faulty modules beyond the warranty program at a nominal charge. Contact your ADC sales representative for details and pricing.

## MODIFICATIONS

Any changes or modifications made to this device that are not expressly approved by ADC DSL Systems, Inc. voids the user's warranty. All wiring external to the products should follow the provisions of the current edition of the National Electrical Code.

## SAFETY STANDARDS COMPLIANCE

The H2TU-C-202 List 2F has been tested and verified to comply with the applicable sections of the following safety standards:

- GR 63-CORE - Network Equipment-Building System (NEBS) Requirements
- GR 1089-CORE - Electromagnetic Compatibility and Electrical Safety
- Binational standard, UL-1950/CSA-C22.2 No. 950-95: Safety of Information Technology Equipment

For technical assistance, refer to "Appendix D - Product Support" on page 68.

---

**ADC DSL Systems, Inc.**

14402 Franklin Avenue  
Tustin, CA 92780-7013

Tel: 714.832.9922

Fax: 714.832.9924

**Technical Assistance**

Tel: 800.638.0031

Tel: 714.730.3222

Fax: 714.730.2400

DOCUMENT: LTPH-UM-1072-03



1249004